

OWNER'S MANUAL

MUSSO & MUSSO GRAND



Recommended Fluids and Lubricants

Descriptions			Capacity	Specifications	
Engine Oil	D22DTR	EU	≈ 6.0ℓ	Quality class: KG Mobility genuine engine oil or ACEA C2 SAE 0W-30	
		GEN	≈ 6.0ℓ	Quality class: KG Mobility genuine engine oil or ACEA C2 SAE 0W-30 or MB 229.51 SAE 5W-30	
	G20DTR	≈ 5.0ℓ	Quality class: KG Mobility genuine engine oil or ACEA C2 SAE 0W-30 or MB 229.51 SAE 5W-30		
Urea solution		D22DTR	≈ 20.0ℓ	ISO 22241 or DIN 70070	
Engine Coolant		D22DTR	≈ 10.2ℓ	KG Mobility genuine coolant	
		G20DTR	≈ 11.0ℓ	Anti-Freeze SYC-1025, Anti-Freeze:Water = 50:50 ORGANIC ACID TYPE, COLOR:BLUE	
Automatic Transmission Fluid		6A/T	≈ 9.6ℓ	KG Mobility genuine oil (NWS-9638)	
Manual Transmission Fluid		6M/T	≈ 2.2ℓ	KG Mobility genuine oil (HD MTF 75W/85 (SHELL) or HK MTF 75W/85 (SK))	
Transfer Case Fluid		Part Time	≈ 1.4ℓ	KG Mobility genuine oil (ATF DEXRON II or III)	
Axle Oil	Front		≈ 1.4ℓ	KG Mobility genuine oil (API GL-5 & SAE 80W/90)	
	Rear	5-LINK	LD		≈ 1.8ℓ
			NON-LD		≈ 2.0ℓ
		LEAF	LD		≈ 2.8ℓ
			NON-LD		≈ 3.0ℓ
Brake / Clutch Fluid			As required	KG Mobility genuine oil (DOT4)	
Power Steering Fluid			≈ 1.1ℓ	KG Mobility genuine oil (S-PSF4) * TOTAL FLUIDE DA (Extreme cold condition only)	
Tailgate Hinge Spring Oil			As required	Heat fluorine resistance grease (PTFE Grease, refer to KS M 2130)	

D22DTR: Diesel 2.2, G20DTR: Gasoline 2.0



Warning

- Use only KG Mobility recommended fluids and lubricants.
- Do not mix any different types or brands of oils or fluids. This may cause damages.
- Keep the specified levels when adding or replacing the fluids.

Notice

- The antifreeze mixture ratio at the time of vehicle delivery is 45%.

Foreword

This section provides useful information to know in advance for reading the owner's manual.

Information regarding the marks used in the owner's manual, change of car design, and periodic check is provided.

Thank you for purchasing the MUSSO & MUSSO GRAND.

The MUSSO & MUSSO GRAND you selected is a vehicle with superior safety and quality and the latest technologies. KG Mobility Corporation has been carrying out and initiating R&D activities continuously in the industry.

Please read this owner's manual carefully before driving the MUSSO & MUSSO GRAND. You can drive safely and economically by utilizing the technical advantages applied to the vehicle.

We will dedicate ourselves to ensure that you can always drive the MUSSO & MUSSO GRAND pleasantly and safely.



Purpose and Application Conditions of the Owner's manual

This owner's manual has been prepared to provide information for the specifications and functions of the vehicle, and important safety information including cautions and warnings for safe driving and correct vehicle maintenance.

- All descriptions, pictures, and drawings included in this owner's manual are based on the time of the document's preparation. If there is a change in the specifications (options) and functions according to a change of design, some content may be different from the actual vehicle.
- This owner's manual has been prepared based on all specifications (options) of the vehicle. Please understand that an explanation of a specification (options) which is not provided for your vehicle may be provided.

As some options or option packages may be added or deleted randomly depending on the vehicle point of sale and design changes, make sure that the options you applied when signing the contract are fitted to your vehicle prior to reading this owner's manual.

Please read this owner's manual carefully before driving the vehicle, to ensure safe driving and the best vehicle performance.

Open Source Software Notice Information

To obtain the source code under GPL, LGPL, MPL, and other open source licenses, that is contained in this product, please visit <http://opensource.lge.com>.

In addition to the source code, all referred license terms, warranty disclaimers and copyright notices are available for download.

LG Electronics will also provide open source code to you on CD-ROM for a charge covering the cost of performing such distribution (such as the cost of media, shipping, and handling) upon email request to opensource@lge.com.

This offer is valid for a period of three years after our last shipment of this product. This offer is valid to anyone in receipt of this information.

Marks Used in this Owner's manual



DANGER

It indicates a dangerous situation (DANGER) that may likely lead to death or serious injury.

It should be observed for the safety of the driver and other passengers.



WARNING

It indicates a dangerous situation (WARNING) that may lead to death or serious injury.

It should be observed for the safety of the driver and other passengers.

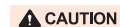

CAUTION

It indicates a dangerous situation (CAUTION) that may lead to moderate or minor injury, or a situation that may lead to damage to the vehicle.

It should be observed for the safety of the driver and other passengers and the prevention of property damage.

NOTICE

It is used for explaining additional information or procedures related to the vehicle and driving.



It is used to indicate the location of relevant information useful for using the product.

Change of Specifications (options) and Functions According to a Change of Design

The design is subject to change without prior notice for improving the safety and performance of the vehicle. Therefore, a vehicle specification (options) may be added or deleted, or a function may change.

The content explained in this owner's manual may be different from your vehicle.

Do Not Use Vehicle Components for Other Purposes

Do not use vehicle components for other purposes. KG Mobility Corporation is not liable for any consequent damages.

Importance of a Periodic Check

Have your vehicle checked and maintained at a prescribed period in order to maintain the performance of the vehicle and to prevent the reduction of its life.

Information for Using KG Mobility Authorized Service Centers

KG Mobility Corporation is not liable for any problem that occurred due to maintenance carried out by a service center other than KG Mobility authorized service centers.

Table of Contents

The table of contents is provided in three types to allow you to find necessary information in a convenient method easily and fast.

- Introduction to chapters - You can identify the content of each chapter at a glance.
- Detailed table of contents - You can find desired information using a name through the detailed title for the relevant chapter.
- Table of pictures - You can find desired information using a picture easily even if you do not know the title of the desired information.

Introduction to Chapters

Identify the contents of each chapter at a glance.

Foreword

- You can check information regarding the marks used in the instruction manual, change of car design, and periodic check.

1. Vehicle Information and Safety Precautions

- You can check helpful information for driving and managing the vehicle safely and conveniently.
- Information regarding the vehicle identification, specifications, check points before driving the vehicle, safety precautions while driving, and vehicle maintenance methods is provided.

2. Safety Units

- You can check information regarding devices that allow you to drive the vehicle safely and how to use such devices.
- An explanation is provided for seat belts, a baby car seat, airbags, anti-theft, and warning system.

3. Convenient Equipment

- You can check information regarding devices that allow you to drive the vehicle conveniently and usefully and how to use such devices.
- An explanation is provided for doors, seats, windows, as well as various convenient equipment including the tailgate, various lights and lamps, mirrors, heater and A/C, AV navigation, storage and cargo box.

4. Starting and driving

- You can check information regarding the basic auxiliaries for safe driving, auxiliary equipment that helps you to drive comfortably, and how to use such equipment.
- An explanation is provided for the START/STOP switch and smart key as well as the driving system including the instrument cluster, gear shift lever, 4WD, cruise control, auxiliary driving system such as the brake and autonomous emergency braking system, rear and side warning lane departure warning system, and parking assistance system.

5. Emergency Measures in the Event of Emergency

- You can check useful information and emergency measures for various emergency situations you can face while driving.
- Information regarding the warning triangle and OVM tools, and a correct measure in case of a dead battery, engine overheating, flat tire, and towing a vehicle is provided. An explanation is also provided for how to respond to a fire, heavy snow, vehicle trouble, and an accident safely.

6. Periodic Checking and Maintenance

- You can check the necessary periodic check and maintenance methods in detail for safe and pleasant vehicle driving.

Index

- You can find important functions or terms from the content of this instruction manual in alphabetical order conveniently.

Detailed Table of Contents

Find the desired information using a name through detailed titles.

1. Vehicle Information and Safety Precautions

Information regarding the installation of ADR and provision of information	1-2
Precautions for potentially hazardous seat belt related goods	1-3
Precautions for the reduction of non-crash incidents	1-4
Cautions for the protection of the environment	1-5
Certification	1-6
Vehicle identification	1-9
Certification label	1-9
Vehicle Identification Number (VIN).....	1-9
Vin Label	1-9
Engine number	1-9
Dimensions (MUSSO Type-A)	1-10
Dimensions (MUSSO Type-B)	1-11
Dimensions (MUSSO GRAND Type-A)	1-12
Dimensions (MUSSO GRAND Type-B)	1-13

Specifications	1-14
Precautions for the modification of the vehicle and structural alteration	1-18
Checking before driving	1-20
Daily inspection	1-20
Checking engine room	1-20
Checking engine coolant	1-20
Checking engine oil	1-20
Checking brake fluid	1-21
Checking power steering oil	1-21
Checking washer fluid.....	1-21
Checking belts.....	1-21
Checking tires.....	1-21
Checking the instrument cluster	1-22
Checking the parking brake.....	1-22
Checking the pedals	1-22
Cleaning up near the driver's seat.....	1-23
Advisable driving position	1-23
Adjusting the seat, headrest, steering wheel, and mirrors	1-23
Wearing the seat belt correctly	1-24
Safety and cautions for driving	1-25
No drugged, drunk, distracted and drowsy (4D) driving.....	1-25

Cautions for air bag.....	1-25
Precautions for infants, children, old people, or pregnant women	1-26
An infant or a small child must be seated in the rear seat with protective gear.....	1-26
No sleeping in a sealed vehicle	1-26
Do not drive with the doors or tailgate open	1-27
Do not hold a part of your body out of the window or sunroof	1-27
Be careful not to have a part of your body caught when using the power window	1-27
Check for any vehicles or persons passing by when getting out	1-28
Safe parking and stopping.....	1-28
Warming up the engine correctly	1-28
Do not stop the engine while driving.....	1-29
No sudden starting, acceleration or braking	1-29
Driving on unpaved and mountain roads.....	1-29
In high mountain area.....	1-29
Driving on a snowy or icy road	1-29
Driving on a sandy or muddy road	1-30

Driving on a hillside road and downhill road	1-30	Long-term parking mode	1-34	Engine check indicator	1-41
Driving on a road with a pool of water or a river	1-30	Breaking in a new vehicle correctly	1-34	Other maintenance	1-42
Do not use a cellular phone or watch DMB including DVD while driving	1-31	Using genuine parts	1-34	Diesel fuel in winter	1-42
Driving on the expressway	1-31	Vehicle washing	1-35		
Crossing an intersection or railroad crossing	1-31	Washing the bumper	1-36		
No sudden maneuvering of the steering wheel	1-31	Washing wheels	1-36		
Do not warm up the engine or check the vehicle in a sealed space	1-31	Cautions for polishing the vehicle	1-36		
Do not load hazardous materials	1-32	Cleaning and maintaining glass	1-37		
Use of the engine brake	1-32	Cautions for window tinting	1-37		
Special cautions when checking the coolant	1-32	Care and cleaning of the interior	1-37		
Cautions for attaching accessories	1-32	Seat Belt Care	1-38		
Cautions for vehicle ventilation	1-32	Cautions for using the vehicle key	1-38		
System protection function (delayed accelerator pedal response)	1-33	Corrosion protection	1-38		
Placement of extinguisher	1-33	Sheet Metal Damage	1-38		
Vehicle management	1-34	Foreign Material Deposits	1-38		
KG Mobility authorized service centers and maintenance partners	1-34	Finish Damage	1-39		
Cautions for the depletion of battery when connecting uninterruptible power supply to the black box system	1-34	Underbody Maintenance	1-39		
		System safety mode	1-40		
		Vehicle Fueling from Drums or Storage Containers	1-40		
		Fuel recommendation	1-40		
		Diesel Engine	1-40		
		Gasoline Engine	1-40		
		Fuel Recommendation	1-40		
		Do not Use Methanol	1-41		
		Using biodiesel fuel and low quality fuel	1-41		

2. Safety Units

Seat belt..... 2-2

Seat belt warning.....2-2

Front seat (driver / passenger*) belt reminder.....2-3

Rear seat (left / center / right) belt reminder*2-3

Fastening the seat belt2-4

Unfastening the seat belt2-5

Managing the seat belt2-5

Adjusting the height of the front seat belt2-5

Stowing the rear seat belt2-5

Stowing the rear buckle.....2-6

How to fasten the seat belts (2-point) in rear seat2-6

Seat belt pretensioner and load limiter....2-7

Pretensioner2-7

Load limiter2-7

Fastening the seat belt by a pregnant woman2-8

Warnings for the seat belt2-8

Child restraint for an infant or a small child* 2-10

Infant and child safety..... 2-11

Child Seat..... 2-11

Table of Vehicle Handbook Information on Child Restraint Systems Installation Suitability for Various Seating Positions 2-11

Installation of crs secured by the seatbelt..... 2-12

Front-facing Child Seat..... 2-12

Rear-facing Child Seat 2-12

Securing a child restrain system with "ISOFIX" system 2-13

How to use the ISOFIX Lower Latch Anchor 2-13

How to use the Rear Anchor 2-14

Cautions for ISOFIX Seat..... 2-14

Table of Vehicle Handbook Information on ISOFIX Child Restraint Systems Installation Suitability for Various ISOFIX Positions 2-16

List of suitable universal Child Restraint Systems (CRS) 2-17

List of suitable ISOFIX Child Restraint Systems (CRS)..... 2-17

Warning For Child Restraint..... 2-17

Air bag* 2-18

Air bag warning label..... 2-18

Air bag warning lamp 2-18

Air bag crash sensor and air bag control module 2-19

Configuration of air bag 2-19

Passenger Air Bag ON/OFF Switch..... 2-19

Driver air bag 2-20

Front passenger air bag 2-20

Front seat side air bag 2-20

Curtain air bag..... 2-21

Cases where the air bag does not inflate 2-21

In the event of a slight collision 2-21

In the event of a rear end collision 2-22

In the event of a side collision 2-22

In the event of a diagonal collision 2-22

In the event of a collision with a narrow object 2-23

In case the vehicle moves beneath another vehicle 2-23

In the event of a rollover accident 2-23

Secondary injury due to air bag deployment 2-24

Other cases 2-24

Cases where the driver/front passenger air bags do not inflate .. 2-24

Cases where the side air bags or curtain air bags do not inflate 2-24

Warnings for the air bag..... 2-24

Tire pressure monitoring system (TPMS)* 2-26

Checking the tire pressure 2-26

If the tire pressure or the TPMS is abnormal 2-27

Display of the TPMS status on the instrument cluster 2-28

When low tire pressure is detected 2-30

When you have rotated the tires 2-30

Cautions for the TPMS 2-31

Anti-theft and warning system 2-32

Immobilizer system 2-32

Immobilizer/smart key warning light 2-32

If the engine does not start..... 2-33

When the transponder is damaged... 2-33

When you lose the key..... 2-33

Theft deterrent system..... 2-34

Entering the theft monitoring mode... 2-34

Activating the theft alarm 2-34

Canceling the theft monitoring mode 2-35

3. Convenient Equipment

Door 3-2

Locking, unlocking and opening the door 3-2

Door lock/unlock lever	3-2	Adjusting the front passenger seat manually	3-10	Opening/closing the rear seat window ..	3-18
Door open lever	3-2	Adjusting the front and rear positions	3-10	Rear seat window lock function	3-19
Door Lock/Unlock button	3-2	Adjusting the angle of the backrest	3-10	Sunroof*	3-20
Auto door lock function at the time of driving	3-3	Seat height adjustment (Driver)	3-10	Opening/closing sun shade blind	3-21
Auto door unlock function at the time of collision	3-3	Rear seat	3-11	Opening the sunroof	3-21
Child safety door lock	3-4	Seatback Release Lever	3-11	Opening automatically	3-21
Locking/unlocking the door lock	3-4	Head Restraint Adjustment	3-11	Manual open	3-21
Seat	3-5	Folding rear seatback	3-12	Closing the sunroof	3-22
Configuration	3-5	Seat ventilation and heating*	3-13	Closing automatically	3-22
Front seat	3-6	Front seat ventilation	3-13	Closing manually	3-22
Adjusting the headrest	3-6	Front seat heating	3-14	Sunroof open warning	3-22
Adjusting the front and rear angles	3-6	Smart front seat heating control	3-14	Resetting the sunroof	3-22
Adjusting the height	3-6	Rear seat heating switch* (same for both sides)	3-15	Cases requiring the resetting of the sunroof	3-22
Separation/installation	3-7	Warnings and cautions related to the seats	3-16	Resetting	3-23
Adjusting the power seat*	3-7	Window (power window)	3-17	Loading goods	3-24
Front and rear position adjustment (driver seat/front passenger seat)	3-7	Opening/closing the driver seat/front passenger seat window	3-17	Tailgate opening/closing	3-24
Adjusting the height (driver seat/front passenger seat)	3-8	Opening the driver seat/front passenger seat window	3-17	Opening Tailgate	3-24
Adjusting the cushion angle (driver seat)	3-8	Closing the driver seat/front passenger seat window	3-17	Closing Tailgate	3-24
Adjusting the backrest angle (driver seat/front passenger seat)	3-8	Driver seat window safety function ..	3-18	Loading goods on the deck	3-25
Adjusting the lumbar support (driver seat)	3-9			Engine hood	3-28
				Opening the engine hood	3-28
				Closing the engine hood	3-28
				Checking before closing the engine hood	3-28
				Closing the engine hood	3-28
				Fuel inlet	3-29

Opening the fuel inlet	3-29		
Closing the fuel inlet	3-30		
Lights and lamps	3-31		
Outdoor lights/lamps	3-31		
Light switch	3-33		
Turning on the head light	3-33		
Turning on the tail light	3-33		
Activating the auto light function ...	3-33		
Turning off all lights	3-33		
Turning on the front fog light*	3-33		
Turning on the rear fog light*	3-33		
Turning off the front fog light	3-33		
Turning on/off the left/right turn signal	3-33		
Turning on/off the high beam	3-34		
Turning on the high beam and low beam at the same time (passing light)	3-34		
Hazard warning lamp	3-34		
Adjusting the angle of the head light	3-35		
Angle adjustment levels of the head light	3-35		
Angle adjustment standard for the head light	3-36		
Daytime Running Light (DRL)*	3-36		
In case the DRL turns on	3-37		
In case the DRL turns off	3-37		
Smart High Beam (SHB)*	3-37		
Setting the SHB	3-37		
In case the high beam turns on ...	3-38		
In case the high beam turns off ...	3-38		
Operating the Light switch	3-39		
Welcome light	3-39		
Coming-Home Light Control	3-40		
Coming-home light ON	3-40		
Coming-home light OFF	3-40		
Leaving-Home Light Control	3-40		
Leaving-home light ON	3-40		
Leaving-home light OFF	3-40		
Setting the coming home/leaving home light	3-40		
Auto light function*	3-40		
Auto light sensor	3-41		
Interior lamp	3-42		
Front room lamp (overhead console)	3-43		
Driver seat spot switch	3-43		
Front passenger seat spot switch	3-43		
Driver / passenger / center room lamp spot switch	3-43		
Door linkage switch	3-43		
Front spot lamp	3-43		
Linkage function between the smart key and the front room lamp	3-43		
Center room lamp	3-44		
Sun visor/mirror lamp	3-44		
			Door courtesy lamp (front seats)
			Mood lamp*
			Glove box lamp
			Wiper and washer fluid
			Windshield wiper
			Adjusting the operation speed of the windshield wiper
			Front windshield and washer fluid linkage
			Front auto washer
			Rain sensing wiper*
			Rain sensor
			Mirror
			Outside rearview mirror
			Folding/unfolding the outside rearview mirror
			Auto folding/unfolding function ...
			Adjusting the outside rearview mirror
			Selecting the outside rearview mirror
			Adjusting the angle of the outside rearview mirror
			Interior mirror
			ECM room mirror*
			Manual type inside rearview mirror
			Manual Day/Night Adjustment
			Heater and air conditioner*

Adjusting the direction of air distribution and fan speed	3-51
Cautions for using the heater and air conditioner	3-52
Replacing A/C refrigerant/oil	3-52
Heater and A/C controller*	3-54
Turning Heater & A/C ON/OFF	3-55
Driver/Passenger Side Temperature Control	3-55
Independent Temperature Control (SYNC Off)	3-55
Temperature Synchronization Control (SYNC On)	3-56
AUTO Mode	3-56
Manual Mode	3-56
Air Distribution	3-57
Activating glass heater	3-58
How to Dehumidify Window Glass	3-58
Auto defogger system	3-59
Auto Defogger System	3-59
Operation levels of auto defogger system	3-59
Eco Mode	3-60
Heater and A/C controller (manual)	3-61
Setting/operating the heater and air conditioner	3-62
Controlling the fan speed	3-62
Controlling the temperature	3-62
Defrosting and defogging	3-63

Switching between recirculation mode and fresh air mode	3-63
MAX A/C switch	3-63
Selecting the direction of air distribution	3-64
Operating the glass heater	3-64
Removing moisture on the glass	3-65

Steering wheel..... 3-66

Adjusting the height/length of the steering wheel	3-66
Steering wheel heater*	3-66
Horn	3-66

Infotainment system* 3-67

Smart audio	3-67
MP3 audio system	3-68
AV/Navigation	3-68
Slots for multimedia	3-68
Operating from the steering wheel	3-69
Voice recognition function	3-69
Controlling the volume	3-69
Bluetooth hands-free	3-69
Mute	3-69
Selecting the mode	3-69
Searching for media (SEEK)	3-70
Antenna*	3-70

Power socket..... 3-71

Front	3-71
-------------	------

Cigarette lighter* 3-72

USB charging port 3-73

Indoor convenient equipment 3-74

Sun visor and card holder (driver seat)	3-74
Sun visor	3-74
Card holder	3-74
Mirror and lamp	3-74
Grip handle/coat hanger	3-75
Front seat side grip handle	3-75
Side grip handle on the rear seats	3-75
Rear tray*	3-75

Storage unit..... 3-76

Front seat/rear seat cup holder	3-76
Front storage	3-76
Glove box	3-77
Console	3-77
Door map pocket	3-78
Seat backrest pocket	3-78

Roof rack* 3-79

4. Starting and driving

Starting the engine and driving the vehicle 4-2

Engine starting (REKES)	4-2
-------------------------------	-----

Engine starting (Smart key)	4-2
Driving off	4-3
Stopping the engine	4-4
Functions of ignition key	4-6
Unlocking the Steering Wheel	4-6
Key Hole Illumination	4-6
Key Reminder	4-6
when starting the engine	4-7
Battery replacement for REKES	
key	4-8
Replacing Procedures:	4-8
START/STOP switch	4-9
OFF status	4-9
ACC status	4-9
ON status	4-9
READY status	4-9
Starting the engine	4-10
Starting the engine	4-10
Restarting the engine when it cannot be started	4-10
Starting the engine in winter	4-11
Stopping the engine	4-11
Stopping the engine while driving (in the event of emergency)	4-12
System safety mode	4-12
Cautions for using the START/STOP switch	4-12

Remote control key and ignition	
key	4-14
Smart key*	4-17
Additional functions of smart key*	4-19
Smart Door AUTO Lock (AUTO Close)	4-19
Activating the smart door auto lock function (Activating from the instrument cluster)	4-19
Activating the smart door auto lock function (Activating with the smart key)	4-19
Locking/unlocking the door with the door handle switch (Type A)	4-20
Locking the door with the touch sensor	4-20
Unlocking the door with the touch sensor	4-21
Cautions for using the smart key system (touch sensor)	4-22
Locking/unlocking the door with the door handle switch (Type B)	4-23
To lock with door handle switch	4-23
Door Outside Handle Switch Unlock (Safety UNLOCK disabled)	4-24
Cautions for using smart key	4-24
Using emergency key (smart key)*	4-25
How to Remove Emergency Key	4-25

Door LOCK/UNLOCK With Emergency Key	4-25
Smart key battery low	4-26
Starting Engine With Smart Key Battery Dead	4-26
Replacing smart key battery	4-27
Instrument cluster	4-29
Standard type	4-29
Supervision type*	4-31
Driving information display window	4-33
Engine RPM	4-33
Driving speed	4-33
Over speed warning light (GCC only)	4-33
Engine coolant temperature	4-33
Fuel gauge	4-34
Total mileage	4-34
Position of gear shift lever	4-35
Automatic Transmission	4-35
Gear shift point indicator	4-35
Warning lights and indicators	4-37
Seat belt warning lamp	4-37
Air bag warning lamp*	4-37
Engine oil pressure warning light	4-37
Charge warning light	4-38
Door open warning light	4-38
Engine hood open warning light	4-38
SCR warning lamp*	4-39

Engine overheat warning lamp	4-39	Lane departure indicator/warning light*	4-45	ISG cumulative time	4-53
SSPS warning lamp* (w/o EPS)	4-39	Illumination ON indicator	4-46	TPMS status	4-54
Electric power steering warning light	4-40	Front fog lamp ON indicator*	4-46	Urea level	4-54
Water separator warning light (DSL only)	4-40	Rear fog lamp ON indicator*	4-46	Digital speedometer	4-54
Brake warning light	4-41	SHB indicator*	4-46	Driving assist	4-55
ABS (Anti-Lock Brake System)* warning light	4-41	High beam indicator	4-47	Driver attention alert	4-55
Electronic Brake-Force Distribution (EBD)* warning light	4-41	Turn signal/hazard warning lamp	4-47	AV screen	4-55
Engine check indicator	4-42	Immobilizer/smart key warning light	4-47	User settings	4-57
4WD CHECK warning indicator*	4-42	WINTER / SPORT indicator lamp (W/EPS)	4-48	Dashboard Lighting	4-57
4WD LOW indicator*	4-42	Winter mode indicator* (W/O EPS)	4-48	Dashboard Settings	4-59
4WD HIGH indicator*	4-42	Power mode indicator* (W/O EPS)	4-48	Display settings	4-60
Steering wheel heater indicator*	4-42	ECO indicator (W/O EPS)	4-48	Vehicle settings	4-61
Electronic stability control system (ESP)* ON indicator/warning light	4-43	ISG indicator/warning lamp	4-49	Message/pop-up message on the display of the instrument cluster	4-62
Electronic stability control system (ESP)* OFF indicator	4-43	ISG OFF indicator	4-49	Message on the display of the instrument cluster	4-62
Low fuel level warning light	4-43	Over speed warning light (GCC only)	4-49	Shift lever in manual transmission 4-107	
Glow indicator (DSL only)	4-44	Master symbol (Supervision type)	4-49	Downshifting	4-108
Global warning light*	4-44	Main menu	4-50	Gear position when parking	4-108
Autonomous Emergency Braking (AEB) warning light*	4-44	Main menu list	4-51	Using the clutch	4-108
Autonomous Emergency Braking (AEB) OFF indicator*	4-45	Trip computer information	4-51	Driving tips for normal starting off or starting off on uphill	4-108
Hill Descent Control (HDC) ON indicator/warning light*	4-45	Distance to empty/average fuel economy/Instantaneous fuel economy	4-51	Parking Brake Operation When Driving Uphill	4-109
		Mileage/average speed/driving time	4-52	Gear selector lever in automatic transmission*	4-110
		Driving information after departure	4-53	P (parking) position	4-111
				R (reverse) position	4-111

N (neutral) position	4-111	Switching between 2H and 4H ⇔ 4L mode	4-120	Cruise control switch and indicator	4-129
D (driving) position	4-112	Vehicle driving modes & indicators	4-121	Cruise control switch	4-129
M (manual) position	4-113	2WD (2H) mode	4-121	Cruise Control Ready / Enabled Display	4-130
Shifting	4-113	4WD HIGH (4H) mode	4-121	Auto cruise READY	4-130
Display of gear shift lever position on the instrument cluster	4-114	4WD LOW (4L) mode	4-122	Auto cruise ENABLED	4-130
Using the engine brake	4-114	4WD CHECK warning indicator	4-122	Setting the cruise control driving speed	4-131
If the gear shift lever cannot be moved from the P (parking) position to another position	4-115	Cautions for using the 4WD system ...	4-123	Speed acceleration process of the cruise control	4-132
Driving a vehicle equipped with automatic transmission	4-116	*LD (Locking Differential)	4-124	Speed deceleration of the cruise control	4-133
Using the engine brake	4-117	Features	4-124	Deactivating the cruise control	4-133
Using the kick down function	4-118	Driving mode	4-125	Deactivation condition	4-133
Safety mode of the automatic transmission	4-118	Drive mode (with EPS)	4-125	Other deactivation conditions according to the vehicle condition ...	4-133
Resetting the safety mode when the gear shift lever is fixed to a position	4-118	Drive mode (without EPS)	4-125	Resuming the cruise control	4-134
Resetting the safety mode	4-118	ISG (Idle Stop & Go) System*	4-126	Intelligent / Adaptive Cruise Control*	4-135
If the fixed gear shift lever phenomenon appears after resetting the safety mode	4-118	Engine automatic shutdown	4-126	Intelligent Cruise Control Ready / Enabled Display	4-135
Cautions for using a vehicle equipped with automatic transmission	4-119	Automatic Engine Restart	4-126	Intelligent Cruise Control Ready	4-135
4WD System*	4-120	ISG system OFF	4-127	Set intelligent cruise (enabled)	4-135
Switching to 4WD	4-120	Conditions for ISG system activation	4-127	To enable intelligent cruise control at instrument cluster	4-136
Switching between 2H ⇔ 4H mode	4-120	Forced restart conditions	4-127	To set intelligent cruise control	4-136
		Battery sensor (BSC)	4-128	Increasing speed	4-137
		Conditions for activating battery sensor (BSC)	4-128	Decreasing speed	4-137
		Cruise control system*	4-129		
		Conditions for using the cruise control	4-129		

Temporary acceleration (override)	4-137	ABS (Anti-Lock Brake System)*	4-150	Autonomous Emergency Braking	
Deactivating	4-138	ABS warning light.....	4-151	(AEB)*.....	4-160
Disable conditions	4-138	Electronic Brake-Force Distribution		AEB indicator/warning light.....	4-160
Other disable conditions	4-138	(EBD)	4-151	AEB OFF indicator	4-160
Resume.....	4-139	EBD warning light*	4-152	AEB indicator/warning light	4-161
To Deactivate.....	4-139	Emergency Stop Signal (ESS)*	4-152	AEB is activated	4-161
Steering wheel (steering force) control		Activation and deactivation		Setting the sensitivity of the forward	
alert	4-140	conditions	4-152	collision warning	4-162
To set safety distance to front		Electronic stability control system		AEBS operation	4-162
vehicle.....	4-142	(ESP)*	4-153	Activation conditions	4-163
Forward situation awareness	4-143	ESP indicator/warning light	4-153	Deactivation conditions	4-163
Starting at congested areas	4-143	ESP OFF indicator	4-153	The AEB cannot detect a vehicle	
Front detection sensor		Phenomenon that occurs when the		properly:	4-164
(Front radar + front camera)	4-143	ESP is activated.....	4-154	The AEB cannot detect a	
Vehicle detection is difficult under the		When it is necessary to deactivate the		pedestrian	4-166
following circumstances:.....	4-144	ESP function	4-154	Rear and side warning system*	4-168
Not detected preceding pedestrian ..	4-145	Hill Descent Control (HDC)*	4-155	Display of rear and side warning	
Curved road	4-145	Activating/deactivating the HDC		system activation	4-168
Uphill or downhill.....	4-146	function	4-155	Activating/deactivating the warning	
To change lane	4-146	HDC indicator/warning light.....	4-156	buzzer of the rear and side warning	
Detecting vehicle ahead	4-147	HDC activation conditions.....	4-156	system	4-169
Brake system	4-148	HDC deactivation conditions	4-156	Warning level of the rear and side	
Foot brake.....	4-149	HDC operation	4-156	warning system	4-169
Checking for foreign materials on the		Manual parking brake.....	4-157	When the rear and side warning	
pedal operation area.....	4-149	To operate manual parking brake ...	4-157	system is abnormal	4-170
Checking and replacing the brake		To release manual parking brake ...	4-157	Blind Spot Warning (BSW) system ...	4-170
pads/discs	4-150	Brake warning light.....	4-157	Activation conditions	4-170
If the brake is not working	4-150	Double parking.....	4-159	Lane Change Warning (LCW)	
				system	4-171

Operating conditions.....	4-171
BSA System	4-171
Operating conditions.....	4-171
BSA is deactivated when:	4-172
RCTW System	4-172
Activating / deactivating RCTW system	4-172
Activation conditions	4-172
RCTA System	4-173
Activating / deactivating RCTA system	4-173
Operating conditions:	4-173
Cases where RCTA system not work	4-174
Cases where the RCTA system malfunctions.....	4-174
SEW System	4-175
Activating / deactivating SEW system	4-176
Operating conditions:	4-176
LDW (Lane Departure Warning)*.....	4-177
To activate / deactivate lane departure warning (LDW)	4-177
Activating/deactivating the LDW	4-177
LDW ON indicator	4-178
Activation conditions	4-178
Message on instrument cluster	4-179
Both lane lines are detected.....	4-179

Only one lane line is detected.....	4-179
Driving at low speed or both lane lines are not detected.....	4-179
Approaching a lane line without a turn signal	4-179
LDW cannot operate.....	4-180
System check in progress.....	4-180
System OFF	4-180
Cases that the system is not activated	4-180
Cases requiring the driver's attention.....	4-181
Lane Keeping Assistance (LKA)* ...	4-183
To activate / deactivate lane keeping assistance (LKA).....	4-183
To enable / disable LKA	4-184
LKA ON indicator.....	4-184
Operating conditions	4-184
Message on instrument cluster	4-185
Both lane lines are detected.....	4-185
Only one lane line is detected.....	4-185
Driving at low speed or both lane lines are not detected.....	4-186
Approaching a lane line without a turn signal	4-186
LKA cannot operate.....	4-186
System check in progress.....	4-186
System OFF	4-186

Cases that the system is not activated	4-187
Cases requiring the driver's attention.....	4-187
ELK (Emergency Lane Keeping)* ..	4-189
RKA-ROADEDGE (Lane Keeping Assist-Roadedge).....	4-189
Activation / Deactivation.....	4-189
TSR (Traffic signal recognition)*	4-192
Setting	4-192
FVSW (Front Vehicle Start Warning)*	4-193
Parking assist system*	4-194
Front/rear obstacle detection system	4-194
Activating the obstacle detection system	4-195
Indication on the display of the instrument cluster	4-195
Warning buzzer interval	4-196
Sensor and relevant system malfunction	4-197
If the system does not operate or malfunctions.....	4-197
Cautions regarding the front/rear obstacle detection system.....	4-198
Rear camera system.....	4-199

Around View Monitoring (AVM) system	4-200
Activation conditions	4-201
AVM settings	4-201
Front AVM operation	4-201
Rear AVM operation	4-202

5. Emergency Measures in the Event of Emergency

Warning triangle and OVM (Owner Vehicle Maintenance) tools 5-2

Warning triangle*	5-2
Storage place of the warning triangle	5-2
OVM tools	5-2
Location where the OVM tools are stored	5-3

When the engine cannot be started due to depletion of the battery..... 5-4

Starting the engine using the jump cable	5-4
--	-----

When the engine is overheated or other problems have occurred 5-6

When the engine is overheated so that the warning light turns on	5-6
Symptoms that appear when the engine is overheated	5-6

Emergency measures when the engine is overheated	5-6
Accident or fire	5-7
Accident	5-7
Fire	5-7
When the engine check indicator turns on	5-8
When the water separator warning light turns on (diesel-powered vehicle)	5-8

When a tire is flat 5-9

Repairing a flat tire/inflating a tire using the service kit for tire repair	5-10
Components of the service kit for tire repair (Type A)	5-10
Storage location of the service kit	5-10
Confirming whether it is possible to repair the flat tire with the service kit or not	5-10
Operating principle of the service kit	5-11
Repairing a flat tire	5-11
Checking the tire treasure after repairing a flat tire	5-15
Inflating a tire	5-15
Components of the service kit for tire repair (Type B)	5-17
Repairing a flat tire	5-17
Checking the tire treasure after repairing a flat tire	5-21

Inflating a tire	5-22
Removing the spare tire	5-23
Changing a spare tire	5-24
When replacing a front tire	5-24
When replacing a rear tire	5-25
Cautions when changing the tire	5-27

When you need to have your vehicle towed..... 5-28

Towing a disabled vehicle	5-28
Towing with tow truck	5-28
For 4WD vehicle	5-28
For 2WD vehicles	5-28
When a tow truck is unavailable (in case of emergency)	5-29
Installing the towing hook	5-29
Using a towing rope	5-30
Trailer towing	5-31
Trailer loading	5-31
Maximum Load Limits	5-31
If you want to pull a trailer	5-33
Weight of trailer	5-33
Weight of trailer tongue	5-33
Trailer brakes	5-34
Trailer lights	5-34
Tires	5-34
Safety chains	5-34
Brake fluid	5-34
Automatic transmission fluid	5-34

Towing tips.....	5-34
Driving on hill.....	5-35
Parking on hills	5-35
When you are ready to leave after parking on a hill	5-35
Maintenance when towing trailer.....	5-35

When the vehicle has stopped due to a failure..... 5-36

In the event of an accident..... 5-37

Tips when an accident or a malfunction occurs on the expressway.....	5-37
--	------

In the event of a fire..... 5-38

Placing an extinguisher in the vehicle	5-38
How to use the extinguisher*	5-38
Checking and maintaining the extinguisher	5-39

In the event of a heavy snow..... 5-40

6. Periodic Checking and Maintenance

Scheduled maintenance services (EU) - D22DTR 6-2

Scheduled maintenance services (GEN) - D22DTR 6-5

Scheduled maintenance services (under severe condition) - D22DTR ... 6-8

Scheduled maintenance services - G20DTR6-11

Scheduled maintenance services (under severe condition) - G20DTR · 6-14

Checking the engine room..... 6-17

Diesel Engine (D22DTR)	6-17
Gasoline engine (G20DTR)	6-18

Engine oil..... 6-19

Level Check	6-19
Replenishment	6-19
Function of engine oil	6-20
Consumption of Engine Oil	6-20
Engine care.....	6-20
Change interval.....	6-21
Specification and capacity	6-21

Warnings and cautions when checking	6-21
Engine	6-22
SAE viscosity classes.....	6-22

Engine coolant 6-23

Level Check	6-23
Service Interval.....	6-23
Replenishment	6-24

Air cleaner..... 6-25

Cleaning.....	6-25
Change	6-26

Fuel filter (D22DTR)..... 6-27

Priming Pump Operating Conditions	6-27
Water Separating Function	6-27
Operating the priming pump	6-27
Operating conditions.....	6-27
Operating method	6-28

Brake and clutch fluid (with M/T) 6-29

Specification and Replacement	6-29
Level Check and Replenishment	6-29

Washer fluid 6-30

Top up washer fluid.....	6-30
--------------------------	------

Power steering fluid 6-31

Specification and Capacity.....	6-31
---------------------------------	------

Battery 6-32

Battery Maintenance.....	6-32
Specification	6-32

Spark plugs - Gasoline engine 6-34

Checking the wipers and replacing the blade 6-35

Replacing the blade of windshield wiper.....	6-35
Specifications of wiper blade	6-35

Checking and replacing fuses and relays..... 6-36

- Engine compartment fuse and relay box..... 6-36
- Interior fuse box 6-36
- Checking and replacing fuses 6-37

Checking and replacing the lamps..... 6-38

- Specifications of lamps and checking ... 6-38
 - Specifications and quantity of lamps and bulbs 6-38
 - Checking the lamps 6-39
- Position of exterior lights and lamps 6-40
 - Characteristics of a HID head lamp 6-42
- Replacing exterior lamps 6-43
 - Replacing the rear turn signal lamps..... 6-43
- Position of interior lamps 6-45
- Replacing the interior lamps 6-46
 - Center Room Lamp 6-46
 - Door Courtesy Lamp 6-46
 - Sun Visor Lamp 6-47
 - Glove Box Lamp 6-47

Replacing the A/C filter 6-48

Checking the tires and wheels 6-50

- Checking the tire pressure 6-50
- Prescribed tire inflation pressure 6-50

Wheel alignment status and the balance between tires and wheels..... 6-50

- Tire sizing chart 6-51
- Checking the status of tire wear 6-52
- Rotating the tire positions 6-52
- Snow tire 6-52
- Tire chain 6-53
- Cautions for checking the tires and wheels..... 6-53

Vehicle management during winter 6-55

- Starting the engine and driving the vehicle..... 6-55
- Managing the engine oil..... 6-55
- Managing the engine coolant..... 6-55
- Managing washer fluid 6-55
- Installing a snow tire..... 6-55
- Managing the A/C..... 6-56
- Management of a diesel-powered vehicle..... 6-56
- Other maintenance 6-56
- Cautions for parking during winter 6-57

Cautions for using biodiesel fuel 6-58

Cautions for driving a vehicle equipped with the turbo charger 6-59

Warnings for self-maintenance..... 6-60

Regulation of exhaust gas and relevant systems 6-61

- Particulate reduction management for diesel-powered vehicle 6-61
- Emission reduction device..... 6-62
 - Diesel Oxidation Catalyst (DOC) - EU4..... 6-62
 - LNT (Lean & NOx Trap) DPF (Diesel Particulate Filter) - EU6 6-62
 - Regeneration Process 6-62
 - When the Engine CHECK Indicator Flashes 6-62

Exhaust gas after-treatment system II (SCR)* 6-63

- Warning due to low urea solution level..... 6-63
- Warning due to faulty urea solution system, low urea solution and catalyst efficiency 6-64
- Filling urea solution..... 6-68
- Restriction of restarting due to low urea solution level 6-69
- How to disable restart protection 6-69
- Storing urea solution..... 6-69
- Cautions for the exhaust gas after-treatment system (SCR) 6-70

7. Index

Table of Pictures

Find the desired information using a picture easily even if you do not know the title of the desired information.

Front section

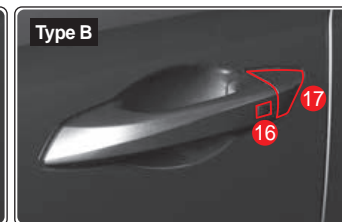
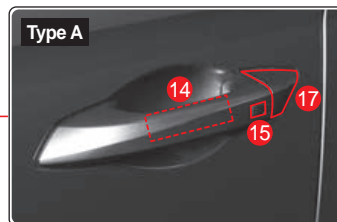
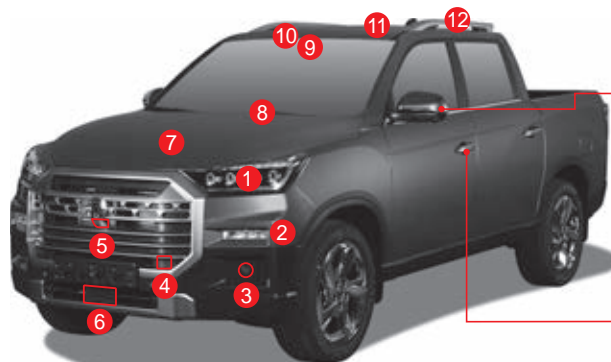

- | | | |
|--|--|--|
| <p>1 Head light (head light) 3-33, 6-38, 6-40</p> <ul style="list-style-type: none"> • Smart High Beam (SHB) 3-37 • Daytime running light (DRL) 3-36 <p>2 Front fog light & Cornering lamp
..... 3-33, 6-40</p> <p>3 Front obstacle detection sensor 4-194</p> <p>4 Front towing hook 5-29</p> <p>5 Front parking assist system 4-194</p> <ul style="list-style-type: none"> • Around view monitoring (AVM)
system 4-200 | <p>6 Front detection sensor (front radar) 4-143</p> <p>7 Engine hood 3-28</p> <p>8 Windshield wiper 3-46, 6-35</p> <p>9 Front camera module (FCM)
..... 4-160, 4-177</p> <ul style="list-style-type: none"> • Autonomous Emergency Braking
(AEB) 4-160 • Lane Departure Warning (LDW) 4-177 • Lane Keeping Assist (LKA) 4-183 • Front Vehicle Start Warning
(FVSW) 4-193 | <p>10 Auto light/rain sensor 3-40/3-47</p> <p>11 Sunroof 3-20</p> <p>12 Roof rack 3-79</p> <p>13 Puddle lamp 3-39</p> <p>14 Door handle touch sensor (unlock) 4-21</p> <p>15 Door handle touch sensor (lock) 4-20</p> <p>16 Door handle switch (unlock/lock) 4-23</p> <p>17 Using emergency key 4-25</p> |
|--|--|--|

Rear section

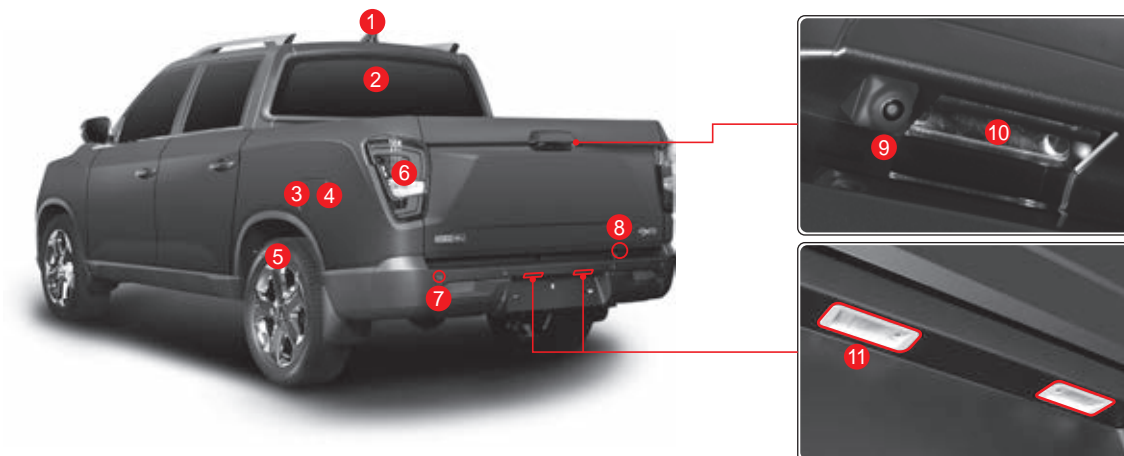

- | | | |
|---------------------------------------|---|--|
| 1 Antenna3-70 | 5 Tire and wheel6-50 | 9 Rear camera 4-200 |
| 2 Rear window heater 3-56, 3-64 | 6 Rear lamp 3-31, 6-40, 6-43 | • Rear view camera 4-199 |
| 3 Fuel inlet3-29 | 7 Rear obstacle detection sensor4-194 | • Around view monitoring (AVM) system..... 4-200 |
| 4 Urea solution inlet.....6-68 | 8 Rear towing hook5-29 | 10 Tailgate (Loading goods and deck)....3-24 |
| | | 11 License plate lamp3-31 |

Driver seat door section

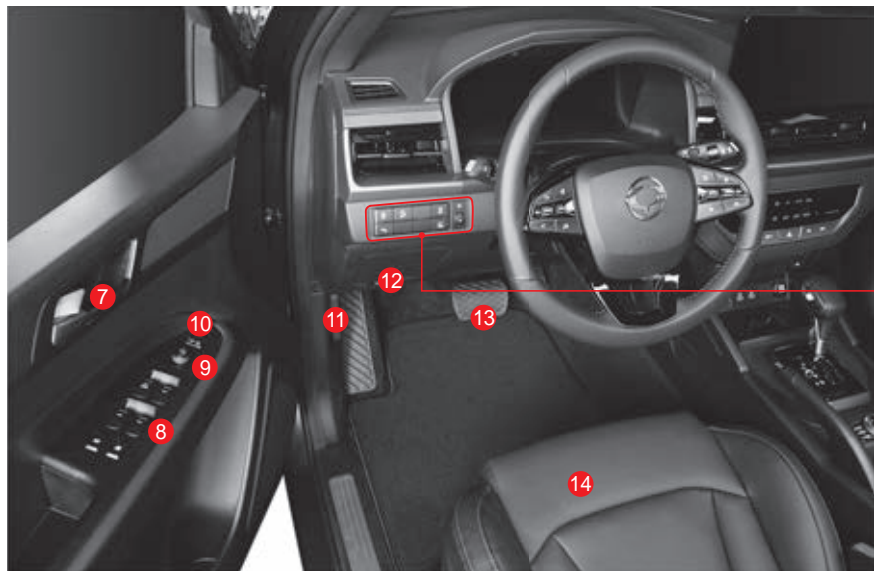

- | | | |
|--|--|---|
| <p>① Electronic stability control system (ESP) OFF switch.....4-153</p> <p>② Hill descent control (HDC) switch....4-155</p> <p>③ ISG OFF switch4-126</p> <p>④ Front obstacle detection warning ON/OFF switch4-194</p> <p>⑤ Around view operation switch4-200</p> | <p>⑥ Headlight leveling switch.....3-35</p> <p>⑦ Door lever..... 3-2</p> <p>⑧ Opening/closing windows.....3-17</p> <p>⑨ Outside rearview mirror control switch3-48</p> <p>⑩ Outside rearview mirror folding/unfolding switch3-48</p> | <p>⑪ Engine hood opening lever3-28</p> <p>⑫ Interior fuse box.....6-36</p> <p>⑬ Foot brake..... 4-149</p> <ul style="list-style-type: none"> • Electronic brake-force distribution (EBD)..... 4-151 • Emergency stop signal (ESS) 4-152 <p>⑭ Front seats..... 3-6</p> |
|--|--|---|

Driver steering wheel section

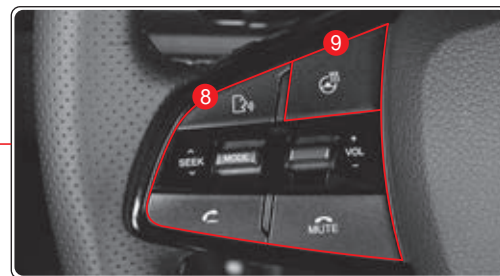

- 1 Instrument cluster.....4-29, 4-31
- 2 Light switch.....3-33
- 3 Driver air bag.....2-20
- 4 Steering wheel telescoping/tilt control lever3-66

- 5 Cruise control switch.....4-129
- 6 Instrument cluster menu and control buttons.....4-50
- 7 LKAS switch4-184
 - Lane departure warning (LDW) 4-177
 - Lane Keeping Assist (LKA)..... 4-183

- 8 Steering wheel multimedia switch3-69
- 9 Steering wheel heater switch3-66

Interior front view



- | | | | | | |
|----------------------------------|------|---------------------------------|------|------------------|------|
| 1 Sun visor..... | 3-74 | 3 Inside rear view mirror | 3-49 | 5 Glove box..... | 3-77 |
| 2 Overhead console assembly..... | 3-43 | 4 Ignition switch | 4-9 | | |
| • Sunroof control switch | 3-20 | | | | |
| • Front room lamp..... | 3-43 | | | | |

Central console section

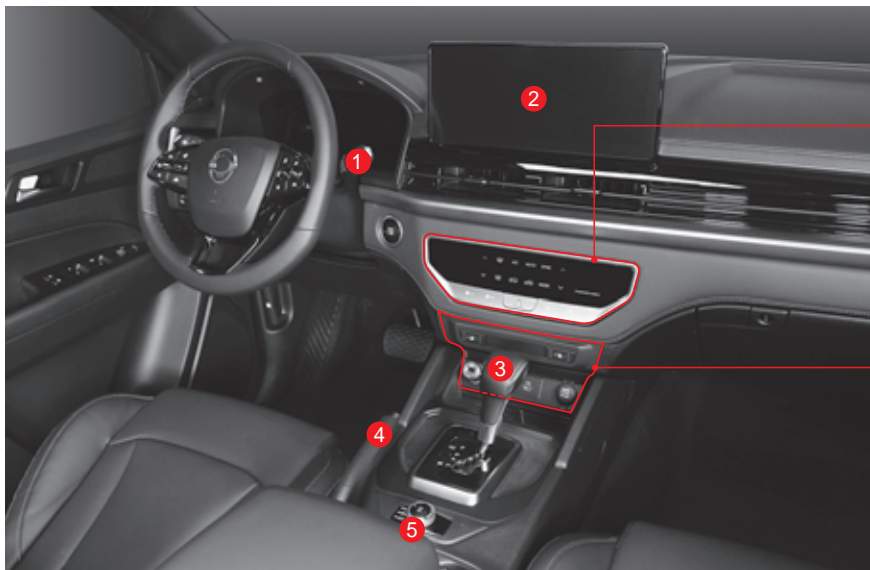

- | | | |
|------------------------------------|--|---------------------------------|
| 1 Wiper and washer lever3-46 | 6 Hazard warning lamp switch3-34 | 10 Cigarette lighter3-72 |
| 2 AVN, Smart, MP3 audio3-67 | 7 Glass heater switch3-56, 3-64 | 11 Multimedia terminal.....3-68 |
| 3 TGS lever4-107 | 8 Heater and A/C controller
(A/C filter)3-51, 6-48
• A/C filter replacement.....6-48 | 12 USB charging port3-73 |
| 4 Manual parking brake4-157 | 9 Front seat heating/ventilation button..3-13 | 13 Front power socket3-71 |
| 5 4WD selection switch4-120 | | |

Rear seats



- ① Rear seats 3-11
- ② Rear cup holder and armrest 3-76
- ③ Rear seat belt 2-5
- ④ Child restraint system 2-10
- ⑤ Door lever 3-2
- ⑥ Rear seat heater switch 3-15
- ⑦ Rear door window switch 3-18

Luggage compartment



- ⑧ Cargo lashing deck tie ring 3-25

Engine room

Diesel engine

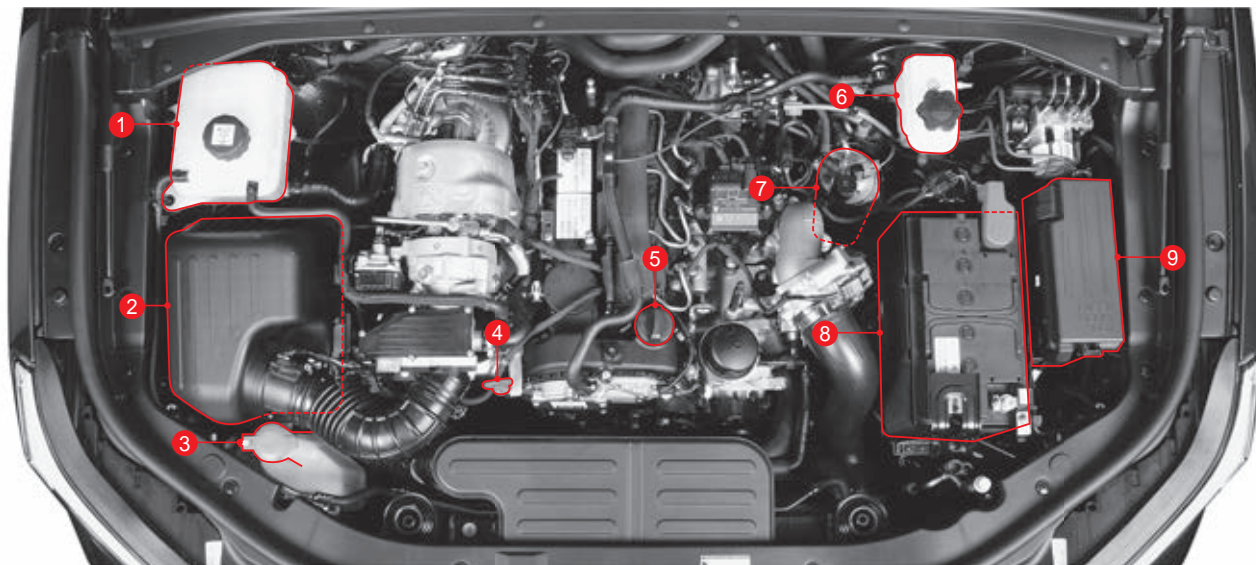

1	Checking coolant.....	6-23	6	Checking brake fluid	6-29
2	Air cleaner	6-25	7	Fuel filter	6-27
3	Checking and adding washer fluid	6-30	8	Managing battery	6-32
4	Checking engine oil	6-19	9	Fuse and relay.....	6-36
5	Adding engine oil	6-19			

Gasoline engine

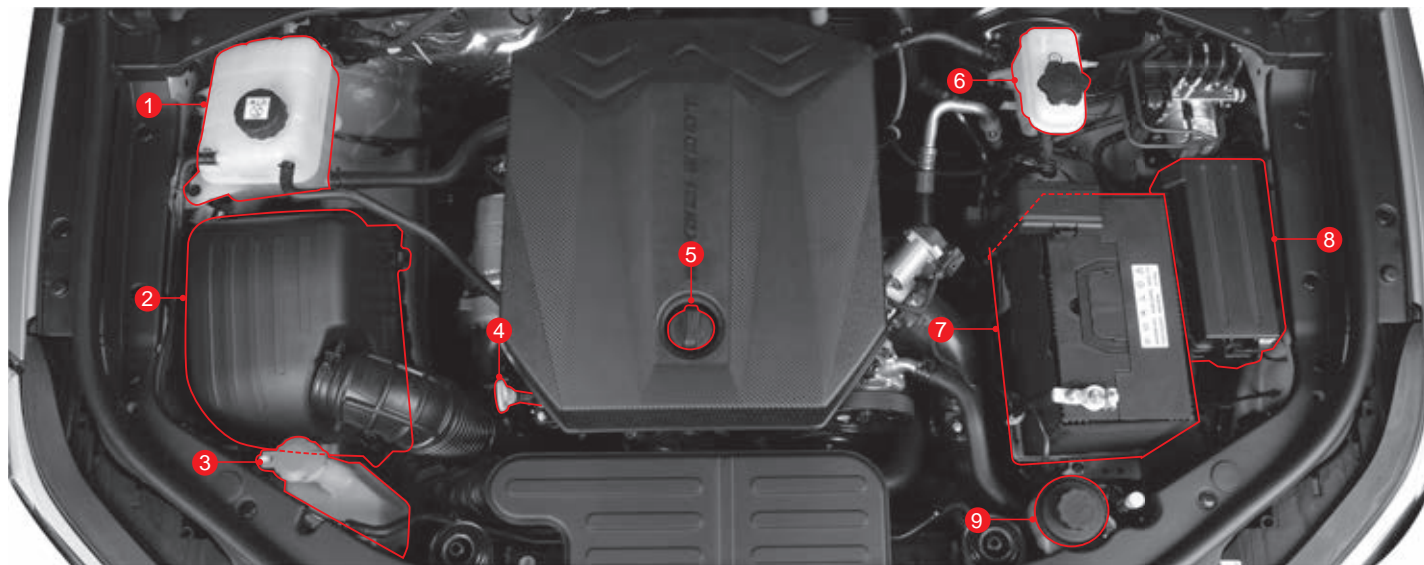

1	Checking coolant.....	6-23
2	Air cleaner	6-25
3	Checking and adding washer fluid	6-30
4	Checking engine oil	6-19
5	Adding engine oil	6-19

6	Checking brake fluid	6-29
7	Managing battery	6-32
8	Fuse and relay.....	6-36
9	Power steering oil.....	6-31

Warning lights and indicators





Image	Meaning/Relevant page
	Seat belt warning lamp 2-2, 4-37
	Air bag warning lamp 2-18, 4-37
	Global warning light 2-27, 4-44
	Immobilizer/Smart key warning light..... 2-32, 4-47
	Engine oil pressure warning light 4-37
	Charge warning light 4-38
	Door open warning light 4-38
	Engine hood open indicator 4-38









Image	Meaning/Relevant page
	SCR warning lamp..... 4-39
	Engine overheat warning lamp 4-39
	SSPS warning lamp..... 4-39
	Electric power steering warning light..... 4-40
	Water separator warning light 4-40, 5-8
BRAKE 	Brake warning light 4-41, 4-158
	ABS (Anti-Lock Brake System) warning light..... 4-41, 4-151
	Engine check indicator 4-42, 5-8
4WD CHECK	4WD CHECK warning indicator 4-42, 4-122







Image	Meaning/Relevant page
4WD LOW	4WD LOW indicator 4-42, 4-122
4WD HIGH	4WD HIGH indicator 4-42, 4-121
	Steering wheel heater indicator 4-42
	Electronic stability control system (ESP) ON indicator/ warning light..... 4-43, 4-153
	ESP OFF indicator 4-43, 4-153
	Low fuel level warning light 4-43
	Glow indicator..... 4-44
	Autonomous Emergency Braking System (AEBS) warning light..... 4-44, 4-160







Image	Meaning/Relevant page
AEBS OFF	AEBS OFF indicator4-45, 4-160
	HDC ON indicator/warning light4-45, 4-156
	Lane departure indicator/ warning light.....4-45, 4-183
	Illumination ON indicator4-46
	Front fog light ON indicator 4-46
	SHB indicator4-46
	High beam indicator4-47
	Turn signal/hazard warning lamp.....4-47







Image	Meaning/Relevant page
WINTER	Winter mode indicator4-48
120 km/h	Over speed (120 km/h) (GCC only)..... 4-33, 4-49
	Rear fog lamp ON indicator 4-46
POWER	Power mode indicator4-48
ECO	ECO
	CHECK stop lamp warning indicator
	Hands OFF warning lamp

Image	Meaning/Relevant page
	ISG indicator/warning light4-49, 4-126
	ISG OFF indicator.. 4-49, 4-127
SPORT	SPORT mode indicator4-48
	Master symbol4-49

1. Vehicle Information and Safety Precautions

You can check helpful information for driving and managing the vehicle safely and conveniently.

Information regarding the vehicle identification, specifications, check points before driving the vehicle, safety precautions while driving, and vehicle maintenance methods is provided.

Information regarding the installation of ADR and provision of information

Installation of ADR (Accident Data Recorder) and provision of information

This vehicle has an ADR (Accident Data Recorder).

The ADR (Accident Data Recorder) is a device that can record and check the driving information of the vehicle (vehicle speed and operation status of brake pedal and acceleration pedal, etc.) for a certain period of time before and after an accident, such as a car crash.

The ADR (Accident Data Recorder) helps to better understand an accident situation.

Precautions for potentially hazardous seat belt related goods



Warning

When potentially hazardous seat belt related goods are used, the safety of passengers will be seriously endangered. Never use these goods.

1

Do not use the clip to disable the seat belt alarm

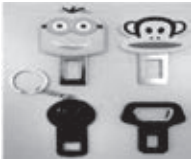

When this clip is inserted into the seat belt buckle, the seat belt is recognized as fastened, so the seat belt warning lamp and alarm are not activated.

This leads to no fastening of the seat belt, and it is very dangerous when an accident occurs.

Do not use the seat belt stopper



When it is installed on the seat belt, it hinders the normal automatic locking function of the retractor and lowers the performance of the seat belt.

Do not use playroom mat



When it is installed in the rear seat, it will lead to not fastening seat belts and car seats, and it is very dangerous when an accident occurs.

Precautions for the reduction of non-crash incidents



Warning

A part of your body may get stuck or hit and get seriously injured when opening and closing the doors. Caution should be taken.



- When you open and close the doors, a part of your body such as your finger or head may get stuck or hit and get seriously injured. Open and close the doors after ensuring that no part of your body is stuck or hit.



- When you open or close the trunk (tail gate), a part of your body such as your finger or head may get stuck or hit and get injured. Open or close the trunk after ensuring safety.
- The trunk (tail gate) is raised or lowered automatically at below or over a certain level. Always take caution to avoid your face or head from getting hit or your hand from getting stuck.



- Close the windows after checking that other passengers' hands or heads are away from the windows. This is especially important for children, who may get a serious injury, such as suffocation if their head gets stuck.
- When you pull the switch continuously to raise the window at a position where something is pinched first without operating the one touch auto close function, the anti-pinch function will not operate.
- Especially when a part of a child's body is on the window, a certain amount of force (resistance) is not applied to the window, so the anti-pinch function may not operate. Make sure to check before closing the windows.

Cautions for the protection of the environment

KG Mobility Corporation environment-related policies aim at comprehensive protection of the environment. This is also a way to save natural resources that become the basis of human survival on earth, and meet and harmonize the demands of nature and mankind.

You can contribute to the protection of the environment by operating our vehicle in an eco-friendly way.

Fuel consumption, engine speed, transmission control and wear of brakes and tires are influenced by driving conditions and habits.

Observe the following content and participate in the protection of the environment.

Driving conditions

- Avoid short trips since it increases fuel consumption relatively.
- Always check if the tire inflation pressure is appropriate.
- Unload unnecessary goods from the luggage compartment.
- Always check the fuel efficiency.
- Have your vehicle checked periodically.

Driving habits



- Do not depress the accelerator pedal when starting the engine.
- Drive off in the vehicle slowly.
- Keep a safe distance with the vehicle ahead and drive carefully.
- Avoid frequent acceleration or deceleration.
- Avoid sudden acceleration, deceleration, or stops.
- In manual mode, shift the gears properly and avoid exceeding 2/3 of the maximum engine RPM in each gear.
- Avoid warming up the vehicle while stopping.
- Turn off the engine when you stop the vehicle for a long time.

Recycling

- Information about eco-friendly product development and vehicle recycling can be found on the KG Mobility Corporation website www.kg-mobility.com/en

Certification

1. TIRE PRESSURE MONITORING SYSTEM

CE	<p>Hereby, KG Mobility, declares that the in-vehicle mounted radio systems are in compliance with the essential requirements and other relevant provisions of Directive 1999/5/EC</p>	EU
FCC	<p>Model: TSSSG4G5 and TSSRE4Db FCC ID: OYGTSSRE4DB ORD. No: 14778/DFRS19614/F-50 This device complies with Part 15 of the Federal Communications Commission (FCC) rules. Operation is subject to the following two conditions: (1) this device may not cause harmful interference, and (2) this device must accept any interference received, including interference that may cause undesired operation.</p> <div style="border: 1px solid black; background-color: #f4a460; padding: 5px; text-align: center;">  Warning </div> <ul style="list-style-type: none"> • Changes or modifications not expressly approved by the party responsible for compliance could void the user's authority to operate the equipment. 	AMERICA
CU TR	<p>LOGO</p>  <p>Certificate in the user manual due to product size Tire Pressure Monitoring System Model: TSSRE4Db The device passed all the conformity assesment procedures to CU TR.</p>  EAC mark in the user manual due to product size.	CIS



2. FOB/FOLDING

<p>FCC</p>	<p>FCC ID: DEO-MT-FLIP01</p> <p>This device complies with Part 15 of the Federal Communications Commission (FCC) rules.</p> <p>Operation is subject to the following two conditions:</p> <ol style="list-style-type: none"> (1) this device may not cause harmful interference, and (2) this device must accept any interference received, including interference that may cause undesired operation. <div style="border: 1px solid black; background-color: #f9cb9c; padding: 5px; text-align: center;"> <p>Warning</p> </div> <ul style="list-style-type: none"> • Changes or modifications not expressly approved by the party responsible for compliance could void the user's authority to operate the equipment. 	<p>AMERICA</p>
<p>TR</p>	<p>LOGO</p>  <p>Certificate in the user manual due to product size</p>	<p>CIS</p>

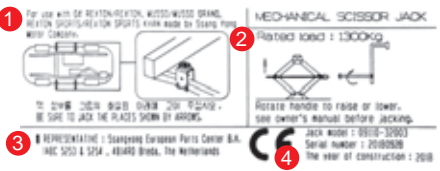
3. JACK LABEL

<p>CE</p>	 <p>1 Model name</p> <p>2 Maximum allowable load</p> <p>3 Representative company and address</p> <p>4 Production date</p> <div style="border: 1px solid black; background-color: #f9cb9c; padding: 5px; text-align: center;"> <p>Caution</p> </div> <ul style="list-style-type: none"> • When using the jack, set your parking brake. • When using the jack, stop the engine. • Do not get under a vehicle that is supported by a jack. • The designated locations under the frame • When supporting the vehicle, the base plate of jack must be vertical under the lifting point. • Shift into Reverse gear on vehicles with manual transmission or move the shift lever to the P (Park) position on vehicles with automatic transmission. • The jack should be used on firm level ground. 	<p>EU</p>
-----------	---	-----------

4. Compressor, Jack

CE	LOGO  (1) Description Model: CE certified parts (2) Representative: KG Mobility European Parts Center B.V. (3) Address: IABC 5253&5254, 4814RD Breda, The Netherlands	EU
UKCA	LOGO  (1) Description Model: UKCA certified parts (2) Importer: KG Mobility UK Ltd (3) Address: G Offices, Parsonage Road, Stratton St. Margaret, Swindon, Wiltshire SN3 4RN	UK

Vehicle identification

The identification numbers including the vehicle identification number and the engine number are the unique information of the vehicle. If you know this information, it is very convenient for making inquiries about the vehicle or placing an order for a component or accessory.

Certification label

The certification label includes information including the vehicle identification number, tire inflation pressure, vehicle weight, and color necessary for maintaining the vehicle properly.

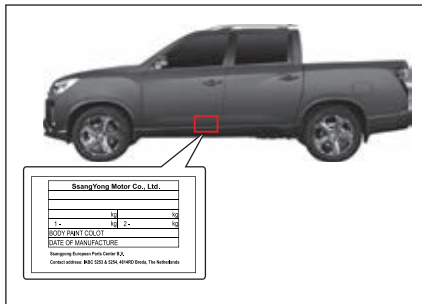

The certification label is attached to the driver's door sill (B pillar).

Vehicle Identification Number (VIN)

The vehicle identification number (VIN) is the identification number that includes vehicle model, manufacturing country and manufacturing year.

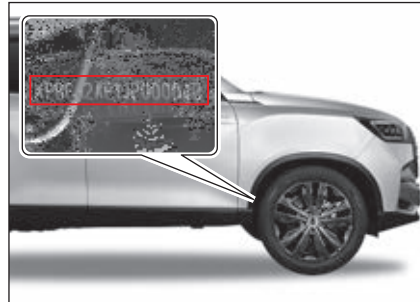

Vin Label



The VIN is stamped on top of the instrument panel.

Engine number

The engine number is the identification number including the type of fuel, engine type and displacement, etc.

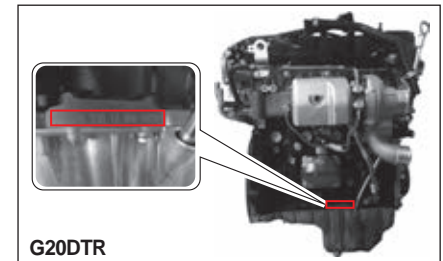

Gasoline Engine: The engine number is stamped on the bottom surface of the cylinder block behind the intake manifold.

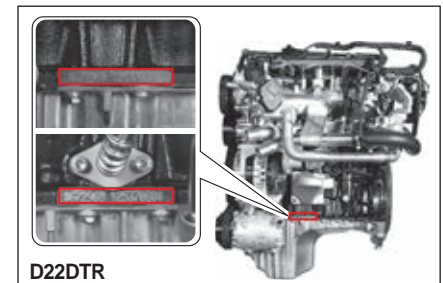

Diesel Engine: The engine number is stamped on the bottom surface of the cylinder block behind the exhaust manifold.

Dimensions (MUSSO Type-A)

Unit: mm

Front

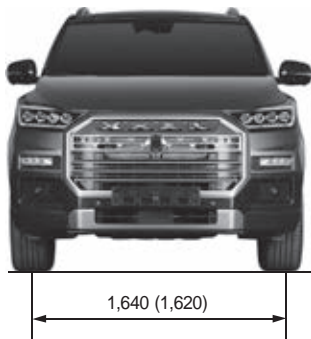

Top

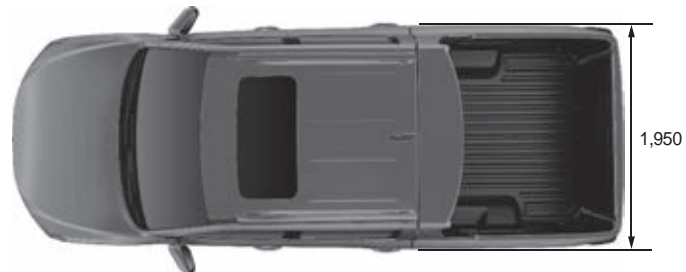

Rear



Side

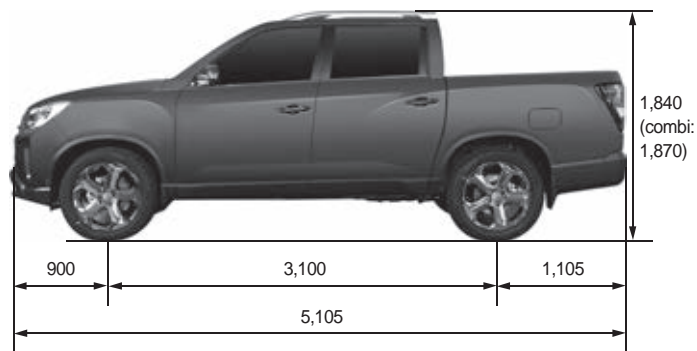

* (): Optional

Dimensions (MUSSO Type-B)

Unit: mm

Front



Top

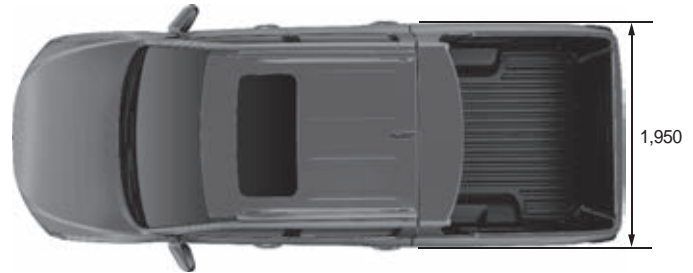

Rear



Side

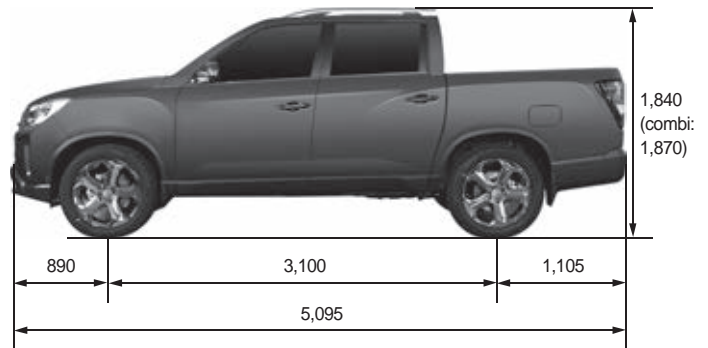

* (): Optional

Dimensions (MUSSO GRAND Type-A)

Unit: mm

Front



Top

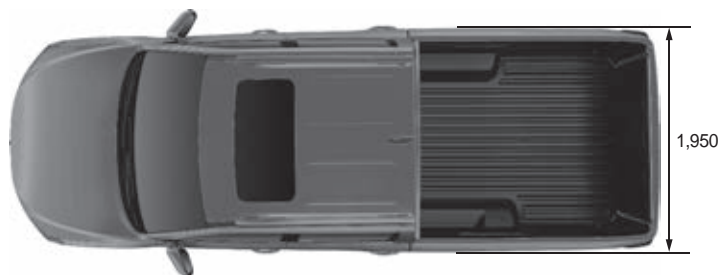

Rear



Side

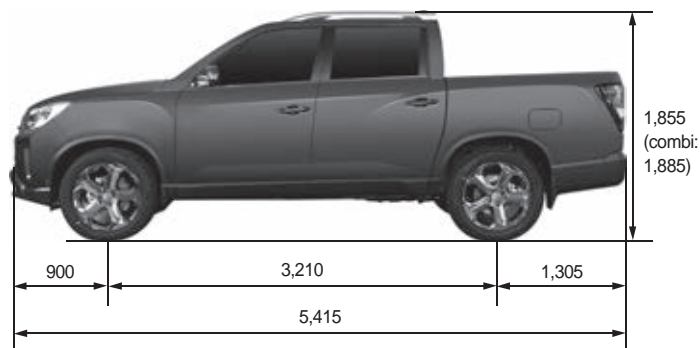

* (): Optional

Dimensions (MUSSO GRAND Type-B)

Unit: mm

Front



Top

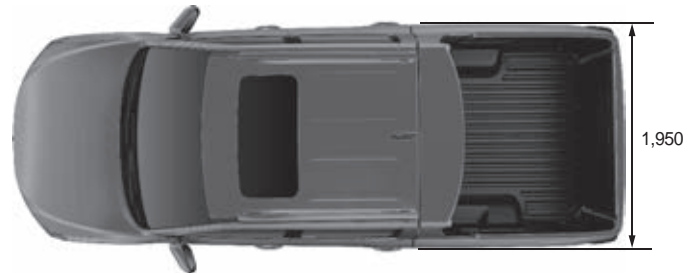

Rear



Side

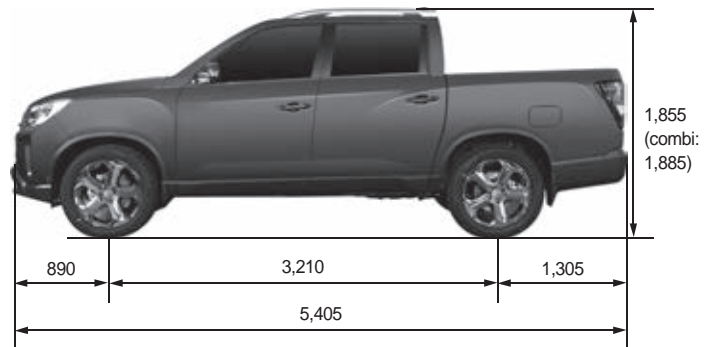

* (): Optional

Specifications (I)

* (): Optional, []: 2WD
D22DTR: Diesel, G20DTR: Gasoline

Descriptions				MUSSO		MUSSO GRAND		
				D22DTR	G20DTR	D22DTR	G20DTR	
General	Overall length (mm)			5,095 (5,105)	←	5,405 (5,415)	←	
	Overall width (mm)			1,950	←	←	←	
	Overall height (mm)			1,840 (combi ANT: 1,870)	←	1,855 (combi ANT: 1,885)	←	
	Gross vehicle weight (kg)	5-Link	EU	2,940 [2,840]	–	2,990 [2,890]	–	
			GEN	2,880 [2,830]	2,860 [2,810]	2,980 [2,880]	2,960 [2,860]	
		Leaf	EU	–	–	3,260 [3,160]	–	
			GEN	–	–	3,220 [3,120]	3,200 [3,100]	
	Curb vehicle weight (kg)	A/T	5-Link	EU	2,165 [2,065]	–	2,205 [2,105]	–
				GEN EU4-6b	2,210 [2,110]	2,184 [2,084]	2,220 [2,115]	2,194 [2,089]
			Leaf	EU	–	–	2,256 [2,156]	–
				GEN EU4-6b	–	–	2,316 [2,211]	2,290 [2,185]
		M/T	5-Link	EU	2,155 [2,055]	–	2,195 [2,095]	–
				GEN EU4-6b	2,196 [2,096]	2,170 [2,070]	2,206 [2,106]	2,180 [2,080]
			Leaf	EU	–	–	2,246 [2,146]	–
GEN EU4-6b				–	–	2,302 [2,197]	2,276 [2,171]	
Fuel			Diesel	Gasoline	Diesel	Gasoline		
Fuel tank capacity (ℓ)			75L	←	←	←		
Minimum turning radius			5.95m	5.95m	6.09m	6.09m		

* () Options, vehicle weights and gross weights are based on the maximum values and they depend on vehicle options and specifications.

Specifications (II)

* (): Optional

Descriptions			MUSSO		MUSSO GRAND		
			D22DTR	G20DTR	D22DTR	G20DTR	
Engine	Numbers of cylinders/Compression ratio		4 / 15.5:1	4 / 9.6:1	4 / 15.5:1	4 / 9.6:1	
	Total displacement (cc)		2,157	1,998	2,157	1,998	
	Camshaft arrangement		DOHC	←	←	←	
	Max. power	EU	148.6 kW / 3,800 rpm (202 ps / 3,800 rpm)	-	148.6 kW / 3,800 rpm (202 ps / 3,800 rpm)	-	
		GEN	133.1 kW / 3,800 rpm (181 ps / 3,800 rpm)	165 kW / 5,500 rpm (225 ps / 5,500 rpm)	133.1 kW / 3,800 rpm (181 ps / 3,800 rpm)	165 kW / 5,500 rpm (225 ps / 5,500 rpm)	
	Max. torque	A/T	EU	441 Nm / 1,600 ~ 2,600 rpm	-	441 Nm / 1,600 ~ 2,600 rpm	-
			GEN	420 Nm / 1,600 ~ 2,600 rpm	350 Nm / 1,500 ~ 4,500 rpm	420 Nm / 1,600 ~ 2,600 rpm	350 Nm / 1,500 ~ 4,500 rpm
		M/T	400 Nm / 1,400 ~ 2,800 rpm	350 Nm / 1,500 ~ 4,500 rpm	400 Nm / 1,400 ~ 2,800 rpm	350 Nm / 1,500 ~ 4,500 rpm	
	Idle speed	EU	720 ± 50 rpm	-	720 ± 50 rpm	-	
		GEN	750 ± 50 rpm	←	←	←	
	Cooling system		Water- cooled / forced circulation	←	←	←	
	Coolant capacity (ℓ)		10.2	11.0	10.2	11.0	
	Lubrication type		Gear pump, forced circulation	←	←	←	
Max. oil capacity (ℓ) (when shipping)		6.0	5.0	6.0	5.0		
Turbocharger and cooling type		Turbocharger, water- cooled	←	←	←		

1

Specifications (III)

* (): Optional

Descriptions			MUSSO		MUSSO GRAND	
			D22DTR	G20DTR	D22DTR	G20DTR
Manual Transmission	Operating type		Floor change type	–	Floor change type	–
	Gear ratio	1st	4.489	←	←	←
		2nd	2.337	←	←	←
		3rd	1.350	←	←	←
		4th	1.000	←	←	←
		5th	0.784	←	←	←
		6th	0.679	←	←	←
Reverse	4.253	←	←	←		
Automatic Transmission	Model		Electronic, 6-speed	←	←	←
	Operating type		Floor change type	←	←	←
	Gear ratio	1st	3.600	←	←	←
		2nd	2.090	←	←	←
		3rd	1.488	←	←	←
		4th	1.000	←	←	←
		5th	0.687	←	←	←
6th		0.580	←	←	←	
Reverse 1st	3.732	←	←	←		
Transfer Case	Model		Part-time	←	←	←
	Type		Planetary gear type	←	←	←
	Gear ratio	High (4H)	1.000 : 1	←	←	←
		Low (4L)	2.483 : 1	←	←	←
Clutch (M/T)	Operating type		Hydraulic type	←	←	←
	Disc type		Dry single diaphragm type	←	←	←

Specifications (IV)

* (): Optional

Descriptions			MUSSO		MUSSO GRAND	
			D22DTR	G20DTR	D22DTR	G20DTR
Power Steering	Type		Rack and pinion	←	←	←
	Steering angle	Inner	39.61°	←	←	←
		Outer	33.65°	←	←	←
Front Axle	Drive shaft type		Ball joint type	←	←	←
	Axle housing type		Build-up type	←	←	←
Rear Axle	Drive shaft type		Semi-floating type	←	←	←
	Axle housing type		Build-up type	←	Build-up type Banjo type	Banjo type
Brake	Master cylinder type		Tandem type	←	←	←
	Booster type		Vacuum assisted booster type	←	←	←
	Brake type	Front wheels	Disc type	←	←	←
		Rear wheels	Disc type	←	←	←
Parking brake		Cable type (internal expansion)	←	←	←	
Suspension	Front suspension		Double - wishbone + coil spring	←	←	←
	Rear suspension		5-link + coil spring	←	5-link + coil spring, Leaf spring	←
Air Conditioner	Refrigerant (capacity)		R-1234yf / 520 ± 30g R-134a / 550 ± 30g	←	←	←
Electrical	Battery type / Capacity (V-AH)		MF / 12 - 90 (AGM 12 - 80)	MF / 12 - 90	MF / 12 - 90 (AGM 12 - 80)	MF / 12 - 90
	Starter capacity (V-KW)		12 - 2.2 (2.0)	12 - 1.4	12 - 2.2 (2.0)	12 - 1.4
	Alternator capacity (V-A)		14 - 140 (GEN), 14 - 160 (EU)	14 - 140 (GEN)	14 - 140 (GEN), 14 - 160 (EU)	14 - 140 (GEN)

1

Precautions for the modification of the vehicle and structural alteration



Warning

Unauthorized vehicle modification, structural alteration and installation of a component may cause car trouble or a fatal accident. Warranty repair will not be provided in case of product malfunction.

- The vehicle you purchased is made of a lot of precision parts passed through a large numbers of researches and tests, and these parts are linked and operate systematically.
- Modifying or changing any part arbitrarily or installing an unauthorized device may cause car trouble and affect the vehicle's performance, durability, and safety. It may lead to a fatal accident.
- Also, warranty repair will not be provided for a modified part as well as a problem that occurred due to the modification, even during the warranty period.

Do not install a separate accessory or auxiliary device to the vehicle operation device arbitrarily.

- Extending the gear shift lever or installing accelerator pedal or brake pedal pads available in the market arbitrarily may cause an operation mistake due to a change in the operating force of the vehicle. In such case, vehicle damage as well as a serious fatal accident may occur.

Do not modify the engine, driving, and exhaust systems.

- Do not adjust the preset value in the fuel supply system, intake, exhaust, and electric systems arbitrarily, or replace with or add a non-standard part in order to increase the engine output or adjust the exhaust sound. Doing so may cause a serious problem with the vehicle's durability. It is illegal.
- In particular, the modification to an LPG vehicle may adversely affect the vehicle's performance and durability. The engine system as well as the transmission and the wheel alignment are excluded from the warranty.

Do not modify the audio system or install additional electronic devices such as wireless communication equipment, rear view camera, TV, and remote starting devices.

- The electrical system of this vehicle consists of electric wires and fuses for installing standard electronic devices.
- Connecting a number of electric wires to the existing wire for installing various additional electronics may cause overloading, resulting in damage to electronic devices and a risk of fire.
- In addition, drilling for installing an antenna may cause the vehicle to rust.

Do not install non-standard tires or wheel-related parts.

- If you install wider or larger tires than the vehicle specifications, the tires and adjacent parts may come into contact with each other and result in wear and damage to the power train system when you operate the steering wheel or drive on an unpaved road.
- In addition, the degradation of driving performance may occur due to an increase in the fuel consumption and braking distance, vibration of the vehicle body, and degraded handling of the steering wheel, and an impact may occur when shifting with the automatic transmission.
- Moreover, it may affect the speedometer and odometer, displaying an incorrect driving speed or a driving distance longer than the actual driving distance.
- If you install a wheel dust cover in order to improve the appearance of the tires, friction heat generated during braking is not released smoothly, causing the fade or vapor lock phenomenon. This may lead to the degradation of braking performance and cause a serious problem.

Do not install a sunroof available in the market or replace with colored glasses arbitrarily.

- If you cut the roof of the vehicle and install a sunroof, rust or water leaks may occur in the cut part.
- Installing colored glasses to improve the appearance and block UV rays after the vehicle is shipped may cause water leaks. Do not install such glasses.

Do not modify the floor inside of the vehicle arbitrarily.

- Do not install an auxiliary article such as floor coverings on the floor inside the vehicle to enhance the cushioning or convenience for cleaning. Doing so may damage the operating device of various electronic systems and electrical wires, and hinder the function of the seat rail that moves the seat forward and backward.
- Also, the locking system to fix the position of the seats may not operate properly. In such case, the seats may move forward or backward, causing an accident, when driving on a downhill road or an uphill road.

Do not replace the seat with a new one with a different function, or install a separate seat cover.

- There are various types of seats according to the function and role even for the same vehicle type and electric wiring has been applied accordingly.
- Do not bring and over-use or modify an adjacent electrical wire in order to replace a seat with a new one with different functions. In such case, it may damage electronic devices and create a risk of fire due to overloading.
- Replacing a seat cover incorrectly may damage electrical devices due to a short circuit or disconnection, or cause poor ventilation, fire and abnormal noise.

Do not install a bumper guide or a guide bar available in the market.

- If you install a bumper guide or a guide bar arbitrarily, problems such as difficulty in parking and stopping due to an increase in the total vehicle length, the waste of fuel due to an increase in the vehicle weight, and the occurrence of rust on the installation holes may occur. In addition, more serious injury may occur in the event of a collision accident due to the absence of a shock absorber in the bumper guide.

Do not attach a functional product that may decrease the driving resistance such as stickers, molding, air dam, or wind proofing products.

- Adhesives of the stickers may damage the coated surface of the vehicle. When drilling is carried out on the vehicle in order to attach molding and other functional parts, the drilled area may rust or abnormal noises may occur while driving.
- Especially if such parts are not attached firmly, such parts may fall off while driving, causing damage to the vehicle as well as a fatal accident.

Checking before driving

Daily inspection



- Check the vehicle once a day before driving.
- Check the engine coolant, engine oil, brake fluid, washer fluid, and belts for abnormality.
- Check for leaks from the battery and the radiator.
- Check the bottom of the vehicle to see if there is an oil or liquid leak.
- Clean the front and rear windshields, rear glasses, side mirrors and room mirror.
- Check the operating status of the various lamps.
- Make sure that there are no obstacles that may hinder the driving around of the vehicle.

Checking engine room

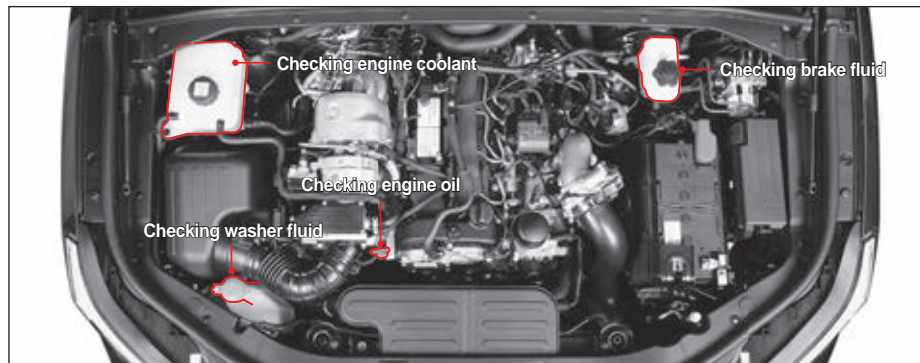

Checking engine coolant



- Check the engine coolant after cooling the engine properly on level ground.
- Check if the coolant level is between the "MAX" mark and the "MIN" mark on the surface of the coolant reservoir. If the level is near or below the "MIN" mark, add coolant.

Checking engine oil



- Check the engine oil after stopping the engine on level ground and waiting for more than 5 minutes.
- Check if the oil level is between the "MAX" mark and the "MIN" mark on the oil level gauge. If the level is near or below the "MIN" mark, add oil.

Checking brake fluid



Check if the brake fluid level is between the "MAX" mark and the "MIN" mark. If the level is near or below the "MIN" mark, add brake fluid.

Checking power steering oil



- Check the power steering oil on level ground.
- Check if the power steering oil level is between the "MAX" mark and the "MIN" mark on the surface of the tank. If the level is near or below the "MIN" mark, add oil.

Checking washer fluid

Check the level of washer fluid on the washer fluid tank and add as needed.

! Caution

- **If the level of engine coolant and various oils drops below the "MIN" mark, have your vehicle checked by KG Mobility authorized service centers.**

Checking belts

Start the engine and see if there is any abnormal noise.

Have the belts checked by our service center according to the periodic inspection and replacement interval table.

Checking tires

! Warning

- **Maintain the tire pressure in a proper condition. Driving the vehicle at a high speed with low tire pressure may cause the tires to burst due to the standing wave effect, resulting in a risk such as a rollover.**
- **Check to see if the wheel nuts (bolts) are tightened. Improperly tightened wheel nuts (bolts) can cause an accident.**
- **Using wheel and tire other than the specified sizes could cause unusual handling characteristics and poor vehicle control, resulting in a serious accident.**
- **The use of tire sizes other than the specified sizes may cause abnormal operation of the steering wheel, increased fuel consumption, increase braking distance, vibration, improper operation of ABS/ESP, or uneven tire wear. It may also damage to the powertrain of the vehicle.**
- **Use only the same tires from same tire manufacturer for all the wheels. Otherwise, the powertrain may be damaged.**

- Always check the tread and side of the tires to see if there is a sign of wear, cracks, or damage.
- Check the conditions and pressure of the temporary (spare) tire as needed and always keep it available. The temporary tire should be replaced with a regular tire as soon as possible.
- Check the conditions of the emergency puncture service kit. The air compressor and sealant canister should be available at any time.
- Check the tire inflation and wear everyday and replace if necessary.



What is the standing wave phenomenon?

The standing wave phenomenon is the occurrence of a wave-shaped wrinkle on a tire with insufficient inflation pressure during high speed driving.

During driving, a tire that has normal inflation pressure repeats compression and restoration, but when a tire with insufficient inflation pressure rolls on the road with high speed, the tire will be compressed significantly and it comes into contact with the road surface again before it is fully restored. If such a situation occurs repeatedly, the standing wave phenomenon will appear.

If the standing wave phenomenon persists, a significant amount of heat is generated on the tire and the tire will be blown out in the end.

Checking the instrument cluster



Check if all the indicators and warning lamps are displayed correctly on the instrument cluster with the ignition switch in ON position.

Also, check if all gauges (fuel gauge, vehicle speed gauge, engine RPM gauge, etc.) are operating properly.

Checking the parking brake

Operate the parking brake to check the parking brake operation status.

If the parking brake is not applied, drive the vehicle after having it checked and repaired by a near-by KG Mobility authorized service centers.

Checking the pedals

Check the operation status of the brake pedal, clutch pedal and the accelerator pedal.

If the operation status of the pedal is abnormal in comparison to its normal status, have it checked and repaired by KG Mobility authorized service centers.

Cleaning up near the driver's seat

Keep the space near the driver's seat clean all the time. Never leave any object that hinders driving.

Always clean up the space near the driver's seat before driving.



Warning

- An empty bottle or an article below the pedal hinders the pedal operation and may cause an accident.
- If the floor mat is not fixed or is too thick, it may hinder the pedal operation and cause an accident.

Advisable driving position



Maintain an advisable position for safe and comfortable driving.

- Sit upright on the driver seat with the hip against the seat cushion.
- Adjust the position and height of driver seat in a way that the brake pedal (clutch pedal) can be depressed to the end comfortably.
- With your back against the seat back, adjust the position and height of the seat back and steering wheel so that you can rest your wrists on the top of the steering wheel.
- Adjust the height of the headrest in a way that the center of the headrest is aligned with the driver's eye level.



Warning

- Do not wear shoes such as slippers or high heels that may hinder driving. Such shoes may hinder the accelerator pedal or brake pedal operation and cause an accident.

Adjusting the seat, headrest, steering wheel, and mirrors

- Adjust the seat, headrest, steering wheel, and mirrors before driving the vehicle.
- If your steering wheel is adjustable, adjust it to an appropriate height and angle that fits your body and drive the vehicle.
- Adjust the rear glasses, side mirrors and room mirror to an angle that you can see the rear view well.



Warning

- If an additional adjustment is necessary while driving, make sure to stop the vehicle at a safe place and make the adjustments. Adjusting while driving may hinder driving, causing an accident.

Wearing the seat belt correctly



- Make sure that all occupants inside the vehicle wear a seat belt.
- Wear the seat belt with your body closely against the seat cushion.
- A child who cannot wear a seat belt should be seated in the rear seat using child restraints.
- For a vehicle where an adjustable top shoulder strap fixing device is provided, wear the seat belt by adjusting the shoulder strap control device to your body type.

Warning

- Do not wear the seat belt under the arm.



- Each seat belt is for one person. Two or more persons should not wear one seat belt together.



- Do not lock the seat belt with a clip or a clamp.



- Insert the seat belt latch only to the relevant buckle.



Danger

No drugged, drunk, distracted and drowsy (4D) driving



- Avoid drugged driving. It is an illegal act that may be more dangerous than drunk driving depending on the type and dosage of a drug.
- Avoid drunk driving. Judgment is impaired under the influence of alcohol, making safe driving impossible. It is also an illegal offense that puts the life of occupants in other vehicles in danger.

- Avoid distracted driving. Using a mobile phone or the navigation system, watching DMB, or eating while driving may decrease your concentration, making a risk of an accident higher. In particular, using a mobile phone or watching DMB while driving is an illegal offense that hinders safe driving. When it is inevitable, stop or park the vehicle in a safe place and use the relevant device.
- Avoid drowsy driving. Driving for a long period of time without taking a rest will lead to drowsy driving that may cause an accident. Take a rest at least every 2 hours for safety.

Warning

Cautions for air bag

- The air bag system is an auxiliary safety device. Wearing the seat belt properly can minimize injury.
- Do not apply impact to the air bag by hand or with other articles. Doing so may cause the air bag to deploy.
- Do not place any object on, the air bag inflation location. You may be injured by those objects during deployment.

- A passenger who is smaller than 140 cm should sit in the rear seat. Otherwise, the passenger may get injured during deployment.
- A safety device for infants and children should be installed on the rear 1st row. Installing it on the front seat may cause a serious injury or death if the air bag is deployed.
- A pet should be restrained in the rear seat using a dedicated safety device. A pet in the front seat may get injured if the air bag is deployed.
- When the air bag is deployed, the relevant components may be hot.
- A deployed air bag cannot be used again. Please replace it.
- The air bag system should be checked or replaced after 10 years from its installation even if the system has no abnormality. The air bag system should be checked or replaced by a professional technician in KG Mobility authorized service centers.
- Do not modify any part of the air bag system arbitrarily. Do not attach any other electrical device to the air bag system.

! Warning

Precautions for infants, children, old people, or pregnant women



- Never leave an infant, a small child or an old person unattended in the vehicle. They may touch a device inside the vehicle, resulting in an accident. When the doors are locked and the windows are closed during summer, the temperature inside the vehicle will increase, resulting in suffocation.
- Do not allow children to use the ignition key, various switches or buttons, and additional devices without permission. Failure to do so may cause car trouble or even an accident. Their body may get caught in the door, window, or sunroof, and receive injury.
- Do not let an infant, a child or an old person sit in the front seat. The impact from the air bag expansion may cause serious injury or death. An infant or a small child should be restrained with a seat belt or protective gear in the rear seat attended by an adult.

! Warning

An infant or a small child must be seated in the rear seat with protective gear



- An infant or a small child should be seated in the rear seat with an adult.
- An infant or a small child should be restrained with a seat belt or proper protective gear. Failure to do so may cause serious injury or death in the event of sudden braking or a collision accident.
- Apply the child protection lock system to the rear doors so that children in the rear seats cannot open the rear doors.
☞ Refer to “Child safety door lock” (p.3-4)

! Warning

No sleeping in a sealed vehicle



- Never sleep in a parked car with all the windows closed. In particular, if you sleep with the air conditioner or heater turned on, you can suffocate to death due to a lack of oxygen.
- If you sleep in a sealed space with the engine running, the exhaust gas may flow in, putting you at risk of suffocation.
- While sleeping, you may accidentally touch the gear shift lever or accelerator pedal and cause an accident.
- If you step on the accelerator pedal continuously while sleeping, the engine and the exhaust system may be overheated, causing a fire.

 Warning

Do not drive with the doors or tailgate open



- Do not drive with the doors open. An occupant may fall out of the vehicle and suffer a serious injury.
- If you accidentally operate the door lever while driving and the door is open, it may cause a risk of a serious accident. In particular, do not allow a small child to touch the door lever while driving.
- If you drive the vehicle with the tailgate open, an article from the inside of the vehicle may fall out, causing an accident.

 Warning

Do not hold a part of your body out of the window or sunroof



- While driving or stopping, do not hold a part of your body such as a hand or head out of the window or sunroof. You may get injured by a passing vehicle or an obstacle.
- In particular, do not allow a child or a pet to hold their hand or head out of the window.

 Warning

Be careful not to have a part of your body caught when using the power window



- Use the power window only after checking that all passengers are safe.
- Before closing the window, check if a part of a passenger's body such as a hand or head is held out of the window and notify them that you will close the window.
- If a small child is seated in the rear seat, press the window lock switch to make the rear window switches inoperative.
 Refer to "Rear seat window lock function" (p.3-19)

! Warning

Check for any vehicles or persons passing by when getting out



- When you get out, make sure to check the rear and the front of the vehicle to see if there is any vehicle or person passing by. In particular, opening the door without checking a vehicle or a motor cycle approaching from the rear may cause damage to the vehicle as well as injury.
- Warn other passengers to check around before opening the door.

! Warning

Safe parking and stopping

- Never leave an infant or a child unattended in the vehicle with the doors and the windows locked after parking or stopping the vehicle. The temperature inside the vehicle may rise, resulting in suffocation or an accident.
- Always apply the parking brake while parking or stopping. Even a flat area may have a slope. Place the gear shift lever in the P (parking) position and always apply the parking brake.
- Do not stop or park on a steep road. The brake system may be released, causing the vehicle to move.
- When you park on a hillside road, make sure to apply the parking brake and place blocks under the wheels or adjust the wheels to face the wall.
- At this time, place the shift lever in the P (park) position for automatic transmission vehicles and in the 1st gear (uphill) or R (downhill) position for manual transmission vehicles.
- If the vehicle with an automatic transmission, do not use the P (park) position as an alternative to the parking brake, make sure the parking brake is firmly applied during parking.
- Do not park or stop at a place with flammable materials. The heated exhaust pipe may cause a fire.

- If the rear side of the vehicle is too close to a wall, warming up the vehicle for a long period of time, or idling the engine at a high speed may cause the wall to be discolored, or cause a fire due to the heat from the exhaust gas. Keep a proper distance.
- If possible, do not park the vehicle in a humid area or a poorly ventilated area.

! Warning

Warming up the engine correctly

- Drive after warming up the engine properly. Driving immediately after starting the engine may decrease the engine's life expectancy.
- Warm up the engine just until the coolant temperature gauge begins to move. The warming up period may vary according to the outside temperature.
- Do not depress the accelerator pedal and increase the engine RPM rapidly during the warming up period. Doing so may damage the engine.
- Do not warm up the engine excessively. Doing so increases the fuel consumption and air pollution.
- Do not warm up the engine in a sealed space. Exhaust gas may flow indoors, resulting in gas poisoning.



Warning

Do not stop the engine while driving

- Do not stop the engine while driving. Doing so may make the steering wheel heavier and lower the brake performance, becoming very dangerous.

However, if you need to stop the engine in an emergency situation while driving due to an accident or a vehicle damage, refer to the following.

☞ Refer to “Stopping the engine while driving (in the event of emergency)” (p.4-12)



Warning

No sudden starting, acceleration or braking

- Do not start, accelerate, or brake the vehicle suddenly. Doing so may increase the fuel consumption or cause an accident.
- Accelerate or decelerate the vehicle gently.



Warning

Driving on unpaved and mountain roads

- Before driving, check road conditions in advance to see if the road ends suddenly, or if there is enough space to make a U-turn for emergencies.
- In sandy or dry roads with much soil, the vehicle may slide easily. Keep your speed low and steady.
- Drive carefully on mountain roads, since the outer part of the road has a danger of collapsing.
- When driving downhill, downshift, and drive slowly by applying the engine brake.



Warning

In high mountain area

- The operation stability of diesel engine is not guaranteed in high mountainous area over 2,500 meters. The short trip such as passing through tunnel in this area is acceptable. However, do not keep driving there for a long time. If you drive your vehicle in very high altitude for long time, the engine could be damaged. The engine power, climbing ability and emission are subject to the altitude.



Warning

Driving on a snowy or icy road

- If possible, drive slowly.
- Since the braking distance is longer than usual, maintain a proper distance from the car ahead.
- Accelerating or braking suddenly may cause your vehicle to slide, resulting in an accident.
- When you drive on a frozen or slippery road, use the engine brake after decelerating properly. Applying the engine brake suddenly may cause your vehicle to slide, resulting in an accident.
- Apply your brakes after decelerating the vehicle speed properly using the engine brake.
- Use snow tires for safer driving when driving on a snowy or icy roads.



Warning

Driving on a sandy or muddy road

- Keep your speed as low and steady as possible.
- Accelerating or stopping suddenly while driving may cause the vehicle to be caught in the sand or mud.
- If the vehicle is caught in the sand or mud, place a stone or a wooden plate below the wheels and drive off from the sand or mud. Or, depress the accelerator pedal slowly and drive off using inertia by forwarding and reversing repeatedly.
- If you depress the accelerator pedal excessively to drive off from the sand or mud, the tires may slip, causing damage to the transmission and relevant driving systems. If possible, have your vehicle towed by another vehicle.



Warning

Driving on a hillside road and downhill road

- Downshift in accordance with the road conditions.
- If you apply the engine brake suddenly while driving on a hillside road or a downhill road, the engine may get damaged. Reduce the vehicle speed and downshift.
- Use the brake pedal and the engine brake together on a long downhill road. Applying the brake pedal continuously on a long downhill road may overheat the braking system, lowering the braking performance and resulting in an accident.



Warning

Driving on a road with a pool of water or a river

- Avoid crossing a road with a pool of water or a river if possible. If water gets into the engine or the electric systems, it may cause serious damage to your vehicle.
- If you need to cross a road with a pool of water or a river unavoidably, select a shallower part where the exhaust pipe will not be submerged under water and cross slowly at a constant speed.
- Before crossing a river, get out of the vehicle and check the bottom of the river. Do not cross through a place where the bottom is sandy or covered with big rocks.
- If several vehicles cross the river together, the path where the vehicle ahead has crossed may have caved in. Cross through a different path if possible.

Cautions for crossing

- If the engine stops while crossing a road with a pool of water or a river, do not restart, and have your vehicle towed.
- Take particular caution not to allow water to enter into the engine through the air cleaner.
- Never change gears while crossing a road with a pool of water or a river.

Checking the vehicle after crossing

- If water gets into brake-related equipment, the brake performance will be lowered. After crossing a road with a pool of water or a river, drive slowly and depress the brake pedal slightly several times. Drive normally after drying the brake discs with the frictional heat and checking the braking performance.
- Check the parts at the bottom of the vehicle where oil and fluid are injected. If you discover any problems, have your vehicle checked immediately.
- Check the lamps and other electrical devices and replace them if necessary.
- Check for any damage on the vehicle body or at the bottom of the vehicle. If you discover any problems, have your vehicle checked immediately.
- If your vehicle is heavily soiled, wash your vehicle to protect the vehicle body.



Warning

Do not use a cellular phone or watch DMB including DVD while driving

- Using your cellular phone or watching DMB (including DVD) while driving will distract yourself and may cause an accident. If necessary, pull over your vehicle safely to use your cellular phone.



Warning

Driving on the expressway

- Before driving, check the weather information in advance, and check the fuel level, brake system, cooling system, level of tire wear and pressure, and maintain the vehicle thoroughly.
- Drive slowly for 2km after starting if possible.
- Always observe the speed limit and do not drive too fast.
- Keep a proper safe distance from the vehicle ahead.
- In case of bad weather, maintain more than twice the safe distance from the vehicle ahead than usual and reduce the speed by more than a half.
- Do not load the vehicle with unnecessary articles.
- Check and maintain the vehicle periodically to maintain the best vehicle condition.



Warning

Crossing an intersection or railroad crossing

- When you cross an intersection or railroad crossing, stop first, check for safety, and then cross promptly using a lower gear, without shifting if possible.
- If the engine stops in the middle of an intersection or railroad crossing, move the vehicle to a safe place promptly. If necessary, ask people around for help.

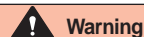

Warning

No sudden maneuvering of the steering wheel

- If you maneuver the steering wheel suddenly, the driving condition of the vehicle may become unstable, causing the risk of an accident.



Warning

Do not warm up the engine or check the vehicle in a sealed space

- Do not warm up the engine or check the vehicle in an airtight or badly ventilated space. The exhaust gas from the vehicle may cause gas poisoning.

 **Warning**

Do not load hazardous materials

- Do not store any flammable materials such as gasoline, butane gas, or a disposable gas lighter, or explosive materials inside the vehicle. If the indoor temperature rises, the container may burst, causing a fire.

 **Warning**

Use of the engine brake

- When driving on a long downhill road, use the engine brake and the foot brake at the same time. When you downshift according to the driving conditions, the engine brake will operate.
- Using the foot brake excessively may cause the fade or vapor lock phenomenon due to overheating of the brake system, lowering the braking performance.

What is the fade phenomenon?

The fade phenomenon is the reduction of braking force due to a decrease in the friction force caused by a temperature increase in the friction surface of brake when the brake is applied excessively on a long downhill road.

What is the vapor lock phenomenon?

The vapor lock phenomenon is the condition that when the brake is applied excessively on a downhill road, bubbles form in the brake fluid in the wheel cylinder or brake pipe of the hydraulic brake so that proper hydraulic pressure cannot be transferred, causing the brake system not to operate properly even if the pedal is depressed.

 **Warning**

Special cautions when checking the coolant

- Never open the engine coolant reservoir cap when the engine is hot. Doing so may cause hot steam or coolant to erupt, causing burns on your body parts including the hands or face.

 **Warning**



Do not remove the coolant reservoir cap when the engine and the radiator are hot. The cooling system may spray hot coolant if the cap is removed, causing serious injuries.

 **Warning**

Cautions for attaching accessories

- Do not attach accessories or unnecessary articles to the vehicle windows. They may interfere with your driving, and if attached accessories act as a lens (magnifying glass), a fire or an unexpected accident may occur.

 **Caution**

Cautions for vehicle ventilation

- For a new vehicle purchased within 1 year, harmful volatile organic compounds (VOC) to human body may be emitted in the cabin. In particular, riding a vehicle exposed to direct sunlight for a long period of time or without proper ventilation may cause headache, dizziness or nausea.
- Operate the fresh air inflow mode or open the windows periodically to ventilate air inside the vehicle for the health of passengers and a pleasant vehicle environment.



Caution

System protection function (delayed accelerator pedal response)

- Do not depress the brake pedal while driving with the accelerator pedal depressed. Doing so may affect the vehicle driving system and the response from the accelerator pedal may be delayed.
- This symptom is a safety function to protect the vehicle system. This symptom will disappear if you depress and release the accelerator pedal once with the brake pedal not depressed.



Caution

Placement of extinguisher

- An extinguisher is an essential item for early extinguishing when a fire occurs. It is recommended to purchase it from a fire-fighting appliance store and place it in the vehicle.

KG Mobility authorized service centers and maintenance partners

KG Mobility authorized service centers or maintenance partners for checking and repairing the vehicle. If you use other service centers or maintenance shops, warranty repair will not be available and warranty will not be provided for any consequent problems.

Cautions for the depletion of battery when connecting uninterruptible power supply to the black box system

If the vehicle is not operated for a long period of time with the uninterruptible power supply connected to the black box system, the vehicle battery may be depleted.

Turn off the black box system if you will not drive the vehicle for a long period of time.

Long-term parking mode

This mode is for preventing vehicle battery discharge. Set it on the instrument cluster and use it if necessary.

During setup, smart key search is stopped to minimize power and some functions are limited.

Breaking in a new vehicle correctly

Break-in is not required for a new vehicle. However, the driving condition for the first 1,000 km significantly affects the life and performance of the vehicle. Pay attention to the following when driving during this period.

- Allow the engine to reach normal operating temperature before driving.
- Do not speed, accelerate, brake suddenly, or idle the engine excessively.
- Shift properly according to driving speed.
- Do not overload the engine while driving a sloping road.
- Do not tow a trailer during the first 1,000 km.
- During the first 1,000 km of towing a trailer, do not drive at a speed over 80km/h or with full acceleration. Doing so may damage the engine or other components due to overload.
- Check the level of engine oil frequently until the first 5,000 km of operation and add oil if necessary.

Using genuine parts

Always use genuine parts for maintaining safety and the best performance of your vehicle. Warranty repair will not be provided for car trouble caused by using a non-genuine part.

You can verify a genuine part by its hologram and sticker with the product number.



Caution

- **The warranty does not cover problems caused by using non-KG Mobility genuine parts.**
- **You can distinguish an authentic KG Mobility genuine part by its hologram.**

Vehicle washing

After driving on a coastal road (salty road), a road where calcium chloride was spread, an area with excessive smoke or coal tar, or a muddy or dusty area, or when the vehicle is stained with tree sap or insects' or birds' droppings, wash the vehicle immediately since corrosion may occur on the vehicle body.

- Avoid direct sunlight and wash the vehicle in the shade. If your vehicle has been parked under direct sunlight, let it cool properly before washing.
- Dust off the vehicle with cold water.
- Mix cold water with detergent in a bucket and wipe the vehicle from top to bottom using a soft brush, sponge, or cloth.
- Wash off any foreign materials on the vehicle body without damaging the painted surface.
- Any scratched or damaged painted surface causes corrosion, so repair them with paint for repair.
- Remove moisture using a dry and soft cloth.
- After washing, drive the vehicle normally after driving it slowly, and checking the operating status of the brakes.

Caution

- **Be careful not to damage the air spoiler when cleaning the vehicle in an automatic car wash.**
- **When you wash the bottom or exhaust pipe of the vehicle with water (including high pressure washing), be careful not to damage the sensors or connectors connected to the exhaust pipe and prevent water intrusion. Our warranty will not be provided for any consequent failure.**
- **Avoid washing with water when the brake discs are hot. Hot brake discs may be deformed or damaged if it comes into contact with water.**
- **If possible, avoid high pressure washing for maintaining and managing the vehicle performance.**
- **High pressure washing may damage the components and sensors installed on the exterior of the vehicle and the painted surface of the panels. In particular, be careful not to get water into the electrical devices and sensors at the bottom of the vehicle.**
- **When you use high pressure washing unavoidably, maintain a proper distance between the high pressure water nozzle and the vehicle. If the distance is too close, the sensors on the bumper may malfunction or the painted surface of the panels may be damaged due to the high water pressure.**



- **Do not use abrasive wax and strong cleaning materials such as steel wool which will scratch the vehicle body and bumper.**
- **Do not wash the engine compartment using liquid materials such as water or wax. If liquid materials get into the inside of the engine through the electrical devices (sensors) or air ducts located in the engine compartment, various electrical devices may malfunction or the vehicle's operation may not be possible.**

Washing the bumper

- Wipe off foreign materials using a soft sponge.
- If the bumper is contaminated by engine oil or any lubricants, wash it off using soapy water.



Caution

- **Do not use abrasive wax or a brush to wipe the bumper or the vehicle body. Doing so may damage the bumper or the surface of the vehicle body (painted surface).**

Washing wheels

Clean the wheels after driving on a salty road to prevent the wheels from being corroded.



Caution

- **Do not use abrasive cleaners, polishes, solvents, wire brushes, and high speed washing brushes since they may damage the wheel surface.**
- **Using acid or alkaline detergents could damage the wheel surface (painted surface), so use neutral detergents for cleaning the wheels.**
- **Using strong cleaners may discolor the wheel surface. Make sure to use natural cleaners. A discolored wheel due to carelessness is not subject to free warranty repair.**

Cautions for polishing the vehicle

- Before waxing, remove dust or moisture from the vehicle.
- Apply a small amount of wax on a soft cloth, apply it to the whole vehicle body evenly, and scrub a wide area in the same direction to polish.
- After waxing, remove residual wax from the vehicle body completely.



Caution

- **Do not polish or wash the vehicle body using wax containing abrasives. Doing so may damage the surface of the vehicle body (painted surface).**

Cleaning and maintaining glass

- Clean the indoor and outdoor sides of glass windows using a glass cleaner and a soft cloth.
- When cleaning the glass windows, be careful not to damage the electric demister element.
- When automatic car washing is used, coating (wax) substance included in the cleaning fluids may adhere to the glass surface and it may not be wiped off easily when it is dried. Spray washer fluid and operate the wipers two or three times to remove coating (wax) substances using the cleaning substances included in the washer fluid.
- Do not wipe the glass surface with a towel stained with oil or wax. Doing so may cause vibrations and abnormal sounds when the wipers are operating and the front and rear windshields may not be cleaned properly when it rains. Also, the reflection of light may occur at night, causing poor visibility and affecting safe driving.

Cautions for window tinting

- All vehicles from our factory have tinted windshields and rear windows that meet the specified percentage of visible light transmission (VLT). Do not tint the windows of the product. Doing so will lower VLT, becoming subject to legal regulation.
- Tinting the windshield and rear window excessively may reduce front and rear visibility at night or in case of rain, causing an unexpected risk.
- When tinting the windshield and rear window, do not allow working solutions to enter into electrical and electronic devices. Failure to do so may cause a malfunction or failure of electrical and electronic devices.
- If the windshield and rear window are modified or tinted arbitrarily, the electric demister element may be damaged by a knife or a tool or an electrical shock.
- If the windshield and rear window are coated or tinted (metallic tinting film), the Hi-Pass system, rain sensor, and radio may not operate normally.
- Do not tint the front camera sensing part. Otherwise, the relevant system may malfunction.

Care and cleaning of the interior

- Use a dry towel for normal cleaning.
- For synthetic resin such as plastic, clean it with lukewarm water and soap and wipe off with a wet towel with no soap.
- Wipe using a dry towel to dry.
- Remove dust on the seats and mats using a vacuum cleaner.
- If the mats are heavily stained, spray a cleanser on them and wipe using a cloth.



Caution

- **When you use chemicals for cleaning the interior, the color or shape of the interior may change.**
- **Do not use chemical products such as acetone, enamel, and bleach for cleaning the interior.**
- **The Leather Seat Maintenance is necessary on Quarter basis with dedicated Leather Milk or Cream in order to feed the Leather and avoid any cracks on the seats and conserving the original look and comfort of the seat.**



Warning

- To prevent from burning and electric shock, turn off the interior lights before cleaning the vehicle interior.

Seat Belt Care

- Keep belts clean and dry.
- Clean seat belts only with mild soap and lukewarm water.
- Do not bleach or dye belts since this may severely weaken them.

Cautions for using the vehicle key

- Be careful not to lose your key.
- If your key is lost or stolen, replace the whole key set to prevent the vehicle from theft.
- Do not throw or drop your key. Doing so will damage your key. Do not drop your key in water.
- Use only the same standard battery for the key and be careful not to switch the polarity when inserting the battery.

Corrosion protection

Your car was designed to resist corrosion. When it was built, special and protective finishes were used on most parts of your car to help maintain a good appearance, strength and reliable operation. Some parts which normally are not visible (such as certain parts located in the engine compartment and the underbody of the vehicle) are such that surface rust will not affect their reliability. Therefore, corrosion protection is not needed or used on these parts.

Sheet Metal Damage

If your car is damaged and requires body panel repair or replacement, make sure the body repair shop applies proper anticorrosion material to the parts repaired or replaced so that corrosion protection is restored. (Also refer to "Finish Damage" on the next page).

Foreign Material Deposits

Calcium chloride and other salts, deicing agents, road oil and tar, tree sap, bird droppings, chemicals from industrial chimneys and other foreign materials may damage vehicle finishes if left on painted surface. Prompt washing may not completely remove all of these deposits. Other cleaners may be needed. When using chemical cleaners, be sure they are safe for use on painted surfaces.

Finish Damage

Any stone chips, fractures or deep scratches in the finish should be repaired promptly. Bare metal will corrode quickly and may develop into a major repair expense. Minor chips and scratches can be repaired with touch-up materials. Larger areas of finish damage can be corrected in your Distributor's body and paint shop.

Underbody Maintenance

Corrosive materials used for ice and snow removal and dust control can accumulate on the underbody. If these materials are not removed, accelerated corrosion (rust) can occur on underbody parts such as the fuel lines, frame, floor pan, and the exhaust system even though they have been provided with corrosion protection. At least every spring, flush these materials from the underbody with plain water. Take care to clean any area where mud and other debris can accumulate.

Sediment packed in closed areas of the frame should be loosened before being flushed. If desired, your KG Mobility Distributor can do this service for you.



Caution

- When the engine is washed, fuel, grease or oil residues are washed off. Therefore you should use only a filling station or a KG Mobility Distributor who has oil separator equipment in the car wash bay.
- Used engine oil, brake fluid, transmission fluid, antifreeze, batteries, and tires should be disposed of using the local authorized waste disposal facilities, or have them disposed of by the vendor who is under a statutory obligation to do so when you replace them.
- None of these items should be placed in the household recycling bins or poured into the sewage system.
- Everyone should be concerned about environmental protection.
- Help by doing your share.
- When a strong multi-purpose, acid, or alkaline detergent is used to clean up the surface of the painted body, side mirrors, windshield, plastic moldings or leather, changes, fading of colors or rusting can happen.

- When the windshield is cleaned with an oil-contained or waxed towel, strange sounds and vibrations may occur on the windshield surface when the wipers are operating. Also, decreased visibility, reflection at night, or poor removal of water on the windshield may happen. Do not clean the windshield with an oil-contained or waxed towel.
- An abrasive detergent may damage the painted surface of your vehicle, including the bumper. Do not buff or polish your vehicle with an abrasive detergent.
- An acid or alkaline detergent may damage the painted surface of the aluminum or alloyed wheels.
- When chemical products are used to clean up the interior, the chemical products may change some colors or distort the shape of some interior parts.
- When cleaning up interior parts, do not use chemical products such as acetone, enamel or bleach.

System safety mode

The protective measures including illumination of engine warning lamp and reduced engine power are taken (engine turned off in worst case) when there is a critical fault in the system or a malfunction in the major electrical or fuel system. This indicates the system entering the safety mode to protect the vehicle's drive system.



Danger

- If the safety mode is activated, pull over and stop the vehicle to a safe location immediately and contact your KG Mobility dealer. Then drive slowly or have the vehicle towed to a KG Mobility Dealer or KG Mobility Authorized Service Center according to the dealer's instruction and have your vehicle checked by a mechanic.
- If you continue to drive in this state, normal driving is not maintained due to the fixed engine rpm and engine can stop. But even more importantly, continued driving with this state may damage the drive system.

Vehicle Fueling from Drums or Storage Containers

For safety reasons (particularly when using noncommercial fueling systems) fuel containers, pumps and hoses must be properly earthed.

Static electricity build up can occur under certain atmospheric and fuel flow conditions if unearthed hoses, particularly plastic, are fitted to the fuel dispensing pump.

It is therefore recommended that earthed pumps with integrally earthed hoses be used, and that storage containers be properly earthed during all noncommercial fueling operations.

Fuel recommendation

Commercially available high-quality fuels are suitable. Fuel quality has a decisive influence on the power output, driveability and life of the engine. The additives contained in the fuel play an important role in this connection. You should therefore use only high-quality fuels.

Diesel Engine

Use diesel fuel at 50 cetane rating or higher.

Gasoline Engine

Fuel with too low an octane number can cause pre-ignition (detonation). KG Mobility can not be held liable for resultant damage.

Fuel Recommendation

Type	Unleaded gasoline (Octane number 95 or higher)
------	---



Caution

- For correct octane rating setting and other use of gasoline (ex. Leaded), consult your KG Mobility Dealer.



Caution

Engine and exhaust system will be damaged.

- Do not use leaded fuel to the vehicle for unleaded fuel.
- Use the fuel with specified or higher Research Octane Number recommended for your country by KG Mobility.

It is not covered by warranty.

Do not Use Methanol

Fuel containing methanol (wood alcohol) which is not qualified EN228 and EN590 standards should not be used in your MUSSO & MUSSO GRAND. This type of fuel can reduce vehicle performance and damage components of the fuel system.

The warranty policy will not cover damage of the fuel system and any performance problems that are caused by the use of methanol or fuel containing methanol.

Using biodiesel fuel and low quality fuel

The fuel system of the common rail direct injection engine is precisely machined component. Using low quality fuel and excessive biodiesel fuel could result in a serious damage to the engine due to the water, impurities or suspended particles in fuel.

Using fuel mixed with too much biodiesel fuel can cause fuel filter clogging, power loss, engine idling problem, engine stall, difficulty with starting the engine in cold weather as well as damage to the engine and the fuel system, due to the naturally produced suspended particles.

Currently, the KG Mobility vehicle is designed so that only the mixed fuel of biodiesel and diesel with mixing ratio within the specified range can be used for safety. If any product in which the biodiesel fuel is exceeds the total amount of fuel is used or the aftermarket biodiesel fuel is added to the regular fuel, it can lead to malfunctions in the vehicle and this is not covered by warranty.

What is "Bio-diesel"?

The bio-diesel fuel is made by reacting vegetable oil extracted from beans, rapeseed, rice bran, etc. with alcohol. This can be solely used or used mixed with the diesel fuel for the diesel engine as its physical and chemical characteristics are similar to those of the diesel fuel. This is considered to be alternative energy to the diesel fuel nowadays.

Engine check indicator

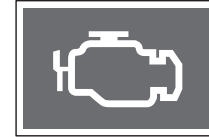

The engine check indicator on the instrument cluster turns on when the fuel system of the engine or main electrical systems are not working properly. At this time, the driving power of the engine may decrease or the engine may turn off.

If it occurs, have your vehicle checked and maintained by our service center.

Other maintenance

After driving on a calcium chloride (salt) spayed road, wash the bottom of your vehicle as soon as possible to avoid any rust.

When parking on a snow-covered road, the brake system may begin to have some ice on it. The ice will decrease your vehicle's braking ability. If this happens, drive at a low speed and use the brake frequently to remove the ice. After regaining the braking ability, drive your vehicle at a normal speed.



Warning

- When there is ice on the wiper blades, turning on the wiper switch may put an extra burden on the wiper motor and damage it. Avoid using the wipers when ice is on the blades.
- When driving on a snow-covered road, a large amount of snow may build up under each wheelhouse. This buildup prevents the steering wheel from moving freely. Therefore, remove the snow buildup frequently.

Diesel fuel in winter

On an extremely cold day, paraffin, one of the chemicals in diesel fuel, may separate from the diesel fuel. This separation makes starting the engine difficult. During the winter season, Kerosene is added to diesel in some markets to prevent the paraffin separation and secure stable flow of the fuel through the fuel filter. The amount of added Kerosene into diesel can vary by location and their average winter temperatures. Therefore, to ensure an easy start on a cold day, park your vehicle inside of a garage. If possible, fill up the fuel tank after each driving to prevent ice from forming inside of the fuel system.



Caution

- Change engine oil and the fuel filter as scheduled. Contaminated engine oil will lose its viscosity, clog the fuel filter and oil filter and cause difficulties starting the engine.
- Do not add any additives other than the genuine fuel for better startability at owner's disposal. The additive may decrease the lubricating ability of the internal fuel system; the additive may have a different flashing point. This will damage the fuel system or produce an excessive exhaust fume.

2. Safety Units

You can check information regarding units that allow you to drive the vehicle safely and how to use such devices.

An explanation is provided for seat belts, a child restraint for an infant or a small child, airbags, anti-theft and warning system.

Seat belt

The seat belt is the most fundamental safety unit that protects an occupant and prevents or reduces injury when an accident occurs.

If you do not fasten the seat belt or fasten the seat belt incorrectly, the seat belt does not function properly and you may also get injured by the seat belt.



Warning

- **All occupants must fasten their seat belt before driving. Failure to do so may lead to a fatal accident, in case of emergency or when the brake is applied suddenly.**
- **The air bag can ensure the safety only when the seat belt is fastened correctly. If the air bag inflates when you do not fasten the seat belt or fasten it incorrectly, you may get injured by the inflated air bag.**

Seat belt warning

If the occupants in the driver seat and the front passenger seat do not fasten their seat belts, the warning lamp on the instrument cluster blinks along with a warning buzzer.

The rear seat reminder illuminates the warning lamp or sounds the buzzer depending on the vehicle conditions and whether the seat is occupied or not.

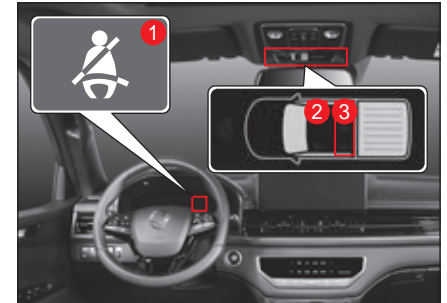

- 1 Warning lamp for driver and front passenger
- 2 Front passenger warning lamp (comes on simultaneously with the instrument panel warning light)
- 3 Rear seat (left, center and right) warning lamp*

Front seat (driver / passenger*) belt reminder

- The seat belt reminder warning lamp and buzzer are triggered only when the ignition switch is turned on or the engine is started.
- If you turn the ignition switch on or start the engine with the seat belt not fastened, the warning buzzer sounds and warning lamp flashes for about 6 seconds. At this time, when the seat belt is fastened, the warning buzzer stops and the warning lamp flashes for the rest of the time.
- If you turn the ignition switch on or start the engine with the seat belt fastened, only the warning lamp flashes for about 6 seconds.
- If you fasten and then unfasten the driver seat belt, the warning buzzer sounds while the warning lamp flashes for about 6 seconds. However, for the passenger seat, the warning lamp and buzzer do not work even if the seat belt is fastened and then unfastened.
- When driving the vehicle at a speed of about 10 km/h or higher with the seat belt not fastened, the warning lamp comes on for about 100 seconds and the warning buzzer sounds. After 100 seconds, the warning buzzer stops and only the warning lamp stays on.

Rear seat (left / center / right) belt reminder*

- The rear seat belt reminder warning lamp comes on for 70 seconds when the ignition switch is turned on regardless of whether the seats are occupied or not and the warning buzzer does not sound.
- The rear seat occupancy sensor recognizes that the corresponding seat is occupied when the rear seat belt is fastened and then unfastened with the ignition switch turned on.
- If the seat belt is fastened when the warning lamp comes on for 70 seconds by turning the ignition key on the corresponding warning lamp goes off.
- If the rear seat belt is fastened and then unfastened at a vehicle speed of 10 km/h or less, the corresponding warning lamp stays on until the seat belt is fastened. At this time, the warning buzzer does not sound.
- If the rear seat belt is fastened and then unfastened at a vehicle speed of 10 km/h or higher, the corresponding warning lamp keeps flashing until the seat belt is fastened and the warning buzzer sounds for 70 seconds.
- The rear seat occupancy is reset when: the rear door is open and closed with the vehicle stationary (speed of 0 km/h) and ignition switch turned on.

Caution

- **The passenger seat belt warning operates only when an occupant on the front passenger seat is detected. When the occupant on the front passenger seat is positioned inappropriately or is too small, the occupant may not be detected.**
- **When an object is placed on the front passenger seat, the occupant detection sensor may operate and the passenger seat belt warning may operate.**
- **If the warning lamp or the warning buzzer persists after fastening the seat belt, have your vehicle checked and serviced at a KG Mobility Corporation authorized service center.**

Notice

- **Seat belt warning may persist until the seat belt is fastened depending on the vehicle condition.**
- **When the gear shift lever is maintained at the R (reverse) position for 1.5 seconds or longer, the seat belt warning (reminder) does not operate.**

Fastening the seat belt

- 1 Sit upright on the seat with the hip against the seat cushion.
- 2 Hold the seat belt latch and pull it slowly in the direction of the buckle.

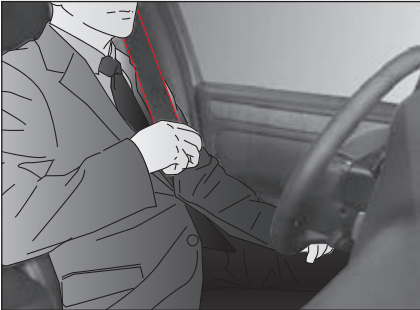

Warning

- Wear the seat belt in a way that it is not twisted. If the seat belt is twisted, it cannot distribute the impact at the time of an accident properly.

Notice

- If the seat belt is locked and does not move, loosen the seat belt a little bit and pull it slowly or strongly. In some cases, you have to pull the seat belt strongly for approximately 2 to 3 seconds to move it.

- 3 With the shoulder belt webbing positioned across the chest and the lap belt webbing positioned across the hips, insert the belt latch into the buckle until it clicks.

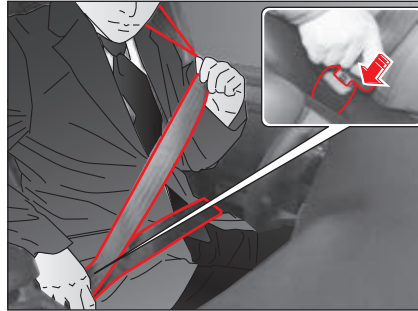

Warning

- Fasten the seat belt in a way that the shoulder belt webbing is positioned across the chest. If the shoulder belt webbing is positioned across the neck, a serious injury may occur by the belt in the event of an accident.
- Position the lap belt webbing as low as possible across the abdominal area. If the lap belt webbing is positioned across the abdominal area, an impact may happen in the event of an accident, resulting in a serious injury.
- Pull the belt latch to make sure that it is securely locked into the buckle.

- 4 Adjust the height of the shoulder belt webbing using the seat belt height adjuster if needed.
- 5 Adjust the belt webbing on the chest and the hips to not be slack.

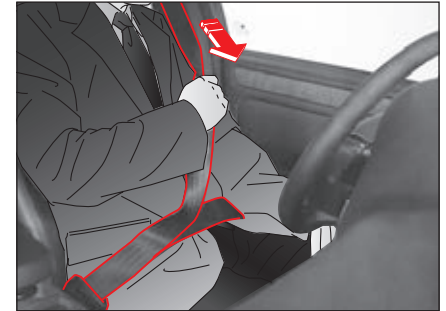

Warning

- Do not fasten the seat belt higher than the body or loosely. Doing so may cause the body to slip below the seat belt in the event of a collision accident, resulting in injury.

Unfastening the seat belt

- 1 To unfasten the seat belt, press the red button on the buckle and separate the belt latch from the buckle.



- 2 Hold the belt latch and let the seat belt webbing to be wound slowly.

Managing the seat belt

Adjusting the height of the front seat belt

You can adjust the height of the shoulder belt anchorage to prevent the seat belt from being positioned across the neck.

Warning

- Adjust the height of the seat belt before driving.

- 1 With the top of the seat belt height adjuster pressed, raise or lower the seat belt holder.



- 2 Release it at the desired position.
The seat belt holder is secured.

Stowing the rear seat belt

If you do not use the rear seat belts or wish to fold the rear seat back, insert the seat belt into the webbing guide installed on the wall as shown in the figure.

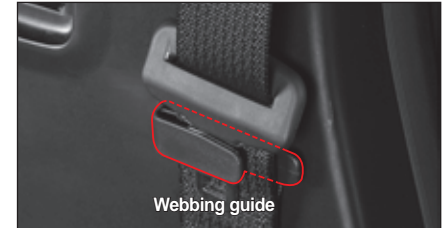

Caution

- Remove from the webbing guide first if you wish to use the seat belt. Pulling the seat belt with the webbing guide inserted may damage the webbing guide or the seat belt.

Stowing the rear buckle

If you do not use the rear seat belts, insert the buckle into the buckle storage as shown in the figure.



How to fasten the seat belts (2-point) in rear seat

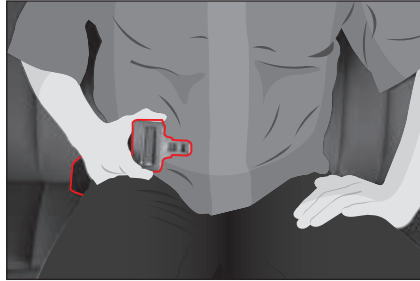

1 Pull out the latch plate at the bight of the seat.



Warning

- Put the lap belt as low as possible across the hips. Do not put it across waist. In an accident, the belt may apply pressure to your abdomen. This may cause serious internal injuries.

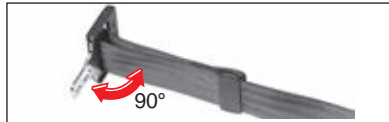

To lengthen, hold the metal latch plate at a right angle to the belt and pull the belt. To shorten, pull the free end of the belt away from the latch plate, then pull the belt clip to take up the slack.

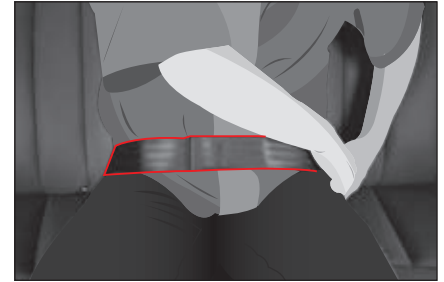

2 Insert the metal latch plate into the buckle until it clicks. Position the belt as low as possible across your hips, not across your abdomen.



3 If the belt is too tight or slack on your hips, readjust the belt.

4 To unfasten the seat belt, press the red button on the buckle.



Warning

- Make sure to fasten the seat belt according to the order as described so that it functions properly.
- To prevent the seat belt from bumping against the rear glass, unfasten the seat belt while holding it.
- This seat belt is designed only for a passenger who sits on the center seat in the rear seat.
- Tug on the seat belt to make sure that the latch plate is securely locked.
- Make sure that the seat belt is not twisted.
- Improper wearing of seat belts increases the chance of injury or death in case of a collision.
- Position the seat belt away from your neck and abdomen.



Caution

- Stow the seat belt into the console when it is not in use.

Seat belt pretensioner and load limiter

The seat belt pretensioner and the load limiter are the units that operate at the same time when the driver and front passenger air bags operate, increasing the safety effect of the seat belt and the air bag.

Pretensioner

The seat belt pretensioner is a protection unit that draws back the seat belt on the occupant's chest and hips instantaneously and secures the occupant to the seat to prevent the occupant from bouncing forward in the event of a strong front collision.

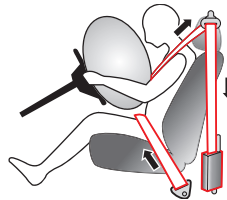

Danger

- The seat belt pretensioner is designed to operate only once. After it operates, replace the seat belt.

Load limiter

The seat belt load limiter is a protection unit that releases the seat belt right after a vehicle collision to prevent a secondary injury due to belt force.

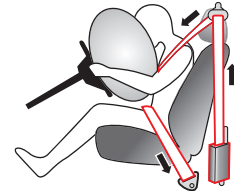

Fastening the seat belt by a pregnant woman

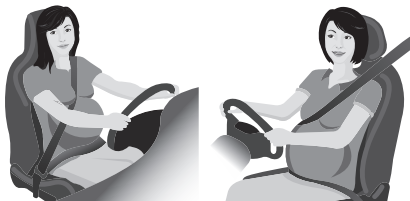

Warning

- It is dangerous for a pregnant woman to drive, so please avoid it if possible. If it is unavoidable, consult a doctor about the precautions and fastening the seat belt during pregnancy.
- Fasten the seat belt before driving. If an accident occurs without fastening the seat belt, may be dangerous for both the pregnant woman and the fetus.
- When a pregnant woman fastens the seat belt, make sure that the belt is not positioned across her abdomen. If the belt presses her abdomen, in the event of a vehicle collision or when applying a sudden brake, may be dangerous for both the pregnant woman and the fetus.

Warnings for the seat belt

Warning

Infants, small children, pregnant women or patients

- The child restraint should be used for an infant or a small child. In particular, please note that the three-point seat belt is designed for a person who is taller than 140 cm.
- In the event of a sudden stop or an accident while a pregnant woman or a patient is wearing the seat belt, strong force may apply to the abdomen or other body parts. Make sure to consult a doctor before fastening the seat belt.

Position and method to fasten the seat belt

- The seat belt is designed for only one person. Two or more persons should not share one belt.
- If the position of the seats is incorrect, it is impossible to fasten the seat belt correctly. Always adjust the position of the seats to their normal status for driving.
- Fasten the seat belt after keeping the seat upright and leaning the back against the seat backrest with the hip against the seat cushion. If the seat belt is positioned too high or fastened too loose, the body may fall out from the shoulder belt webbing or the lap belt webbing, resulting in a serious injury or death.

- If a strong impact occurs while the seat belt is fastened with the seat backrest reclined too much, the body may fall out below the belt, causing the belt to hang around the neck and result in a serious injury.
- If the seat belt is positioned across the neck, a serious injury may occur by the seat belt when an accident occurs. Make sure to wear the three-point seat belt in a way that the belt webbings are positioned across the chest and the hips.
- Do not pull your arm over the shoulder belt. Doing so prevents the seat belt from effectively blocking the body from bouncing forward in the event of a collision. A head or neck injury may occur accordingly and the impact is applied to the ribs that are weaker than the shoulder bone, causing a serious injury.
- When the shoulder belt webbing is positioned across the abdomen, the body may fall out below the belt or a great impact may be applied to the abdomen, causing a serious injury such as intestinal rupture.
- If the belt latch is inserted into another buckle that is not the relevant buckle, the safety belt may not fit the body correctly so that it cannot protect the body properly.
- In addition, if the lap belt webbing of the two-point seat belt is too loose or the seat belt is fastened incorrectly, just as fastening a twisted seat belt, a fatal injury may occur in the event of an accident.

No modification of the seat belt and no attachment of illegal fixtures

- A modified seat belt cannot guarantee safety. Never modify the seat belt.
- Inappropriate work on safety units may adversely affect or hinder the operation of the units. Be sure to have the safety units serviced at a KG Mobility Corporation authorized service center that possess the required expertise, knowledge and special tools.
- If you attach an auxiliary device or accessory to the seat belt separately, the seat belt may not operate normally. Never attach any auxiliary device or accessory to the seat belt.
- Do not loosen the seat belt by locking it with a clip or a clamp. Doing so may cause a fatal injury due to a secondary impact in the event of a collision.

Checking and managing the seat belt and the importance of safe driving

- Do not allow foreign materials to enter into the seat belt buckle.
- If the seat belt and the relevant components are damaged, the seat belt may not operate normally. Check the seat belt frequently for any damage and the status of normal operation, and if any abnormality is discovered, have the seat belt repaired at a KG Mobility Corporation authorized service center immediately.

- If a strong impact has been applied to the seat belt due to an accident, etc., make sure to have the seat belt checked and replaced with a new one as needed even if there is no abnormality visually. Also check and replace the retractor and the seat belt anchorage if there is an abnormality.
- Care should be taken to prevent the seat belt from being contaminated by polishes, oils, chemicals and especially battery acid. When cleaning, wipe the seat belt carefully using a neutral detergent and water. Replace the seat belt if the webbing is frayed, contaminated or damaged.
- Do not place a hard or sharp object in the clothes or a pocket where comes into contact with the seat belt.
- The seat belt can reduce serious injuries. However, it cannot block fatal accidents and injuries completely. Keep this in mind and drive safely.

Child restraint for an infant or a small child*

For an infant or a small child who cannot wear the three-point seat belt, have the infant or the small child be seated in a rear seat using a child restraint for an infant or a small child whose quality is certified by the government.

If the infant or the small child sits in the front passenger seat, the infant or the small child cannot be protected from an inflated air bag or other impacts in the event of a vehicle collision.



Warning

Seating an infant or a small child

- Do not let an infant or a small child sit in the front passenger seat. Doing so may cause a serious injury or death due to the inflation impact of the front air bag in the event of a collision accident.
- Do not ride with an infant or a small child in your arms or sitting on your lap. Doing so may cause a fatal injury to the infant or the small child in the event of a collision accident.
- If an occupant who is smaller than 140 cm wears the three-point seat belt, the seat belt cannot function fully. In such case, install and use a child restraint that fits the physical condition of the occupant.

Installing the child restraint

- Never use a rearward facing child restraint on a seat Protected by an ACTIVE AIRBAG in front of it, DEATH or SERIOUS INJURY to the CHILD can occur.
- Use a child restraint for an infant or a small child that passed through the certification and the safety inspection carried out by a certified government agency. Follow the manufacturer's owner's manuals for the installation and precautions of the child restraint.
- If the child restraint for an infant or a small child is installed incorrectly, it may not provide the appropriate protection function. In such case, it may result in a serious risk when an accident occurs.
- If the child restraint for an infant or a small child is not secured completely, injury or death of an infant or a small child may occur in the event of a collision accident.
- Never install a rear-facing child restraint in the front seat with front passenger air bag.
- Install the child restraint for an infant or a small child on the left or right side of the rear seat where the three-point seat belt is installed. If it is installed on the front passenger seat, a fatal injury may occur when the air bag inflates.
- When installing the child restraint for an infant or a small child in the rear seat of a vehicle where a curtain air bag is installed, install it as far as possible from the door. Failure to do so may cause serious injury or death of an infant or a small child when the curtain air bag inflates.
- When the child restraint for an infant or a small child is installed on the rear seat where the three-point seat belt is installed, be careful not to position the seat belt across the neck or face of an infant or a small child.

Using the child restraint

- When the child restraint for an infant or a small child is used, observe instructions provided by the manufacturer. Failure to do so may cause a fatal injury when an accident occurs.
- After installing the child restraint for an infant or a small child, make sure to check if it is secured correctly.
- Make sure that the child restraint is secured correctly by pushing or pulling it in various directions before letting an infant or a small child sit in the child restraint.

Managing the child restraint

- Do not carry the child restraint for an infant or a small child in the vehicle without installing or securing it. Doing so may cause the child restraint to bounce, causing an injury to the occupants in the event of sudden braking or an accident.



Caution

- This information is to help in understanding the necessity and usage of the child restraint for an infant or a small child. Use this information for reference purposes.
- When the child restraint for an infant or a small child is used, install and use it according to the owner's manual provided by the manufacturer.

Infant and child safety

Child Seat

Children that are too small to use the seat belts must be properly secured in a child restraint system.

Warning

- Never install a rear-facing child restraint in the front passenger seat with front passenger air bag.
- Because of the danger that an inflating passenger air bag could impact the rear-facing child restraint and kill the child.
- Use only the qualified child restraint systems. Follow the manufacturer's instructions for installation and use of the child restraint systems.
- Do not carry your child on your lap while driving. You cannot resist against the impact pressure in an accident. The child could be crushed between you and the parts of vehicle.
- Remember that a child restraint seat left in a concealed vehicle can cause it to be very hot. Check the seating surface before putting your child in the child restraint.
- When your child restraint is not in use, remove it from the vehicle or keep it secured with a seat belt to prevent it from being thrown forward in case of a sudden stop or an accident.
- When installing a child restraint, do not let the seat belts come across the child's neck.

Table of Vehicle Handbook Information on Child Restraint Systems Installation Suitability for Various Seating Positions



Rear-facing child seat



Forward-facing child seat



TYPE A



TYPE B

Booster seat

Mass group	Restraint device figure	Front seat	Rear center	Rear seat out board	Mounting method of vehicle
O ~ up to 10 kg (0 ~ 9 month)	Rear facing child seat	X	X	U	3-point belt rear-facing
O+ ~ up to 13 kg (0 ~ 2 year)	Rear facing child seat	X	X	U	3-point belt rear-facing
I ~ 9 to 18 kg (9 month ~ 4 year)	Forward facing child seat	X	X	U	3-point belt
II ~ 15 to 25 kg (4 year ~ 12 years)	Booster seat	X	X	U	3-point belt
III ~ 22 to 36 kg (4 year ~ 12 years)	Booster seat	X	X	U	3-point belt

U: Suitable for "universal" category restraints approved for use in the mass group.

UF: Suitable for forward-facing "universal" category restraints approved for use in the mass group.

L: Suitable for particular child restraints given on attached list. These restraints may be of the "semi-universal" categories.

X: Seat position not suitable for children in the mass group.

Installation of crs secured by the seatbelt

Front-facing Child Seat



Secure the child restraint with a seat belt as shown in the figure.

Caution

- When installing a child restraint system, follow the instructions provided by the manufacturer.

Warning

Do not use the car seat unless the followings are met.
The child seat may not perform as intended, which may result in a serious injury.

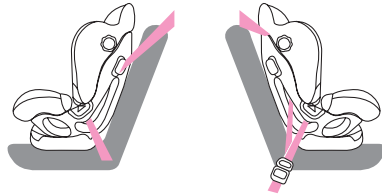

- Make sure that the buckle of the seat belt is securely engaged.
- Make sure that the seat belt is not loose or twisted.
- Make sure that the base does not move due to excessive play in all directions.
- You can't adjust the angle of the backrest with the child seat installed. If you're trying to do so, the seat belt will be slack, which incurs danger. Always adjust the angle of the backrest before installing the child seat.

Rear-facing Child Seat



Secure the child restraint with a seat belt as shown in the figure.

Caution

- Never install a rear facing child restraint on the front seat without ensuring that the front airbag is deactivated. KG Mobility Corporation recommends that a child restraint to be installed on the rear seat.

When installing a child restraint, adjust the seat back angle as desired.

Warning

Do not use the child seat unless the followings are met.

The child seat may not perform as intended, which may result in a serious injury.

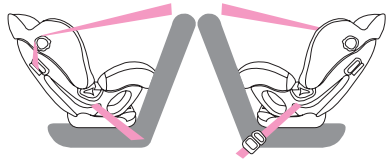

- Make sure that the buckle of the seat belt is securely engaged.
- Make sure that the seat belt is not loose or twisted.
- Check if the angle of the backrest is set to 4 stage.
- Make sure that the base does not move due to excessive play in all directions.
- Make sure that the seat belt is routed through the rear-facing belt path and buckled up.

Securing a child restrain system with “ISOFIX” system

ISOFIX system is a standardized method of fitting child seats that eliminates the need to use the standard adult seatbelt to secure the seat in the vehicle. This enables a much more secure and positive location with the added benefit of easier and quicker installation.

How to use the ISOFIX Lower Latch Anchor

- The ISOFIX lower latch anchors are located in the left and right outboard rear seating positions. Their locations (1) are shown in the illustration.
- Insert the child restraint attachments into the ISOFIX lower latch anchors until it clicks.
- Do not use the seat belt for installing the ISOFIX child restraint.
- There is no ISOFIX lower latch anchor provided for the center rear seating position.

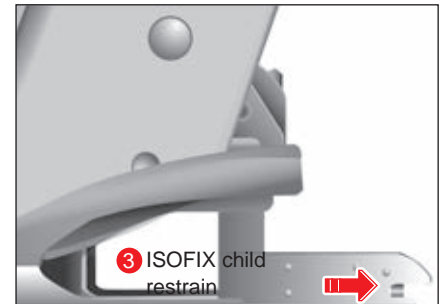



Warning

- When using the “ISOFIX” lower latch system, all unused vehicle rear seat belt metal latch plates or tabs must be latched securely in their seat belt buckles and the seat belt webbing must be retracted behind the child restraint to prevent the child from reaching and taking hold of unretracted seat belts. Unlatched metal latch plates or tabs may allow the child to reach the unretracted seat belts which may result in strangulation and a serious injury or death to the child in the child restraint.
- Child restraint anchorages are designed to withstand only those loads imposed by correctly fitted child restraints. Under no circumstances are they to be used for adult seat belts or harnesses or for attaching other items or equipment to the vehicle.

How to use the Rear Anchor

Two rear anchors are located on the rear wall.

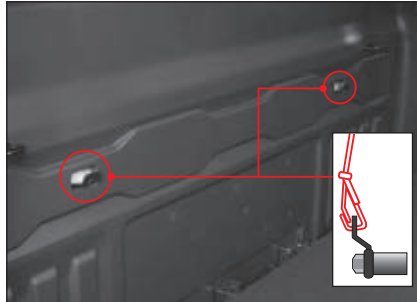
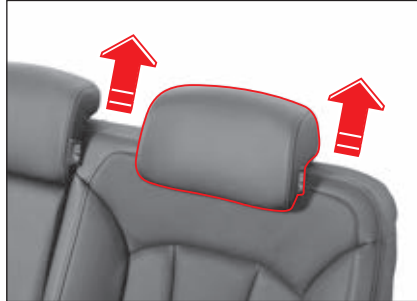

- 1 Remove the headrest from the rear seat.
- 2 Place the child restraint on the rear seat.
- 3 Connect the tether connector in child restraint to the rear anchor. Securely tighten the child restraint by adjusting the webbing of the tether connector.

Cautions for ISOFIX Seat



Caution

- The rear anchor is the supplemental device to secure the child restraint system after engaging it by the lower latches. Therefore, do not secure the child restraint system only with the seatback anchors. The increased load may cause the hooks or anchors to break, causing serious injury or death.
- If a child restraint is not properly secured to the vehicle and a child is not properly restrained in the child restraint, the child could be seriously injured or killed in a collision. Always follow the instructions provided by the manufacturer for installation.
- Make sure the latches of the child restraint system are latched to the lower latches. In this case, you can hear the “click” sound.
- Incorrectly installed child restraint system may cause an unexpected personal injury.
- Child restraint anchorages are designed to withstand only those loads imposed by correctly fitted child restraints.

- The tether strap may not work properly if attached somewhere other than the correct rear anchor.
- Rock the child restraint to check if it is securely installed. Refer to instructions provided by the manufacturer of the child restraint.
- Do not install the child restraint if it hinders the operations of front seat.
- All the procedures described here are to assist you in understanding the child restraint system. Use this as a reference only. When you install a child restraint to your vehicle, observe instructions for installation in the manual provided by the manufacturer.

Table of Vehicle Handbook Information on ISOFIX Child Restraint Systems Installation Suitability for Various ISOFIX Positions

Mass group	Size Class	Fixture	Vehicle ISOFIX Positions		
			1st row Passenger	2nd row center	2nd row out board
CARRYCOT	F	ISO/L1	X	X	X
	G	ISO/L2	X	X	X
GROUP 0 UP TO 10KG	E	ISO/R1	X	X	IL
GROUP 0+ UP TO 13KG	E	ISO/R1	X	X	IL
	D	ISO/R2	X	X	IL
	C	ISO/R3	X	X	IL*
GROUP I 9 TO 18KG	D	ISO/R2	X	X	IL
	C	ISO/R3	X	X	IL*
	B	ISO/F2	X	X	IUF
	B1	ISO/F2X	X	X	IUF
	A	ISO/F3	X	X	IUF

NOTE: Key of letters be inserted in the above table

IUF: Suitable for ISOFIX forward child restraints systems of universal category approved for use in this mass group.

IL: Suitable for particular ISOFIX child restraint systems (CRS) given in attached list.

These ISOFIX CRS are those of the "specific vehicle", "restricted" or "semi-universal" categories.

X: ISOFIX position not suitable ISOFIX child restraint systems in this mass group and/or this size class.

*R3: 1st row seatback shall be adjusted to 18° of torso angle (-5°)

List of suitable universal Child Restraint Systems (CRS)

Please read carefully the installation manual of your child restraint

Mass group		Child Restraint	Features
0	< 10 kg	-	-
0+	< 13 kg	Maxi Cosi CabrioFix	Belted Rearward facing
I	9 to 18 kg	Römer King II LS	Belted Forward facing
II	15 to 25 kg	Römer KidFix XP	Belted Forward facing
III	22 to 36 kg	Römer KidFix XP	Belted Forward facing

List of suitable ISOFIX Child Restraint Systems (CRS)

Please read carefully the installation manual of your child restraint

Mass group		Child Restraint	Features
0	< 10 kg	-	-
0+	< 13 kg	-	-
I	9 to 18 kg	Römer Duo+	ISOFIX & Top Tether Forward facing
II	15 to 25 kg	Römer KidFix XP	ISOFIX & Belt Forward facing
III	22 to 36 kg	Römer KidFix XP	ISOFIX & Belt Forward facing

Warning For Child Restraint

- Group II & III**
 Booster seat fitted on the rear seat with seat belt fastened Always follow the installation and use instructions provided by the manufacturer of the booster seat.
- Use only the officially approved child restraint.**
 KG Mobility is not responsible for the personal injury and property damage due to the defect of child restraint.
- Use only the child restraint with proper type and size for your baby.**
- Use only the child restraint at proper location.**
- Child restraint has 5 categories based on the weight as below:**
 GROUP 0: 0 ~ 10KG
 GROUP 0+: 0 ~ 13KG
 GROUP I: 9 ~ 18KG
 GROUP II: 15 ~ 25KG
 GROUP III: 22 ~ 36KG
- Group 0 & 0+**
 Rear facing child restraint fitted on the rear seat
- Group I**
 Forward facing child restraint fitted on the rear seat
- Group II & III**
 Booster seat fitted on the rear seat with seat belt fastened
 Always follow the installation and use instructions provided by the manufacturer of the booster seat.



Warning

- Rock the belt to see if the ISOFIX child restraint belt hook is fixed to the backrest anchor firmly.**
- Do not use the ISOFIX child restraint only fixed to the backrest anchor without fixing it to the lower latch. If the anchor is damaged due to an increase in the load applied to the anchor, a risk to life or a serious injury may occur.**

Air bag*

The air bag is an ancillary safety unit that inflates instantaneously in the event of a vehicle collision, protecting an occupant from the impact.

The air bag system is composed of the air bag crash sensor, air bag control module and air bag.

The air bag operates according to various factors including the strength and direction of a vehicle collision, strength of a colliding object, vehicle speed and the condition of the occupant.

Warning

- The air bag is an auxiliary unit that supplements the protection function of the seat belt and it cannot replace the seat belt. The seat belt should be fastened during driving.
- The air bag includes electric sensors and control modules and it only operates when the ignition switch is in the On position or the engine is running.
- The air bag is installed on the part where “AIRBAG” is displayed. Do not apply an impact to, place an article on or attach an accessory to the part where the air bag is installed. Doing so may cause a serious injury when the air bag inflates.
- When 10 years have passed after the air bag is installed, make sure to have the air bag checked at a KG Mobility Corporation authorized service center even if there is no abnormality in the air bag system visually.

Air bag warning label

The air bag warning label displaying the risk of secondary damages in case the air bag inflates and safety information is attached to the passenger side sun visor. Read and familiarize yourself with the safety information before driving.



Warning

- The air bag is a unit that explodes a type of gunpowder in the unit and inflates the air bag instantaneously to protect the occupant. Therefore, noise, glare and smoke occur due to the explosion of gunpowder when the air bag inflates.
- The occupant may get burned when the air bag inflates. In some cases, the occupant may suffer injuries such as a bruise, bone fracture, abrasion and facial blows due to the inflated air bag and secondary damages such as broken glass.

Air bag warning lamp

The air bag warning lamp turns on when the ignition switch is turned On, and it turns off when there is no abnormality in the air bag system.



Warning

- If the air bag warning lamp stays on continuously, it indicates that there is abnormality in the air bag or the seat belt pretensioner system. Have your vehicle checked and serviced at a KG Mobility Corporation authorized service center immediately.

Air bag crash sensor and air bag control module

The vehicle is equipped with sensors that can detect a collision and a module that controls the air bag operation.



- ① Air bag control module
- ② Front impact sensor (G-sensor type)
- ③ Side impact sensor (G-sensor type)

Configuration of air bag

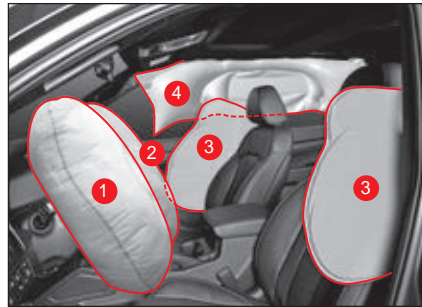

- ① Driver air bag
- ② Front passenger air bag
- ③ Front seat side air bag
- ④ Curtain air bag

Passenger Air Bag ON/OFF Switch



The front passenger air bag is disabled (not inflatable) when placing the passenger air bag ON/OFF switch to "OFF" position. This switch is located on the right side of the instrument panel, and you can see it when opening the front passenger door. Press and turn this switch to operate.

"OFF" position: disabled (not inflatable)

"ON" position: enabled (inflatable)

Driver air bag

The driver air bag protects the driver's head in the event of a front collision.

The driver air bag is installed in the center of the steering wheel.



Warning

- The driver should sit as far as possible from the steering wheel within the range that it does not hinder the driver from controlling the vehicle. If the driver sits too close to the steering wheel, a fatal injury may occur when the air bag inflates.
- Do not place any object on or attach an accessory or a sticker to the air bag cover (steering wheel cover). Doing so may hinder the air bag from operating normally and increase a risk of injury when the air bag inflates.

Front passenger air bag

The front passenger air bag protects the front passenger's head in the event of a front collision.

The front passenger air bag is installed inside of the dashboard in front of the front passenger seat.



Warning

- Sit as far as possible from the dashboard where the front passenger air bag is installed. If the front passenger sits too close to the dashboard, a fatal injury may occur when the air bag inflates.

Notice

- The front passenger air bag operates along with the driver air bag at the same time.

Front seat side air bag

The front seat side air bag protects the side of the front seat occupant in the event of a side collision that meets the condition for inflating the air bag.

The front seat side air bag is mounted in the side of the driver seat backrest and the front passenger seat backrest.



Warning

- Do not hang clothes or accessories or use seat covers on the seats where the side air bag is mounted.
- Do not apply impact to the area where the collision detection sensor for the side air bag (front seat backrest) is installed. Doing so may cause the side air bag to malfunction.

Curtain air bag

The curtain air bag protects the head of the front seat occupants and the rear seat occupants in the event of a side collision that meets the condition for inflating the air bag.

The curtain air bag is mounted on the roof at the top of the front and rear doors on both sides.



Warning

- Do not apply impact to the curtain air bag crash sensor (bottom part of the B pillar). Doing so may cause the curtain air bag to malfunction.
- Do not slam the door. Doing so may cause the air bag to malfunction.

Notice

- The side air bags and the curtain air bags operate at the same time in the event of a side collision, but the left and right side air bags and curtain air bags operate separately.

Cases where the air bag does not inflate

The air bag does not inflate in all collision accidents. The air bag may not inflate, in any of the following cases:

In the event of a slight collision

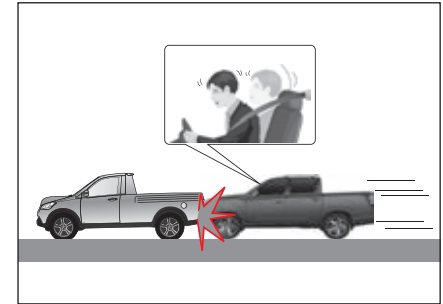

The air bag may not inflate in the event of a slight collision that the collision detection sensor cannot detect or the strength of collision is weak.

In such case, the seat belt can provide enough protection and the air bag operation may instead give secondary damages to the occupant such as a burn or an injury.

In the event of a rear end collision

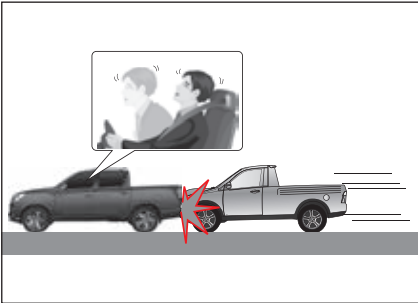

In the event of a rear end collision by another vehicle, the body of the occupants move backwards, so the air bag cannot provide enough protection even if it inflates. In such case, the air bag may not inflate.

In the event of a side collision

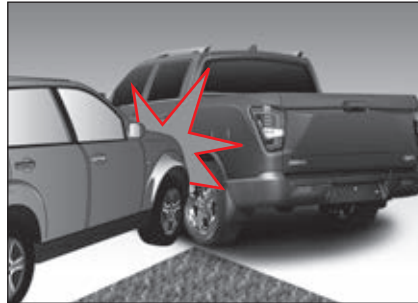

In the event of a side collision, the occupants cannot be protected by the front air bags, so the front air bags may not inflate. However, the curtain air bags and the side air bags operate depending on the degree of impact in the event of a side collision, protecting the front seat occupants.

In the event of a diagonal collision

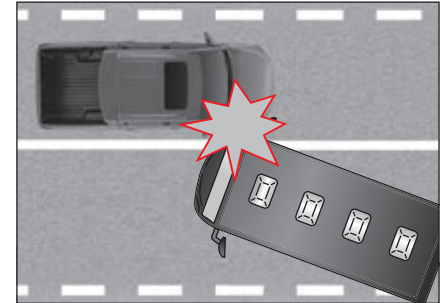

Since the impact of a collision in the diagonal direction is weaker than the impact of a collision in the front or side direction, the air bag may not inflate.

In the event of a collision with a narrow object



In the event of a collision with a narrow object such as a street light, utility pole or tree, the degree of impact applied to the sensor may not be enough, so the air bag may not inflate.

In case the vehicle moves beneath another vehicle

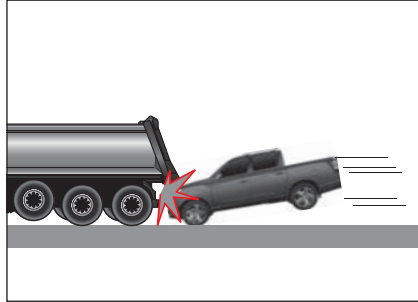

Generally, most drivers apply a sudden brake when an accident occurs, so the front part of the vehicle becomes lower. Therefore, the vehicle often moves beneath the opposing vehicle in the event of an accident against a tall vehicle such as a bus or a truck. In such case, the air bag may not inflate.

In the event of a rollover accident

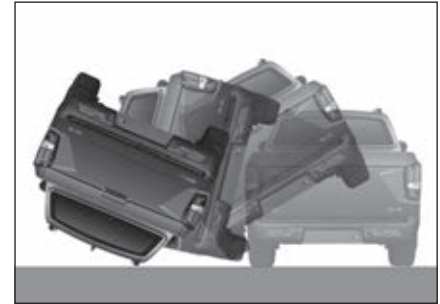

If the vehicle turns over or rolls over, the occupant cannot be protected fully by the air bag alone. In such case, the air bag may not inflate. However, the curtain air bag or the side air bag may inflate according to the degree of impact applied to the side when the vehicle turns over.

Secondary injury due to air bag deployment



If the air bag control module detects the impact during an accident, it transmits the signal to deploy the air bag. This signal triggers the explosion of the powder, which is included in the air bag module, and the air bag deploys in a very short time to protect the occupants. When the air bag inflates, there will be heavy noise, glare and smoke. You could suffer secondary injuries caused by inflated air bag such as an abrasion, a bruise, a burn or injury by broken glasses.

Other cases



Cases where the driver/front passenger air bags do not inflate

- When the air bag warning lamp is on
- When an impact is applied to the top of the engine hood by a falling rock, etc.
- When the vehicle falls into a drainage ditch or a puddle

Cases where the side air bags or curtain air bags do not inflate

- When the air bag warning lamp is on
- In case of a front or rear collision
- When the vehicle rolls over or turns over in the side direction with a moderate degree of impact

Warnings for the air bag

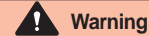

Warning

Seating an infant or a small child

- Do not let an infant or a small child sit in the front passenger seat or ride with an infant or a small child in your arms. The infant or the small child and you may get seriously injured or killed when the air bag inflates.
- Do not install a child restraint for an infant or a small child in the front passenger seat. If the air bag inflates, the infant or the small child may get seriously injured or killed due to the impact.
- When installing the child restraint for an infant or a small child in the rear seat of a vehicle where the curtain air bag is installed, install it as far as possible from the door. Failure to do so may cause serious injury or death of an infant or a small child when the curtain air bag inflates.

Driving and riding position

- Only hold the rim of the steering wheel when driving. Doing so ensures that the air bag inflates fully when it operates.
- Do not lean against the steering wheel or maintain your arms in an “X” shape. You may get seriously injured when there is a problem in the air bag operation or the air bag inflates.
- Do not drive while leaning forward or come too close to the steering wheel. You may get hit by the air bag and seriously injured on your head and neck or even killed before it inflates fully.
- If you wear the seat belt in an unstable position or while leaning to one side, the air bag cannot provide enough protection. You may even get seriously injured by the air bag.
- Do not place your foot or hands on the dashboard. You may get seriously injured when the air bag inflates.
- Do not lean against the door or stick your arm out of the window. You may get seriously injured when the curtain air bag inflates.

Handling the air bag

- Do not apply impact to air bag-related devices including the steering wheel, the part where the air bag is installed, wires and the seat belt pretensioner system. You may get seriously injured when the air bag inflates suddenly.
- Do not apply impact to the seat backrest where the side air bag is installed. Doing so may cause the side air bag to malfunction.
- Do not slam the door when closing the door. Doing so may cause the curtain air bag or the front air bag to malfunction.
- Do not place any object between the air bag and the occupant. Doing so may hinder the operation of the air bag and you may get injured by such an object when the air bag inflates.
- After the air bag and the seat belt pretensioner operate, their relevant components become very hot. Never touch such components until they have cooled down.

Operation of the air bag

- The air bag is a unit that protects the life of a passenger from a sudden accident, and it inflates at high speed by hot gas. The occupant may suffer injuries such as a burn, abrasion or bruise according to the circumstances at the time when the air bag inflates.
- A loud noise, dust, smoke or gas that occurs when the air bag or the seat belt pretensioner operates is normal.
- Gas generated when the air bag or the seat belt pretensioner operates is nontoxic, but if your skin, eyes or nose becomes irritated, wash with clean water. If the symptom persists, consult your doctor.
- Caution should be taken that the windshield or window glasses may be broken due to an impact from the operation of the front seat air bag or curtain air bag.

Do not modify the air bag or change the structure

- Do not modify or change the structure of any air bag-related devices including the steering wheel, the part where the air bag is installed or the wires. Do not check an air bag-related circuit with a tester. Doing so may cause the air bag system to malfunction or break down, resulting in personal injury and property damage.
- Do not replace the steering wheel with a product which is not a KG Mobility Corporation genuine part. Doing so may cause the air bag in the steering wheel not to operate normally.

Tire pressure monitoring system (TPMS)*

The tire pressure monitoring system (TPMS) is an auxiliary safety unit that detects if the tire pressure is abnormally high or low and informs such fact to the driver, preventing an accident that may occur due to the tire pressure.

- The global warning light (⚠) comes on if the tire pressure is abnormal.
- Also, if there is abnormality in the tire pressure monitoring system (including the sensor), the global warning light (⚠) blinks and stays on.

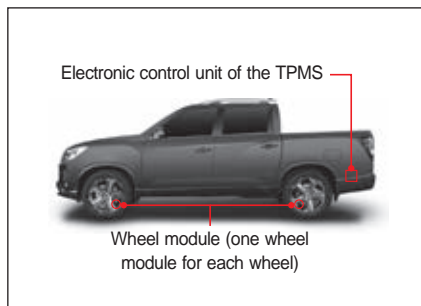

The electronic control unit of the TPMS receives various data including the tire pressure and temperature from the wheel module mounted on each wheel and displays such data on the instrument cluster.

- Proper tire pressure: 34 psi, 2.35 bar
- The proper tire pressure is the value measured at room temperature (20 °C) in the condition of an empty vehicle when the tires have been cooled properly.

Notice

- **If the vehicle is driven at a speed of 30 km/h or faster after the engine is started, the tire pressure is detected within 5 minutes although it might be slightly different depending on the system status. If the tire pressure is not sensed, “-” will be displayed.**



Caution

- **The tire pressure displayed on the display of the instrument cluster can be changed by various environmental factors including the driving status of the vehicle, number of occupants in the vehicle and the status of air injection into the tires.**
- **When air is injected into a tire, airs with different temperature are mixed, so the tire pressure may be changed until a temperature balance is reached.**

Checking the tire pressure

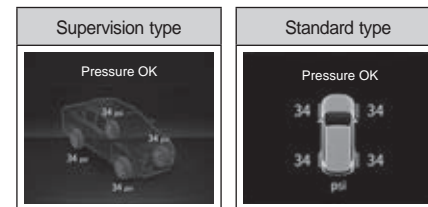

By selecting TPMS status from the main menu of the instrument cluster, you can check all tire pressures from the display of the instrument cluster.

If the tire pressure or the TPMS is abnormal



If the tire pressure or the tire pressure monitoring system is abnormal, the global warning light blinks or comes on.

- Abnormal tire pressure (low/high/flat): The global warning light stays on.
- Abnormal tire pressure monitoring system (including the sensor): The global warning light blinks for approximately 70 seconds and stays on.







Warning





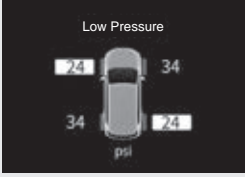

- If the global warning light comes on in the instrument cluster, the tire pressure is insufficient, excessive or uneven. Make sure to park your vehicle at a safe place and check the tire pressure.
- If the global warning light stays on after checking the tire pressures, starting the engine and driving the vehicle for more than 10 minutes at a speed over 30 km/h, have your vehicle checked and serviced at a KG Mobility Corporation authorized service center.
- A sudden tire damage due to an external factor such as a nail or a road debris, etc. may not be detected immediately. If the vehicle becomes unstable while driving, slow down, move the vehicle to a safe place and check the vehicle.
- Do not modify or remodel your vehicle in a way that hinders the operation of the TPMS.
- For safety, always use genuine wheels equipped with the tire pressure monitoring sensor.

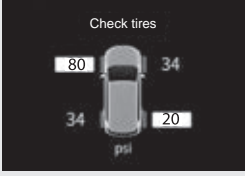
Caution

- Adjust the tire pressure when the tires are cold (no driving for 2 or 3 hours).
- Even if the tire pressure has been adjusted to a proper tire pressure, the global warning light () may come on due to a difference in the internal tire temperature and air temperature. This is the phenomenon that the tire pressure drops in proportion to the temperature and this does not indicate that the TPMS is abnormal.
- If you need to drive while the ambient temperature rises or drops rapidly, check and adjust your tire pressure to the prescribed inflation pressure in advance before driving.
- For safe driving, check your tire pressure regularly without simply depending on the TPMS.

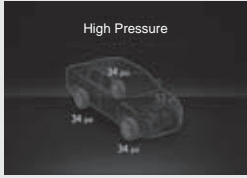
Display of the TPMS status on the instrument cluster

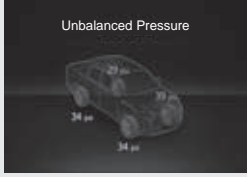
Item	Supervision type	Standard type	Operating condition
Tire pressure OK			<ul style="list-style-type: none"> It is displayed when the tire pressure is normal.
Low pressure			<ul style="list-style-type: none"> In order to detect whether the tire pressure is normal or insufficient, the TPMS wheel module must be properly installed on each wheel. After IGN ON, it takes several seconds for the TPMS ECU and TPMS wheel module to communicate normally, and during this time, each state is displayed.
			<ul style="list-style-type: none"> It is displayed when the tire pressure is too low and that it needs to be checked. The pressure figure of the relevant tire is inversely shaded and the global warning light comes on.
Check tires			<ul style="list-style-type: none"> It is displayed when the tire pressure is too low to require checking the tire. The corresponding tire's pressure value display area is shaded and the global warning light turns on.

Item	Supervision type	Standard type	Operating condition
Flat tire			<ul style="list-style-type: none"> It is displayed when the tire pressure decreases rapidly or a tire is flat. The pressure figure of the relevant tire is inversely shaded and the global warning light comes on.
High pressure			<ul style="list-style-type: none"> It is displayed when the tire pressure is too high. The pressure figure of the relevant tire is inversely shaded and blinks.
Pressure imbalance			<ul style="list-style-type: none"> If a difference between left and right tire pressures is 5 psi or more, the pressure figure of the relevant tire is inversely shaded and blinks.

Notice	<p>If a certain tire pressure is shown as “—” while the other tire pressures are shown normally, the TPMS wheel module of the relevant tire may be abnormal. Have your vehicle checked and serviced at a KG Mobility Corporation authorized service center immediately.</p>
---------------	---

When low tire pressure is detected

When a tire with significantly low pressure is detected, the global warning light () comes on and the position of the relevant tire with low pressure is indicated on the instrument cluster.

In such case, slow down, bring your vehicle to a KG Mobility Corporation authorized service center and have your vehicle checked and serviced.



Caution

- If you drive the vehicle continuously with a low tire pressure, the life of the tires, vehicle operating force, brake force and vehicle fuel efficiency may decrease.
- If you cannot bring your vehicle to a KG Mobility Corporation authorized service center, add air to the tire using the service kit for tire repair.
☞ Refer to "Inflating a tire" (p.5-15)

When you have rotated the tires

When you have rotated the tires, the TPMS resets the position of each tire.

If the vehicle is driven at a speed of 30 km/h or faster, typically the system completes the reset within 5 minutes although it might be slightly different depending on the system status.

☞ Refer to "Rotating the tire positions" (p.6-52)



Warning

- If you replace a tire where sealant has been injected for repairing the tire, be sure to have the exterior of the TPMS sensor and the TPMS checked for normal operation at a KG Mobility Corporation authorized service center.



Caution

- If you rotated the tires or replaced a wheel module including the tire pressure detection sensor, the tire position may not be recognized correctly at the beginning of driving so that the previous tire pressure may be displayed or the global warning light () may turn on. This is a temporary state which is not a failure.
- The time taken for resetting the tire position may vary depending on the driving condition of the vehicle.

Cautions for the TPMS



Caution

- If a wheel without a wheel module (tire pressure detection sensor) is installed to the vehicle, the global warning light turns on and the TPMS does not operate.
 - Do not rely too much on the TPMS and be sure to check the tire pressure status before driving the vehicle.
 - The TPMS operates in a way that it communicates with the wheel module by wireless. Therefore, if an electronic device such as a mobile speed camera detector that can create radio interference is installed to the vehicle, the TPMS may not operate normally.
 - In an area with a strong electromagnetic field (police stations, government offices, broadcasting stations, military facilities, transmitting towers, etc.), the TPMS may fail and the global warning light (⚠) may turn on.
 - If any foreign object is caught in the transmitter attached to the tire wheels while driving on a muddy or snowy road, hindering the communication with the receiver of the vehicle, the radio interference occurs due to strong external waves or a metal object is located near the TPMS, the tire pressure may be displayed with a time delay or may not be displayed normally.
- When you drive the vehicle with snow chains installed, the snow chains may hinder the communication between the wheel module and the antenna so that the TPMS may not operate normally. However, this does not impair the operation of the vehicle.
 - When air is injected into a tire, the tire pressure displayed on the air injection device may be different from the tire pressure displayed on the TPMS. This difference is caused by factors including the driving status of the vehicle, number of occupants in the vehicle and the status of air injection into the tire and this does not indicate the failure of the TPMS.
 - Be careful not to damage the wheel module when the tires are replaced. If the wheel module receives an impact or is damaged when the tires are replaced, the tire pressure detection function does not operate.
 - If you have your tires replaced at a tire shop other than a KG Mobility Corporation authorized service center, be sure to inform that the TPMS has been fitted to the tires.
 - The life of the battery in the tire pressure detection sensor (wheel module) may be reduced if abnormalities such as checking tire pressure, low pressure, high pressure and pressure imbalance occur frequently.

Anti-theft and warning system

Immobilizer system

The immobilizer system is a vehicle anti-theft system that prevents it from starting the engine unless a permitted key is used.

The engine can be started only when the code of the transponder integrated in the smart key has been authenticated by comparing it with the code of the engine control unit.



Caution

- **The immobilizer system cannot be removed from the vehicle under any circumstance. If you arbitrarily remove or damage the immobilizer system, you cannot start the engine. Never remove, damage or modify the immobilizer system.**
- **The immobilizer system should be repaired only by a licensed technician at a KG Mobility Corporation authorized service center.**
- **When the code of the transponder is deleted or an additional key is registered, observe the process in person.**
- **Do not install a metallic accessory near the smart key or the ignition switch. Such accessory changes the signal delivered to the ignition switch, preventing it from starting the engine.**
- **Do not drop the smart key or apply impact to it. Doing so may damage the transponder.**
- **Do not modify the vehicle arbitrarily to install a remote starting device. Doing so may cause a problem in starting the engine or a fatal accident.**

Immobilizer/smart key warning light

If the immobilizer or the smart key system is abnormal, the immobilizer/smart key warning light will blink.

Supervision type



Notice

- **The communication time between the immobilizer/smart key and the engine control unit may vary according to circumstances. If such time is short, the warning light may not turn on.**

If the engine does not start

You cannot start the engine if there is a communication error between the immobilizer/smart key and the engine control unit due to an internal system error or an external communication failure factor.

In such case, the immobilizer warning light will blink.

You may not be able to start the engine in a vehicle with the immobilizer system, in any of the following cases:

- When two or more smart keys come into contact with each other are used
- When the smart keys is used near a device that sends or receives electromagnetic fields or waves
- When the smart keys is used near electric or electronic devices such as lighting equipment, security keys or security cards
- When the smart keys is used near a key chain, a magnet, a metallic object or a battery
- When you start the engine before the engine preheating time ends

Caution

- **You may not be able to start the engine due to an external factor (key chain, magnet, etc.) or early starting before the engine preheating time to cause communication failure with the immobilizer. In such case, eliminate the factor preventing it from starting the engine, place the smart key outside the operation range of the antenna for approximately 10 seconds or longer and start the engine again.**
- **If the immobilizer/smart key warning light blinks continuously and you still cannot start the engine after eliminating the external factor, have your vehicle checked and serviced at a KG Mobility authorized service center.**

When the transponder is damaged

You can't start the engine with a key whose transponder is damaged. In such case, replace the smart key with a new one and register the relevant code on the engine control unit.

When you lose the key

When you lose your key, the transponder code of the lost key registered on the engine control unit should be deleted.

Have KG Mobility authorized service centers take measures for preventing vehicle theft by a lost key.

Theft deterrent system

The theft deterrent system activates the theft alarm when the door, tailgate or engine hood is opened in another way without unlocking the vehicle using the remote key or smart key, preventing the vehicle from theft.

Entering the theft monitoring mode

When the door lock button (including the door lock/unlock button on the exterior of the front doors) of the remote key or smart key is pressed with all doors and engine hood closed, the system enters the theft monitoring mode.

- When the system enters the theft monitoring mode, the warning light blinkstwice and the warning buzzer sounds once.
- **Remote control key:** When the theft deterrent system is armed, the hazard flashers blink twice. However, if you press this button once again in 4 seconds, the hazard flashers blink twice and the buzzer sound once.
- **Smart key:** When the theft deterrent system is armed, the hazard flashers blink twice and the buzzer sound once.
- If approximately 30 seconds have passed without opening the door after unlocking the door using the remote key or smart key in the theft monitoring mode, all doors are locked again and the system enters theft monitoring mode.



Caution

- **If you insert the key into the door key hole and lock the doors, only the doors are locked but the theft deterrent system is not activated.**
- **The system enters the theft monitoring mode only when the ignition switch is on Off and all doors and engine hood are closed completely.**
- **If the ignition switch is on Acc or On or the engine is being started, the system does not enter the theft monitoring mode.**

Activating the theft alarm

In the theft monitoring mode, the warning light and the warning buzzer operate at an interval of 1 second for 30 seconds in any of the following cases:

- When an attempt to open the door, tailgate or engine hood without using the smart key is made
- When the key is inserted into the key hole to open the door
- When the door lock lever is placed in the unlock position forcibly

When the theft deterrent system is activated, the alarm stops in any of the following cases: However, the theft monitoring mode is maintained at this time.

- When the door lock button or door unlock button on the smart key is pressed
- When the door lock/unlock button on the exterior of the front door is pressed
- When the ignition switch is On
- **Remote control key:** pressing “Lock”, “Unlock”, “Panic” button on the remote control key, or turning the ignition switch to “ON” position
- **Smart key:** pressing “Lock” or “Unlock” button on the Smart key, pressing the “Lock/Unlock” button on the outside door handle, or turning the ignition switch to “ON” mode by pressing it.

Canceling the theft monitoring mode

The theft monitoring mode is canceled when the door is switched to the Unlock position using the remote key or smart key (including the door lock/unlock button on the exterior of the front doors).

Notice

- When the theft monitoring mode is canceled, the warning light blinks once and the warning buzzer sounds twice.
 - All doors are locked again and the system enters theft monitoring mode, when approximately 30 seconds have passed without opening the door after unlocking the door using the smart key in the theft monitoring mode.
-
- **Remote control key:** When the theft deterrent system is disarmed, the hazard flashers blink once.
 - **Smart key:** When the theft deterrent system is disarmed, the hazard flashers blink once and the buzzer sound twice.

3. Convenient Equipment

You can check information regarding devices that allow you to drive the vehicle conveniently and wisely and how to use such devices.

An explanation is provided for doors, seats, windows as well as various convenient equipment including the tailgate, various lights and lamps, mirrors, heater and air conditioner, AV/navigation, storage and cargo box.

Locking, unlocking and opening the door

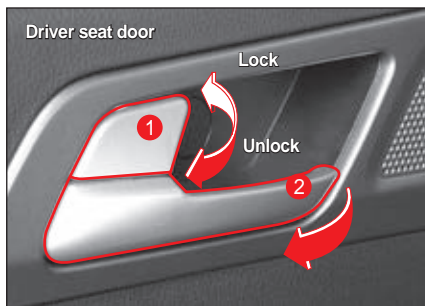

- 1 Door lock/unlock lever
- 2 Door open lever

Door lock/unlock lever

- When you push the driver seat door lock/unlock lever (1) in the lock direction, all doors and the tailgate become locked.
- When you pull the driver seat door lock/unlock lever (1) in the unlock direction, all doors and the tailgate are unlocked.

- When you push or pull the rear seat door lock/unlock lever (1), only the relevant door is locked or unlocked.

Caution

- You cannot lock the door using the door lock/unlock lever or the smart key when the door is opened even slightly.

Door open lever

- If you pull the door open lever (2) when the door is locked, the door is unlocked and opened.
- If you pull the door open lever (2) when the door is unlocked, the door is opened.

Warning

- Be careful not to pull the door open lever to open the door while driving. If the door is opened while driving, you may face a serious risk.

Door Lock/Unlock button

Each time the door Lock/Unlock button on the driver seat is pressed, the status of all doors and the tailgate is changed between locked and unlocked alternately.



Caution

- You cannot lock the door using the door Lock/Unlock button or the smart key when the door is opened even slightly.
- You cannot unlock the door with the driver door Lock/Unlock button in theft monitoring mode.





Warning

- Before driving the vehicle, lock all doors from the driver seat using the door lock/unlock lever. Be sure to drive the vehicle with all doors locked when a child is present in the vehicle. If the door is opened suddenly while driving, you may face a serious risk.
- Before you get out of the vehicle, check the rear and front sides of the vehicle first to see if there is any vehicle, motor cycle, bicycle or person passing by. In particular, opening the door without checking the rear side may lead to an accident.

Auto door lock function at the time of driving

When you drive the vehicle at a speed higher than the set speed with the doors unlocked, all doors and the tailgate are locked automatically.

Notice

- **Supervision type**
You can set at **Vehicle setting** → **Door / Tailgate** → **Auto lock** under  (user settings) in the instrument cluster.
- **Standard type**
You can set at **Door / Tailgate** → **Auto lock** under  (user settings) in the instrument cluster.

Auto door unlock function at the time of collision

When a collision accident occurs with all doors locked and the air bag is activated, all doors are unlocked automatically.



Warning

- If the vehicle body or a door has been deformed due to an impact from an accident, the auto door unlock function may not operate normally.

Child safety door lock

The child safety door lock is installed in order to prevent a child from opening the door in the vehicle when a child is present in the rear seats. The child safety door lock is provided at the inner side of the rear seat doors.



Locking/unlocking the door lock

When the child safety door lock is locked, the rear seat doors cannot be opened with the door open lever in the vehicle even if the rear seat doors are unlocked. In such case, the rear seat doors can be opened only from the outside of the vehicle.

Locking the child safety door lock

Place the child safety door lock lever in the lock position by turning it counterclockwise.

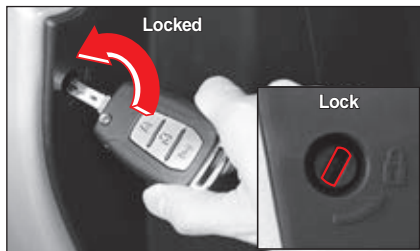

Unlocking the child safety door lock

Place the child safety door lock lever in the unlock position by turning it clockwise.



Warning

- When a child is present in the vehicle, place the child safety door lock lever in the lock position to prevent the child from opening the door in the vehicle.

Configuration

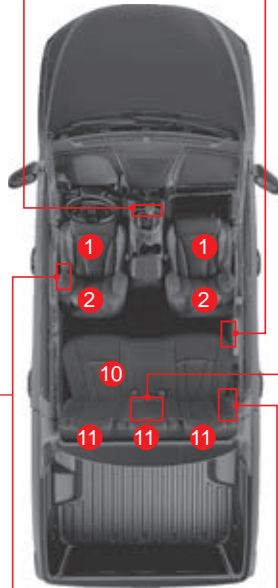
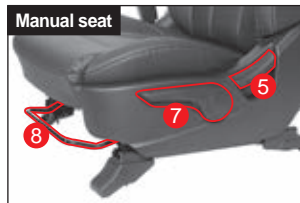
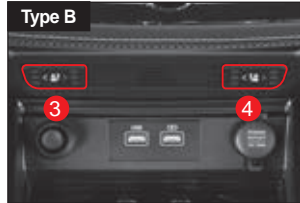

Front seat

- 1 Front seat
- 2 Sliding head restraint
- 3 Driver seat heating/ventilation switch
- 4 Passenger seat heating/ventilation switch
- 5 Seatback reclining adjustment
- 6 Seat cushion tilt adjustment (driver seat)
- 7 Seat height adjustment (for driver)
- 8 Seat slide adjustment
- 9 Lumbar support (for driver)

Rear Seat

- 10 Rear seat
- 11 Head restraint
- 12 Rear seat heating switch
- 13 Armrest (Cup holder)
- 14 Seatback folding lever

Front seat

Adjusting the headrest

Adjusting the front and rear angles

- Push the rear section of the headrest (1) in the arrow direction. The angle of the headrest can be adjusted in 3 levels.
- To return the headrest to its original position, push it to the end in the arrow direction again and release it.

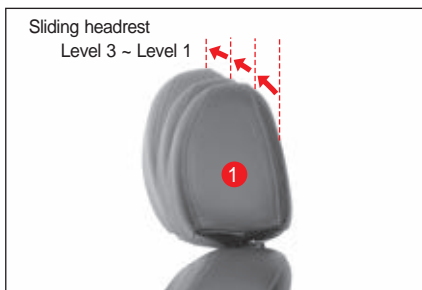

Adjusting the height

- To raise the headrest, hold and pull the headrest up.
- To lower the headrest, push the headrest down with the Lock button (1) pressed in the arrow direction.



Notice

- **Adjust the height of the headrest so that the center of the headrest is aligned with the occupant's eye level.**
- **It may not be possible to align the center of the headrest with the occupant's eye level due to the occupant's physical condition. In such case, align the height of the headrest with the highest position for a tall person and the lowest position for a short person.**

Separation/installation

Separating the headrest

- 1 Recline the seat backrest to secure necessary space for separating the headrest safely.
- 2 With the Lock button (1) pressed in the arrow direction, separate the headrest by lifting it to the end.



- 3 Return the seat backrest to its original position.

Warning

- Never drive the vehicle with the headrest separated. Doing so may cause head, neck or spine injury.

Installing the headrest

- 1 Recline the seat backrest to secure necessary space for installing the headrest safely.
- 2 Insert the headrest into the groove of the seat backrest.
- 3 With the Lock button (1) pressed in the arrow direction, pull down the headrest to the desired position.
- 4 Return the seat backrest to its original position.

Adjusting the power seat*

Front and rear position adjustment (driver seat/front passenger seat)

Set the seat to the desired position by pulling or pushing the front and rear position adjustment lever.



Adjusting the height (driver seat/front passenger seat)

Set the desired height by raising or lowering the height adjustment lever.



Adjusting the cushion angle (driver seat)

Set the desired angle by raising or lowering the cushion angle adjustment lever.



Adjusting the backrest angle (driver seat/front passenger seat)

Set the desired angle by pulling or pushing the backrest angle adjustment lever.



Warning

- Adjust the seat backrest to be upright as possible to maintain a comfortable position. Reclining the seat backrest excessively may cause the occupant to slip down below the seat belt in the event of a vehicle collision or sudden stopping. In such case, the occupant cannot be protected by the seat belt and the air bag, so the occupant may receive a serious injury or lose his/her life.

Adjusting the lumbar support (driver seat)

Set the lumbar support to the desired position by pressing the Lumbar support adjustment button.

- When you press the Forward/Backward adjustment button (1 / 2), the lumbar support is extended or retracted.

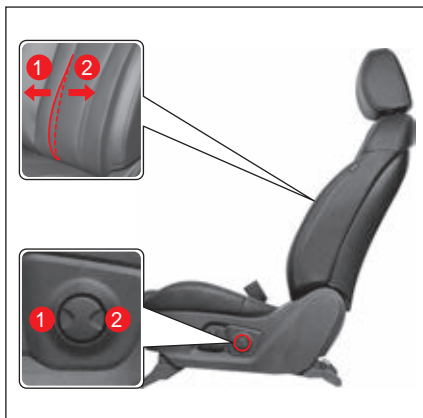

Warning

- Never adjust the seat while driving. If the seat moves suddenly, it may lead to a dangerous situation.
- After adjusting the seat, check that the seat is secured firmly.
- If there is an occupant in the rear seat, adjust the seat while paying attention to the safety of the occupant.
- If the power seat does not operate, drive the vehicle after checking and taking measures.

Caution

- Operating the power seat excessively may damage the electric devices. Use it only for adjusting the seat.
- Operating a number of seat adjustment switches at the same time may damage the motor. Be sure to finish using one function before using another function.
- The power seat operates even when the START/STOP switch is in the OFF status. However, caution should be taken that operating the power seat too frequently when the engine is turned off may cause depletion of the battery.
- If the height of the seat and headrest is high with the front seats pulled forward, be careful when folding the seat backrest forward. Failure to do so may cause the front seats, headrest, sun visor and other components to bump against each other, causing damage.
- If the power seat comes into contact with an object so that it does not move or operate, do not operate it forcibly. Operate it again after eliminating the cause. If there is abnormality, have your vehicle checked and serviced at a KG Mobility Corporation authorized service center.

Adjusting the front passenger seat manually

Adjusting the front and rear positions

With the front and rear position adjustment lever pulled up, set the seat to the desired position by pulling or pushing the seat.

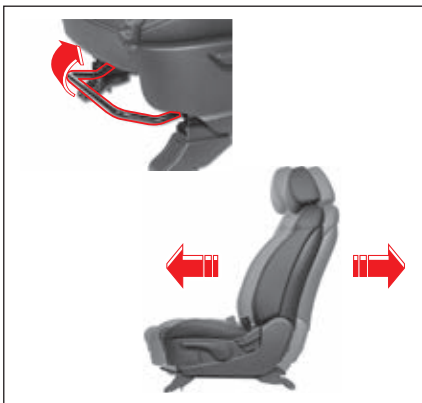

Adjusting the angle of the backrest

With the backrest angle control lever pulled up, move and set the backrest at the desired angle.

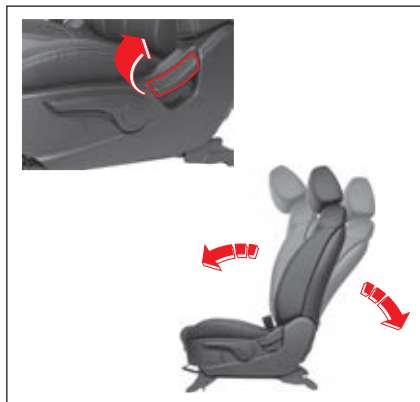

Seat height adjustment (Driver)

To lower the seat cushion, push the lever down several times.

To raise the seat cushion, pull the lever up several times.

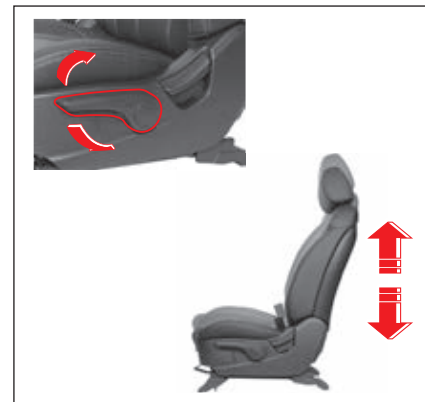

Warning

- Adjust the seat backrest to be upright as possible to maintain a comfortable position. Reclining the seat backrest excessively may cause the occupant to slip down below the seat belt in the event of a vehicle collision or sudden stopping. In such case, the occupant cannot be protected by the seat belt and the air bag, so the occupant may receive a serious injury or lose his/her life.

Rear seat

Seatback Release Lever

To fold down the seatback, push the seatback release lever (A) toward the front of vehicle. The lever is attached to the side of the seatback.



Warning

- Releasing the seatback from its holding latch allows you to completely fold it. Ensure that your body parts are out of its way.

Warning



- Adjust the height of the head restraint so that the center of the head restraint is aligned with the occupant's eye level.
- Do not use the head restraint while it is lowered.
- When there is no occupant in the rear seats, the rear head restraints should be kept as low as possible as since they may obscure the rear view.

Head Restraint Adjustment

To raise the head restraint, pull it up without pressing the release button. To lower the head restraint, press the release button (B) on top of seatback and push the head restraint down.



Warning

- Removed or improperly adjusted head restraints can result in serious head and neck injuries in case of a collision.

Folding rear seatback

- 1 Lower the head restraint to its lowest position.

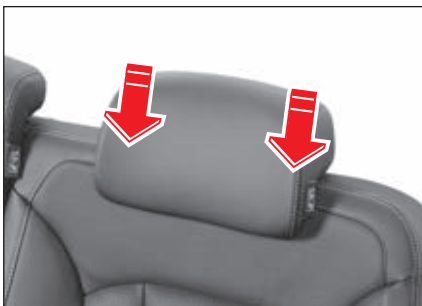

- 2 Push the rear seatback release lever (A) forward to release the seatback.

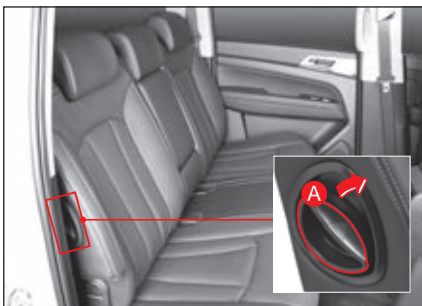

- 3 Fold the seatback forward.
- 4 Return the seatback to its original position in the reverse order of folding.



! Caution

- Folding the rear seatback without lowering the rear seat head restraint to its lowest position or with the front seatback reclined too much can damage the rear seat head restraint by hitting the front seatback or center console.
- Make sure the rear seatback is locked firmly after returning the seatback to an upright position. If the seatback is not secured, it can be folded down unexpectedly.
- If the seatback is raised up without the head restraint lowered completely, the head restraint may hit the rear glass causing the glass to be broken.

! Warning

- The seatback is released as soon as the rear seatback release lever (A) is pushed forward. Make sure that any body part of the occupants is not trapped by the folded seatback.
- Do not place any object on the surface of the folded seatback. You may get injured by the unsecured objects in a sudden stop. If it is necessary to put cargo on the seatback, make sure to securely tie down the cargo. Also, position the cargo so that it does not obscure your visibility through the rear window.
- Do not sit on the folded seat. You cannot be protected by the seat belt or proper restraint system and could get seriously injured in an accident.

Seat ventilation and heating*

Front seat ventilation and heating



- 1 Front seat ventilation button
- 2 Front seat heating button

Front seat ventilation

With the engine on, press the Front seat ventilation button (1).

The operation indicator (blue) turns on and the ventilation function is activated in the relevant seat.



- Each time the Ventilation button is pressed, the status of the ventilation function is changed in the order of OFF → Level 3 → Level 2 → Level 1 → OFF.
- When you press the Ventilation button for 1 second or longer while the ventilation function is operating, the function is deactivated.

Warning

- Do not insert your hand under the seat cushion while the seat ventilation function is operating. Doing so may cause your hand to be hit and injured by the spinning ventilation fan.

Notice

- The seat ventilation function is not the cooling seat that blows out cold air from the air conditioner.
- Since the seat ventilation function draws in air from inside the vehicle and performs the ventilation function, it is efficient to use it together with the air conditioner.
- When you turn off the engine while the seat ventilation function is operating, the ventilation function also turns off. The seat ventilation function won't turn on even if you start the engine again.

Front seat heating

With the engine on, press the Front seat heating button (2).

The operation indicator (yellow) turns on and the heating function is activated in the relevant seat.

- Each time the Heating button is pressed, the status of the heating function is changed in the order of OFF → Level 3 → Level 2 → Level 1 → OFF.
- When you press the Heating button for 1 second or longer while the heating function is operating, the function is deactivated.

Smart front seat heating control

This function controls the heating operation status automatically while assisting you to drive safely in a proper temperature condition.

- If the status of level 3 is maintained for approximately 30 minutes, the status of the heating function is changed to level 2 automatically.
- After the status is changed to level 2
 - When you activate the heating function in level 3 again within 5 minutes, the status of level 3 is maintained for approximately 8 minutes and then the status is changed to level 2 automatically.
 - When you activate the heating function in level 3 again after 5 minutes later, the status of level 3 is maintained for approximately 30 minutes and then the status is changed to level 2 automatically.
- If the status of level 2 is maintained for approximately 60 minutes, the status of the heating function is changed to level 1 automatically.



Warning

- **Using seat heating excessively on the driver seat may cause drowsiness and interfere with safe driving.**

Notice

- **The seat heating function is designed to stop its operation when the temperature rises to a certain level and resume its operation when the temperature falls below a certain level.**
- **When you turn off the engine while the seat heating function is operating, the heating function also turns off. The seat heating function won't turn on even if you start the engine again.**

Rear seat heating switch* (same for both sides)

Press the switch to heat the seat and press again to stop the seat heating. During heating, the indicator light on the switch comes on. The seatback heating function is not available in the rear seat.



Warning

- If the ignition is turned off during operation of the rear seat heating of the rear 1st row seat, the seat heating will be turned off and will not resume operation at the next start up. Extended use of the seat heating can cause overheating or fire. Make sure that the heating is turned off when you leave the vehicle.

Notice

- If the seat temperature exceeds the specified temperature range, the seat heating will be turned off. If the seat temperature goes below this range, the seat heating will resume function.
- When you cycle the ignition key to the OFF position and back to the ON position with the seat heating/ventilation activated, the seat heating and ventilation will not work. In order to reactivate, you have to turn the switch to the other positions.

Caution

- Do not operate the seat heating for a long time when the passenger is an infant, child, old or handicapped person, person with sensitive skin, person under the influence of alcohol, or excessively fatigued person. They might receive minor burns.
- If your skin is in contact with the heated seat for a long time, you might get low temperature burns. Be careful.
- Do not put anything on the seat that insulates heat, such as a blanket, cushion or seat cover.
- If the temperature continues to rise, turn the switch off and have the system checked by a KG Mobility Dealer or KG Mobility Authorized Service Center.
- In the case of the driver's seat, an excessive usage of the heated seat might make you sleepy and could negatively affect your safety.
- Do not place anything sharp on the seat. This may cause damage to the seat heating.

Warnings and cautions related to the seats



Warning

- Be sure to finish adjusting the seat before driving.
- Never adjust the seat while driving. If the seat moves suddenly, it may lead to a dangerous situation.
- Adjust the seat backrest to be upright as possible to maintain a comfortable position. Reclining the seat backrest excessively may cause the occupant to slip down below the seat belt in the event of a vehicle collision or sudden stopping. In such case, the occupant cannot be protected by the seat belt and the air bag, so the occupant may receive a serious injury or lose his/her life.
- Never drive the vehicle with the headrest separated. Doing so may cause head, neck or spine injury.
- If the power seat does not operate, drive the vehicle after checking and taking measures.
- Caution should be taken that using the seat heating function excessively may cause a minor burn. Pay particular attention to an infant, a small child, an elderly, a disabled person, a person who took a drug that induces sleep, a drunk person, an over-worked person or a person with delicate skin.



Caution

- The power seat operates even when the START/STOP switch is in the OFF status. However, caution should be taken that operating the power seat too frequently when the engine is turned off may cause depletion of the battery.
- Operating a number of seat adjustment switches at the same time may damage the motor. Be sure to finish using one function before using another function.
- If the power seat comes into contact with an object so that it does not move or operate, do not operate it forcibly. Operate it again after eliminating the cause. If there is abnormality, have your vehicle checked and serviced at a KG Mobility Corporation authorized service center.
- Do not place an object that can damage the seat upholstery on top of the seat.
- Do not use organic solvents such as thinner, benzene, alcohol or gasoline for cleaning the seat upholstery. Doing so may damage the surface of the upholstery.

Window (power window)



- 1 Driver door window switch (AUTO)
- 2 Passenger door window switch
- 3 Rear left door window switch
- 4 Rear right window switch
- 5 Door LOCK/UNLOCK switch
- 6 Window LOCK switch

Notice

- To operate the window, the START/STOP switch should be in the ON status or the engine should be running.
- Even if the START/STOP switch is switched from the ON status to the ACC status or the OFF status, the Window button can be operated for approximately 30 seconds. However, the operation stops immediately when you open the front door.

Opening/closing the driver seat/front passenger seat window

Opening the driver seat/front passenger seat window



- Press the Driver seat/Front passenger seat window button slightly. The Window opens only while the button is being pressed.
- Press the Driver seat/Front passenger seat window button to the end and release it. The window opens to the end automatically (auto down).
- When you slightly press or pull the Driver seat/Front passenger seat window button up while the window is opening, the window stops.

Closing the driver seat/front passenger seat window



- Pull the Driver seat/Front passenger seat window button up slightly. The window closes only while you are pulling the button.
- Pull the Driver seat/Front passenger seat window button up to the end and release it. The window closes to the end automatically (auto up).
- When you press or slightly pull the Driver seat/Front passenger seat window button up while the window is closing, the window stops.

Driver seat window safety function

The driver seat window safety function controls the driver seat window equipped with the auto up function to move down slightly and stop without moving up from its position when it is recognized that a body part or an object is caught in it when the window is closing.



Notice

- The window safety function is activated only on the driver seat window equipped with the auto up function.
- The safety function is not activated for some section of the window that is closed lastly.
- The window may get frozen during winter so that it may be misrecognized as a body part or an object being caught in it. In such case, close the window little by little by pulling the Window button slightly.
- When you do not release the Window button after pulling it up to the end, the window is closed to the end without stopping even if there is an obstacle in its moving path.

This function is intended to protect the driver from a crime such as robbery and injury.

Opening/closing the rear seat window



- The window operates only while the Window button is being pressed or pulled.

Rear seat window lock function

This function locks the window so that it cannot be opened and closed from the rear seats.

Press the Rear seat window lock button.



Warning

- **If a small child is seated in the rear seat, be sure to press the Rear seat window lock button to make the Window buttons inoperative. It can prevent an accident caused by the child's mischief.**

What is wind buffeting?

Wind buffeting is the phenomenon when you feel pressure upon your ears or hear some noises such as the sound of a helicopter when you drive the vehicle with a rear seat window or the sunroof opened to a certain position.

This phenomenon occurs when air flows in through the rear seat window or the sunroof, creating resonance.

If you adjust the open space of the rear seat window or the sunroof when the wind buffeting occurs, such phenomenon disappears or is reduced.



Warning

- **While driving or stopping, do not hold a part of your body such as your hand or head out of the window. You may get injured by a passing vehicle or an outside obstacle.**
- **Be careful not to get a part of your body such as your hand or head to be caught in the window when operating the window.**



Caution

- **Operating a number of Window buttons at the same time may damage the fuse that is the over-current protective device or the window system.**
- **Operating the Window buttons on the driver seat door and a different door in the opposite direction at the same time may damage the window system.**

Sunroof*

The sunroof is a secondary window installed on the vehicle roof for supporting pleasant driving such as ventilation and lighting in the vehicle.

The sunroof window can be slide opened and closed and it also operates in a tilting way to lift the rear section of the sunroof up slightly.

The sunroof cover can be opened and closed by hand.

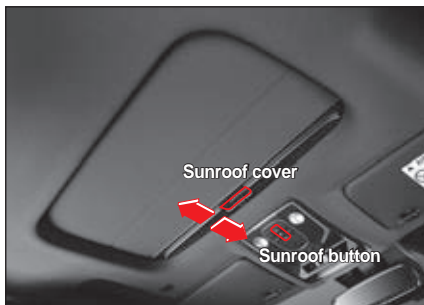
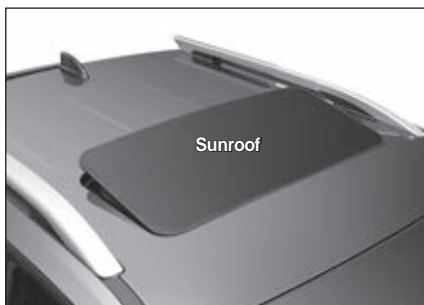

Warning

- While driving or stopping, do not hold a part of your body such as your hand or head out of the sunroof. You may get injured by a passing vehicle or an outside obstacle.

Caution

- The sunroof operates even when the START/STOP switch is in the ON status. However, caution should be taken that using the sunroof excessively while the engine is not running may cause depletion of the battery.
- After finishing the sunroof operation, release the Control button. Pressing the Control button continuously may cause a malfunction.
- If the sunroof is opened completely, the wind buffeting may become intensified. In such case, adjust the open space in the sunroof.
- If the sunroof operation part is frozen during winter, operate it after the frozen part melts completely.

Caution

- Remove dust and foreign materials from the rubber part around the sunroof window periodically. If dust and foreign materials are present, noise may occur when the sunroof operates and it may cause a malfunction.
- When loading the cargo on the roof rack over the vehicle equipped with the sun roof, be careful not to interrupt the sun roof operation.

Notice

- To operate the sunroof, the START/STOP switch should be in the ON status or the engine should be running.

Opening/closing sun shade blind

The sunshade blind does not operate with the sunroof button. In order to open the sunshade blind, press the part labeled PUSH (A) on the front of the sunshade blind upwards, and to close it, pull it forward.

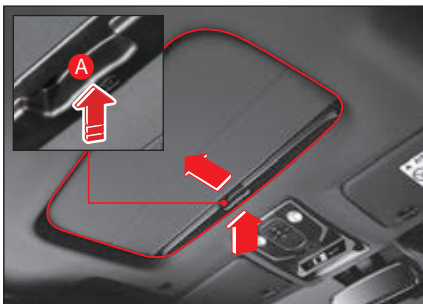

⚠ Caution

- Do not operate the sunroof with the sunshade blind closed.
- Do not apply excessive force to the sunshade blind.
- Always open or close the sunshade blind with the sunroof fully closed. In particular, do not drive the vehicle with the sunshade blind closed while the sunroof is open.

Opening the sunroof

Opening automatically

Press the sunroof open button briefly. The sunroof opens automatically.

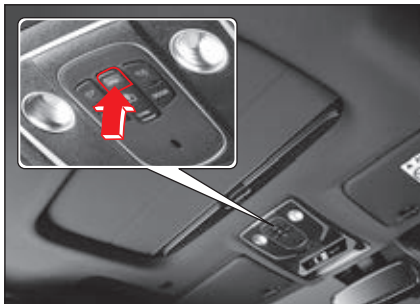

⚠ Caution

- When the sunroof is fully sliding open, wind buffeting symptom can be worse. In this case, be sure to adjust the sunroof position manually.

Notice

- Operating the switch while the sunroof is opening stops the sunroof operation.

Manual open

- Step 1 (tilt up):
The rear part of the sunroof opens when the switch is pressed down to the OPEN direction with the sunroof closed.
- Step 2 (opens by itself from tilted up condition)
When pressing the switch to the "OPEN" position with the sunroof tilted up, it opens only whilst pressing the switch.

What is wind buffeting?

Wind buffeting is the phenomenon when you feel pressure upon your ears or hear some noises such as the sound of a helicopter you when you drive the vehicle with a rear seat window or the sunroof opened to a certain position.

This phenomenon occurs when air flows in through the rear seat window or the sunroof, creating resonance.

If you adjust the open space of the rear seat window or the sunroof when the wind buffeting occurs, such phenomenon disappears or is reduced.

Closing the sunroof

Closing automatically

Press the sunroof close button briefly. The sunroof closes automatically.

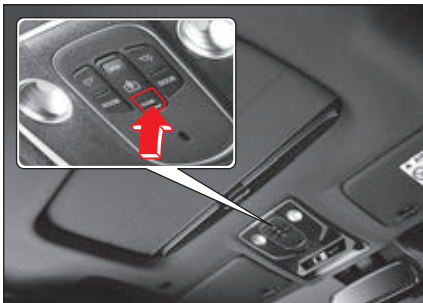

Notice

- Operating the switch while the sunroof is closing stops the sunroof operation.

Closing manually

Press and hold the sunroof close button. The sunroof will be closed only while you are pressing the close button.

In order to close the sunroof fully, you have to keep pressing the close button.

Sunroof open warning

When you place the START/STOP switch in the ACC or OFF position and open the driver seat door with the sunroof opened, the sunroof open warning buzzer will sound.

When you close the door, the warning buzzer will be turned off.

When the sunroof open warning buzzer sounds, leave the vehicle after closing the sunroof completely.



Caution

- When leaving the vehicle, check if the sunroof is closed completely. Leaving the vehicle with the sunroof opened may cause a robbery case through the sunroof. Also, the inside of the vehicle may get wet when it rains or snows.

Resetting the sunroof

Cases requiring the resetting of the sunroof

- When the battery is depleted or the power supply is suspended with the sunroof opened
- When the sunroof does not open or close completely by operating the button once
- When the sunroof is tilted without stop after it is closed in the sliding method
- When the moving distance has decreased significantly when sliding or tilting the sunroof
- If the sunroof does not operate or operates abnormally when the Sunroof button is pressed

Resetting

With the sunroof tilted up (opening the rear section), press the Sunroof close button continuously for approximately 20 seconds.

- A clicking sound occurs once approximately 5 seconds later and once again approximately 20 seconds later after press the Sunroof close button. The sunroof resets along with the second clicking sound.
- When you press the Sunroof close button slightly after resetting, the sunroof opens and closes again automatically.



Caution

- **If the sunroof does not operate normally after resetting the sunroof, have your sunroof checked and serviced at a KG Mobility Corporation authorized service center.**

Loading goods

Tailgate opening/closing



To open the tailgate, pull the lever to unlock the tailgate and lower it slowly with both hands. After loading, raise and close the tailgate.

Locking or unlocking doors using the driver's or passenger's door opening knob or switch also locks or unlocks the tailgate.

Opening Tailgate

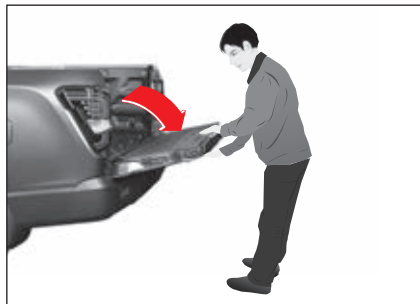

Notice

- The door ajar warning light does not come on when the tailgate is open. Make sure that the tailgate is closed before driving.
- If you hear the noise from the hinge/torsion spring when opening or closing the tailgate, apply the specified lubricant (Heat resistance fluorine grease, PTFE Grease, refer to KS M2130). Maintenance schedule: check the hinge/torsion spring at every 20,000 km or 1 year (under severe conditions: check the hinge/torsion spring and lubricant frequently)
- MUSSO & MUSSO GRAND has no key hole on the tailgate to lock or unlock it.

Closing Tailgate

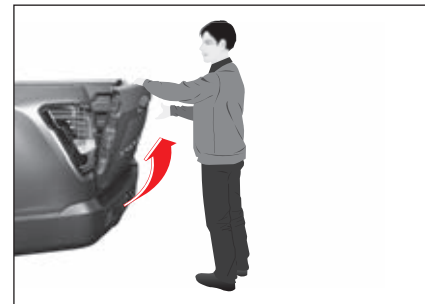

Notice

- To open the tailgate, hold the tailgate with both hands, and then lower it slowly. Failing to hold the tailgate with both hands makes it risky of being dropped, which may damage it or cause personal injury.
- To close the tailgate, hold the lever with one hand and raise the tailgate slowly with the other hand as illustrated.
- Before closing the tailgate, ensure that your body parts are completely out of its way. To prevent any injury, close the tailgate with caution.
- Do not let children or senior citizens open the tailgate. The heavy tailgate might unexpectedly fall down and cause injury.

Loading goods on the deck

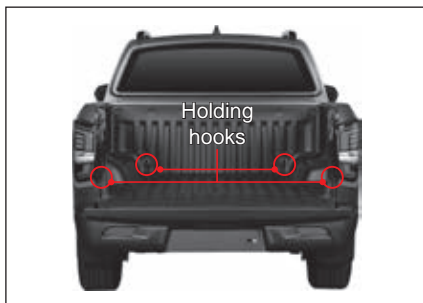

Full load

(kg)

		EU		
MUSO	D22DTR	A/T	2WD: 485 (without trailer) 348 (with trailer) 4WD: 485 (without trailer) 340 (with trailer)	
		M/T	2WD: 495 (without trailer) 358 (with trailer) 4WD: 495 (without trailer) 358 (with trailer)	
			GEN	
	D22DTR	A/T	2WD: 465 (without trailer) 328 (with trailer) 4WD: 415 (without trailer) 270 (with trailer)	
		M/T	2WD: 475 (without trailer) 338 (with trailer) 4WD: 425 (without trailer) 288 (with trailer)	
	G20D	A/T	2WD: 465 (without trailer) 328 (with trailer) 4WD: 415 (without trailer) 270 (with trailer)	
M/T		2WD: 475 (without trailer) 338 (with trailer) 4WD: 425 (without trailer) 288 (with trailer)		
MUSO GRAND (5-Link)			EU	
	D22DTR	A/T	2WD: 495 (without trailer) 366 (with trailer) 4WD: 495 (without trailer) 350 (with trailer)	
		M/T	2WD: 505 (without trailer) 376 (with trailer) 4WD: 505 (without trailer) 376 (with trailer)	

(kg)

		GEN		
MUSSO GRAND (5-Link)	D22DTR	A/T	2WD: 510 (without trailer) 381 (with trailer) 4WD: 505 (without trailer) 360 (with trailer)	
		M/T	2WD: 515 (without trailer) 386 (with trailer) 4WD: 515 (without trailer) 386 (with trailer)	
		EU		
MUSSO GRAND (Leaf)	D22DTR	A/T	2WD: 700 (without trailer) 555 (with trailer) 4WD: 700 (without trailer) 555 (with trailer)	
		M/T	2WD: 710 (without trailer) 581 (with trailer) 4WD: 710 (without trailer) 581 (with trailer)	
			GEN	
	D22DTR	A/T	2WD: 640 (without trailer) 495 (with trailer) 4WD: 635 (without trailer) 490 (with trailer)	
M/T		2WD: 650 (without trailer) 521 (with trailer) 4WD: 645 (without trailer) 516 (with trailer)		
G20D	A/T	2WD: 640 (without trailer) 495 (with trailer) 4WD: 635 (without trailer) 490 (with trailer)		
	M/T	2WD: 650 (without trailer) 521 (with trailer) 4WD: 645 (without trailer) 516 (with trailer)		

After loading the goods on the deck, ensure they are firmly secured using the hooks on the side panels.



Warning

- Never allow people to get on the deck. It should be used only for loading goods.
- To prevent your goods on the deck from being stolen, unload and store them in a safe place upon arriving at the destination.
- After loading, close and lock the tailgate. Make sure that the tailgate is locked securely by swaying it back and forth.
- Do not drive with the tailgate open.



Warning

- Never exceed the tailgate's loading capacity. Overloading may damage the tailgate, power train, suspension or relevant components, and may also impair the driving safety and place you at risk for an accident.
- Do not alter the cargo area by using canvas or other materials as roofing, or modify installed components. Any modifications or alterations to this vehicle could seriously affect its roadworthiness and safety, decrease the vehicle's fuel economy and cause the panels to rust. Moreover, alterations may increase the total weight of the vehicle and impair the driver's rearview, which may lead to an accident.
- Avoid loading goods taller than the side panels.
- Do not load metal bars, other sharp-edged materials or particularly voluminous goods that may block the rearview.
- During a hard braking, collision or accident, metal bars or other sharp-edged materials that exceed the deck's loading width or height may get through the rear window and may result in serious, sometimes fatal injury.



Caution

- Keep the deck away from direct sunlight, rain or snow when parking. Water or snow on the deck should be removed before driving.
- Tailgate, deck floor and tailgate hinges can be damaged or broken if you throw the goods or jump on the tailgate while the tailgate is open.
- When holding or tying down the goods using ropes or wires, never use the opening on the upper part of the deck cover. The cover and its painted surface can be damaged.

Engine hood

Opening the engine hood

- 1 Pull the engine hood open lever (1) located at the bottom left side of the driver seat.

The engine hood will be opened slightly.

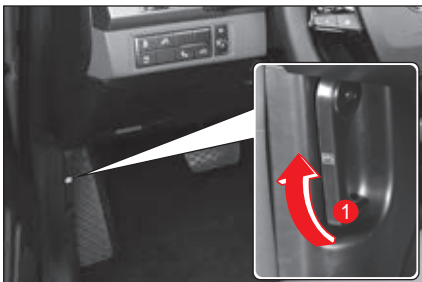

- 2 With the engine hood lifted slightly, push the engine hood fixing lever (2) in the arrow direction.

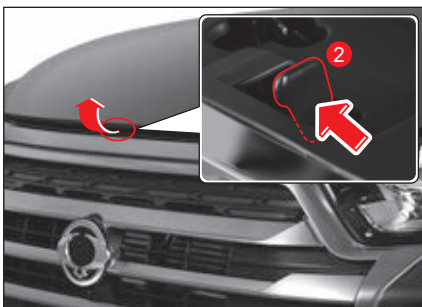

- 3 Lift the engine hood up.
When you lift engine hood half way, it will open to the end automatically.

Closing the engine hood

Checking before closing the engine hood

- Make sure that all inlet caps in the engine room are closed properly.
- Check that no unnecessary items including gloves and tools are left in the engine room.

Closing the engine hood

Pull the engine hood down and close it by pressing it down.

Caution

- If the engine hood is lifted slightly while it is closed, open the engine hood again and close it by pushing it with stronger force.
- When Replacing and disposing of gas lifter, have your vehicle serviced at a KG Mobility Corporation authorized service center.

Warning

- Open the engine hood after turning off the engine. However, if you need to check and carry out services with the engine on, pay particular attention not to be injured by the operating devices in the engine room.
- Check the engine hood in a place where no wind blows. You may get injured if the engine hood is closed by wind.
- Be careful not to get any of your body parts such as fingers caught when closing the engine hood.
- Confirm that the engine hood is closed completely before driving. If you drive the vehicle with the engine hood open, the vehicle may get damaged and it may block the driver's vision, causing a serious accident.
- Do not disassemble the hood support bars. It is composed of the high pressure devices, which may cause injuries.
- Do not apply heat the hood support bars. It may be damaged by heat and cause injuries.

Fuel inlet

Opening the fuel inlet

The fuel inlet cover can be opened only when all doors are unlocked.

- 1 Shift the gear shift lever to the P (Parking) position.
- 2 Apply the parking brake.
- 3 Be sure to turn off the engine.
- 4 Push (A) the center edge of the fuel inlet cover in the arrow direction.
- 5 Open the fuel inlet cover completely by pulling it in the arrow direction.

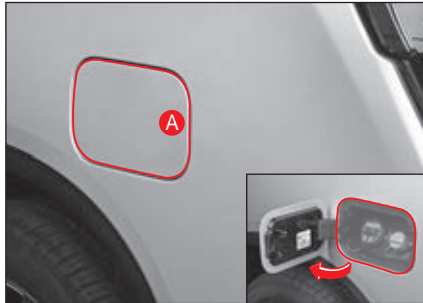

⚠ Caution

- If the fuel inlet cover is frozen during winter, do not open it forcibly. Open it by gently tapping on the edge of the cover.

- 6 Open the fuel inlet cap by turning it counterclockwise.

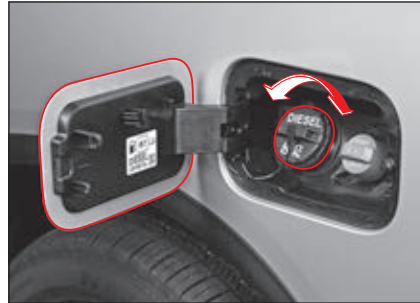

- 7 Hang the fuel inlet cap on the holder mounted inside the fuel inlet cover.

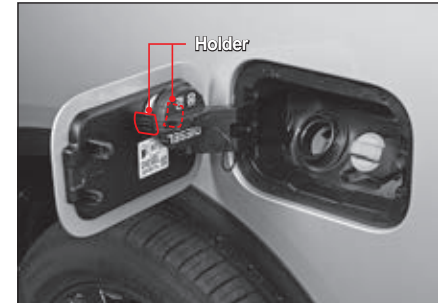

⚠ Warning

- Separate the fuel inlet cap carefully since pressure may be applied to the fuel. If you hear a sound of fuel leakage or deflation, wait until such sound stops and then separate the cap again. Failure to do so may cause fuel to emit, causing a serious injury.
- When you touch the fuel inlet cap or the gas pump, contact a metal part that is far away from the fuel inlet with bare hands first to remove static electricity. Failure to do so may cause a fire due to static electricity.

Closing the fuel inlet

- 1 Close the fuel inlet cap by turning it clockwise until a clicking sound occurs.
- 2 Close the fuel inlet cover by pushing the center edge of the fuel inlet cover.

Information - Fuel label

• PETROL TYPE OF FUEL



The shape for a petrol- type fuel is a circle ("E" stands for specific bio-components present in petrol)

• DIESEL TYPE OF FUEL



The shape for a diesel-type fuel is a square ("B" stands for specific biodiesel components present in diesel)

Warning

- Be sure to refuel after stopping the engine. Failure to do so may cause vaporized fuel to ignite due to a spark generated from an electrical device when starting the engine, causing a serious fire.
- Keep any Inflammables such as a lighted cigarette or a lighter away during refueling. Failure to do so may cause a serious fire.
- Do not take an action that may generate static electricity such as getting in and out of the vehicle during refueling. Doing so may cause a serious fire due to static electricity.
- If it is necessary to refuel using a portable container, refuel with the container placed on the ground. Refueling with the container placed on top of or inside the vehicle may cause a serious fire due to static electricity.
- Be sure to refuel after checking the type of the fuel used. If you misfuel a vehicle using diesel or gasoline, the fuel system and other vehicle systems may be affected, damaging the vehicle significantly.
- Do not use fuel containing a lot of moisture, improper fuel or additives. Doing so may damage the fuel system and the exhaust gas system of the vehicle significantly.

- Refuel only until the pump nozzle of the fuel supply gun stops automatically. Filling the fuel tank excessively may cause fuel to overflow, causing a fire and damaging the vehicle body.
- Do not use a mobile phone near a gas station. Doing so may cause a fire due to an electromagnetic wave or current of the mobile phone.
- If a fire occurs while refueling, evacuate to a place far from the vehicle immediately. Then, take measures such as the reporting the fire.

Caution

- Be careful not to allow the fuel to contact the vehicle body as it can damage the painted surface.
- Be sure to use a genuine fuel inlet cap when it is necessary to replace it.

Lights and lamps

Outdoor lights/lamps

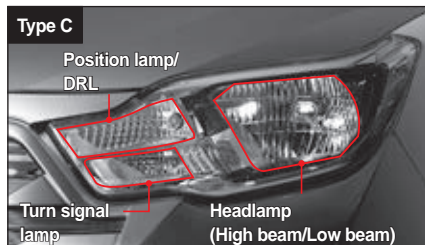
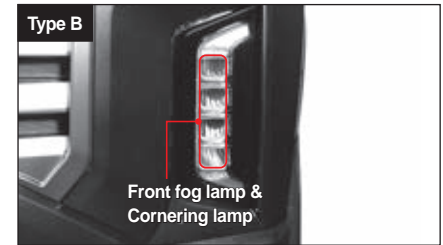
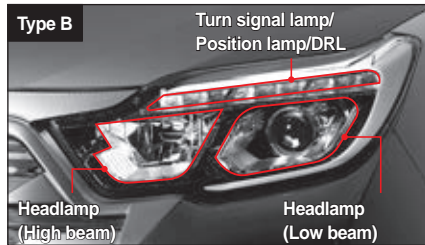
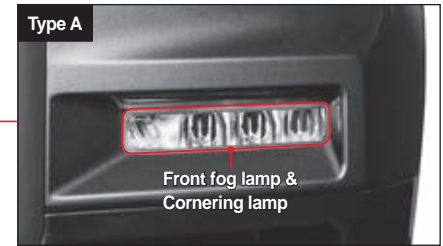
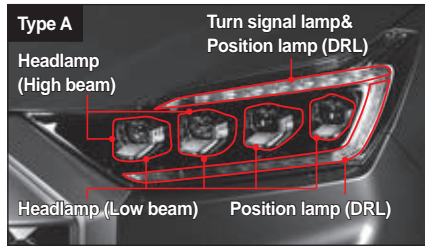

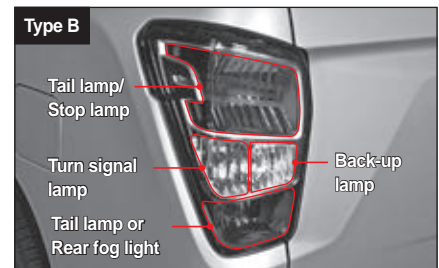
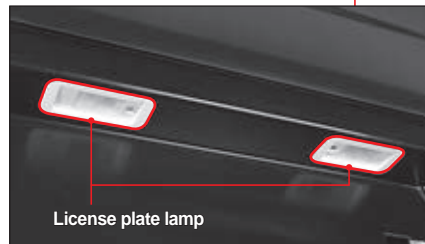
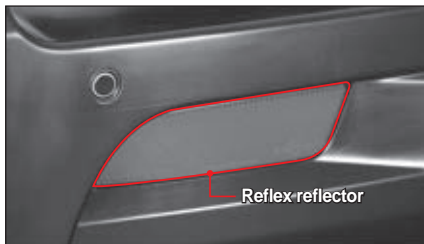
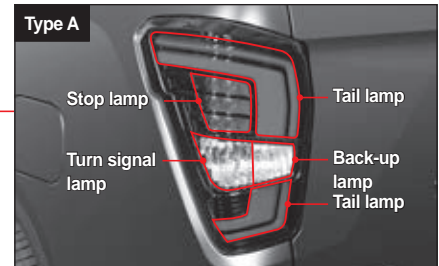
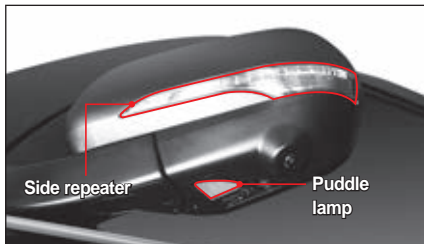

Light switch

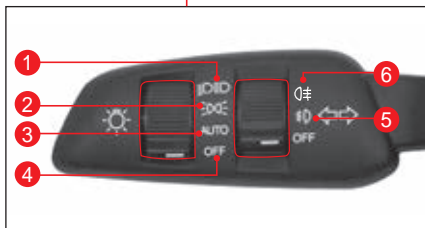
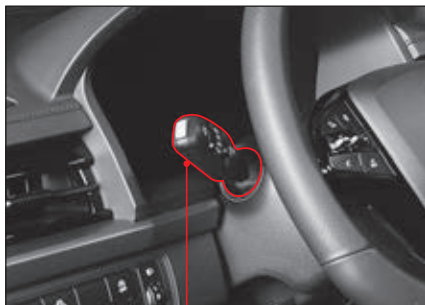

- 1 Head light
- 2 Tail light
- 3 Auto light function
- 4 Turning off all lights
- 5 Front fog light
- 6 Rear fog light

Turning on the head light

The head light turns on along with the sidelight, tail light, license plate lamp, front fog light (in the ON status) and other interior lights.

Turning on the tail light

The tail light turns on along with the sidelight, license plate lamp, front fog light (in the ON status) and other interior lights.

AUTO Activating the auto light function

The head light and the tail light turn on or off automatically according to the amount of sunshine received by the auto light sensor.

Turning on High Beam Assist (HBA)

Pushing the Light switch in the direction of instrument cluster with the Light switch in the AUTO position activates the HBA.

 Refer to "Smart High Beam (SHB)**" (p.3-37)

OFF Turning off all lights

All lights turn off.

Turning on the front fog light*

When you place the Light switch in the  (front fog light) position with the head light or the tail light on, the front fog light turns on.

Turning on the rear fog light*

With the headlights turned on, if you rotate the switch in  position, rear fog lights turn on and the switch returns back in front fog light position. Rear and front fog lights turn on simultaneously.

Turning it again will turn off the rear fog lamp.

OFF Turning off the front fog light

The front fog light turns off.

Turning on/off the left/right turn signal

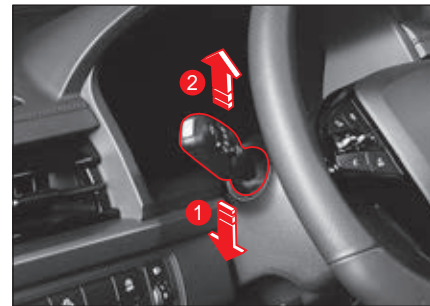

- When you push the Light switch down (1), the left turn signal blinks. At this time, the turn signal on the instrument cluster also blinks.
- When you push the Light switch up (2), the right turn signal blinks. At this time, the turn signal on the instrument cluster also blinks.

Turning on/off the high beam



Type A

- When you push the Light switch in the direction of instrument cluster and release it with the low beam on, the high beam turns on. At this time, the high beam indicator on the instrument cluster also turns on.

Type B

- To turn on the headlamp high beam, push the lever towards the instrument cluster with the headlamp low beam on. The headlamp high beam indicator (⊞) in the instrument cluster comes on when the headlamp high beam is turned on.

When you pull the Light switch in the driver's direction and release it with the high beam on, the high beam turns off.



Warning

- Do not turn on the high beam if there is an oncoming vehicle or a vehicle at the front. The high beam may block the other drivers' vision, causing an accident.

Turning on the high beam and low beam at the same time (passing light)



The high beam and the low beam turn on at the same time while pulling the Light switch in the driver's direction.

Notice

- This function operates regardless of the position of the Light switch.

Hazard warning lamp

The hazard warning lamp is used to give warning to other vehicles in the event of emergency for preventing an accident.

- When you press the Hazard warning lamp switch, all turn signals blink.
- When you press the Hazard warning lamp switch again, the hazard warning lamp turns off.

☞ Refer to "Emergency Stop Signal (ESS)*" (p.4-152)



Caution

- Do not operate the hazard warning lamp for a long period of time with the engine off. Doing so may cause confusion to other vehicle drivers as well as depletion of the battery.

Notice

- The hazard warning lamp operates regardless of the status of the START/ STOP switch
- While the hazard warning lamp is operating, the turn signal does not operate independently.



Adjusting the angle of the head light

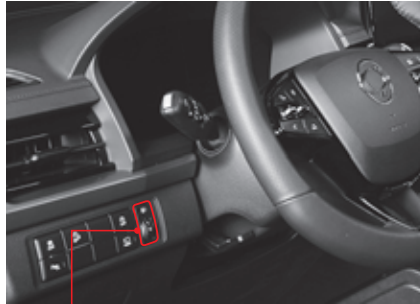

The front and rear slope of the vehicle may vary depending on the number of occupants, weight and center of gravity of luggage.

In such case, you can adjust the angle of the head light to secure proper vision at night and not to obstruct an oncoming vehicle or a vehicle at the front with a strong light from the head light.

Angle adjustment levels of the head light

The angle of the head light can be adjusted in 4 levels (Levels 0~3) according to the front and rear slope of the vehicle.

- When the vehicle is tilted forward Lower the head light angle adjustment dial (Level 0 direction). The head light is adjusted to face up.
- When the vehicle is tilted backward Raise the head light angle adjustment dial (Level 3 direction). The head light is adjusted to face down.

Angle adjustment standard for the head light

	Aiming level adjustment
Level 0 	- 1 to 5 occupants
Level 1 	- 1 occupant + Up to 200 kg load - 2 to 5 occupants + Up to 100 kg load
Level 2 	- 1 occupant + Up to 300 kg load - 2 to 5 occupants + Up to 200 kg load
Level 3 	- 1 occupant + Up to 400 kg load - 2 to 5 occupants + Up to 250 kg load

Warning

- Drive the vehicle after adjusting the angle of the head light according to the number of occupants, weight and center of gravity of luggage. Failure to do so may cause an accident.
 - Never drive the vehicle in any of the following cases that go beyond the angle adjustment standard for the head light.
 - Driving the vehicle with level 3 under the condition of level 0 (the angle of the head light is lowered): It takes longer for the driver to recognize an emergency situation on the road ahead if it occurs.
 - Driving the vehicle with level 0 under the condition of level 3 (the angle of the head light is raised): It obstructs the vision of the driver in an oncoming vehicle or a vehicle at the front.
- In such case, it may obstruct safe driving, causing a serious accident.

Daytime Running Light (DRL)*

The DRL also turns on automatically during daytime, allowing you to recognize a vehicle easily.



In case the DRL turns on

- If the switch of the tail light, front fog light and head light is not operated with the START/ STOP switch in the ON (irrelevant to whether the engine is started or not) status

Notice

- When the DRL turns on, the tail light also turns on at the same time.
- The same lamp is used for the DRL and the tail light, but the DRL is more bright.

In case the DRL turns off

- When the DRL function is deactivated
- When the START/STOP switch is in ACC or OFF status
- When the hazard warning indicator is activated

Type A, B	Type C
DRL deactivated when hazard warning indicator flashing	DRL stays on when hazard warning indicator flashing

- When the left / right turn signal indicator is activated

Type A, B	Type C
Corresponding side DRL deactivated when left / right turn signal indicator activated	DRL stays on whether left / right turn signal indicator activated or not

- When you turn on the front fog light
- When you drive the vehicle at a speed of 3km/h or less with the parking brake applied

Smart High Beam (SHB)*

The SHB is the function to control the high beam not to obstruct the vision of a driver in an oncoming vehicle or a vehicle at the front with a strong light from the high beam.

The SHB detects the situation through the sensor at the top of the vehicle windshield (front camera module) and turns on or off the high beam automatically.

Setting the SHB

- 1 Place the Light switch in the AUTO position.



- 2 Push the Light switch in the direction of instrument cluster and release it.



- When the SHB function is activated, the SHB indicator turns on.



SHB indicator

In case the high beam turns on

All the following conditions are set with the SHB activated, the high beam turns on.

- When the vehicle speed is 35 km/h or faster
- When the surrounding area is dark that it is detected as night
- When an oncoming vehicle and a vehicle at the front are not detected

When the light beam turns on automatically, the SHB indicator turns on along with the high beam indicator.



SHB indicator



High beam indicator

In case the high beam turns off

The high beam turns off in any of the following cases.

- When the head light of an oncoming vehicle (including a bicycle and a motor cycle) is detected
- When the tail light of a vehicle (including a bicycle and a motor cycle) at the front is detected
- When it is bright in the surrounding area due to streetlights or other lighting sources in the surrounding roadside.
- When the light source of a tunnel is detected
- When the Light switch is not in the AUTO position
- When the SHB function is deactivated
- When the vehicle speed is less than 25 km/h

Notice

- **When the high beam turns off and then turns on again automatically, there may be a delay time for few seconds.**

Operating the Light switch

The detailed operation of the Light switch with the SHB set and activated is as follows.

- When you push the Light switch in the direction of the instrument cluster with the SHB set and operating, the high beam turns on and the SHB setting is canceled.
- When you pull the Light switch in the driver's direction with the SHB set, the high beam turns on and the SHB setting is maintained only while pulling the Light switch.
- When you pull the Light switch in the driver's direction while the SHB is operating, the high beam turns off and the SHB setting is canceled.
- When you place the Light switch in positions other than the AUTO position, the SHB setting is canceled.

Caution

In any of the following cases, the SHB may not operate normally.

- **When the vehicle windshield is damaged or contaminated by dust, mist, fog, sticker, snow, etc**
- **When the lamp of an oncoming vehicle or a vehicle at the front is damaged**
- **When an oncoming vehicle or a vehicle at the front is out of your front sight**
- **When an oncoming vehicle and a vehicle at the front are recognized only partially in an intersection or a winding road**
- **When there is a light source similar to a vehicle lamp or a reflector at the front**
- **When an illuminator or a reflector is installed in a construction section, etc.**

Welcome light

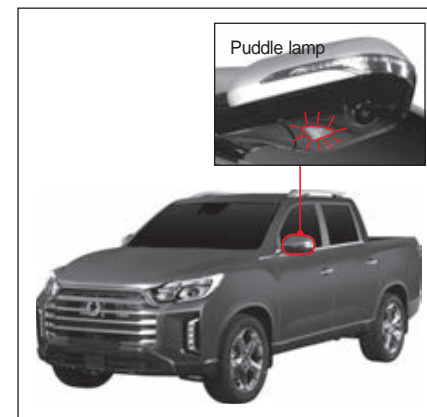

The welcome light is the function that operates the puddle lamp and the door handle lamp (DRL & Low beam: A type only) in order to increase safety and visibility at night.

If any one of the following conditions is met, the welcome light (puddle lamp and door handle lamp) turns on for approximately 30 seconds.

- When you press the door Lock/Unlock button on the smart key with all doors closed
- When you press the door handle Lock/Unlock button on the smart key in the theft monitoring mode and with all doors closed
- When you approach within 1 m from the vehicle in the theft monitoring mode while carrying the smart key

Coming-Home Light Control

Coming-home light ON

If the ignition switch is turned from ON to OFF with the headlamps (low beam) ON, the headlamps (low beam) stay on for the set time.

Coming-home light OFF

- The headlamps (low beam) are turned off after the set time with all doors including the tailgate closed.
- If any door or the tailgate is open during this set time, the headlamps (low beam) will be turned off after 3 min.
- If any open door or the tailgate is closed during this set time, the headlamps (low beam) will be turned off after the set time.
- Turning the AUTO light and headlamp (low beam) switch to the off position turns off the light immediately.

Leaving-Home Light Control

Leaving-home light ON

If the theft deterrent is disarmed by pressing the door UNLOCK switch on the smart key or door handle switch, the headlamps (low beam) come on and stay on for the set time.

Leaving-home light OFF

- The headlamps (low beam) are turned off after the set time for leaving-home light.
- Pressing the door LOCK switch on the smart key with leaving-home light ON turns off the headlamps (low beam). (Theft deterrent system is armed.)
- Turning on the ignition switch with leaving-home light ON turns off the light immediately.

Setting the coming home/leaving home light

• Supervision type

Go to **Vehicle Settings** → **Light** → **Leaving Home Headlamp** in  (User Settings) in the instrument cluster and set the time for **coming home headlamp**.

• Standard type

Go to **Light** → **Leaving Home Headlamp** in  (User Settings) in the instrument cluster and set the time for **coming home headlamp**.

Auto light function*



The auto light is the function that detects the amount of sunshine through the sensor and turns on or off the head light and the tail light automatically.

- The auto light function is activated when the Light switch is positioned in the AUTO position.

Auto light sensor

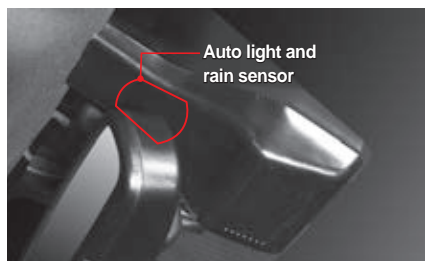

The auto light sensor is integrated with the rain sensor.



Caution

- When you shake or apply an impact to the auto light sensor, the auto light may malfunction.
- Do not wipe the auto light sensor installation part with cleaning agents or wax, etc. The auto light function may malfunction.
- Attaching commercially available window coating or tinting products to the windshield may cause the auto light function to malfunction.
- If the vehicle vibrates significantly just as driving on a road with an uneven surface, the auto light function may malfunction.
- The time to turn on and off the light may vary depending on a change in the climate condition such as fog, snow and rain and surrounding environment.

- When you change the Light switch to the AUTO position or from the AUTO position to another position, the lights inside the vehicle, tail light and head light may blink momentarily. This is a normal phenomenon for recognizing the status of the auto light.
- When passing through a dark place such as a tunnel, do not depend on the auto light function and turn on the head light manually.
- Use the auto light function for the head light and the tail light limitedly only at the time of sunrise and sunset. In general, operate the head light and the tail light manually.
- Do not use the auto light function for the head light and the tail light on a gloomy day. Operate such lights manually.

Interior lamp

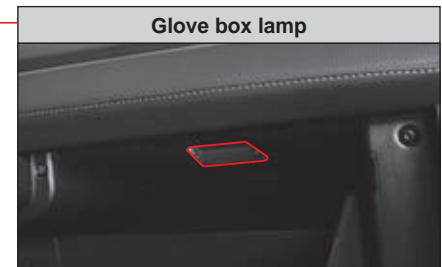
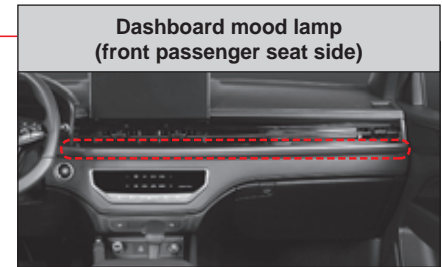
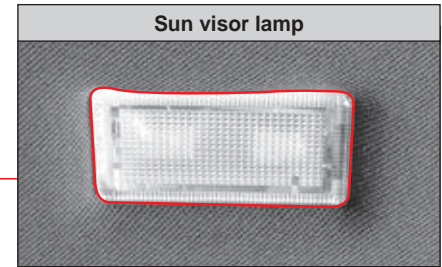
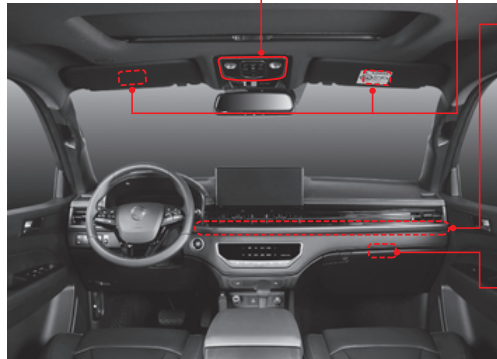
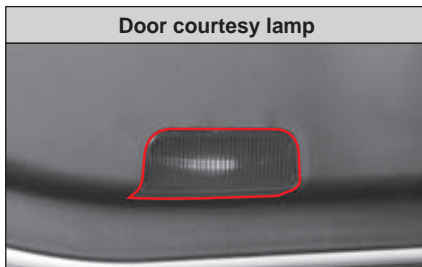
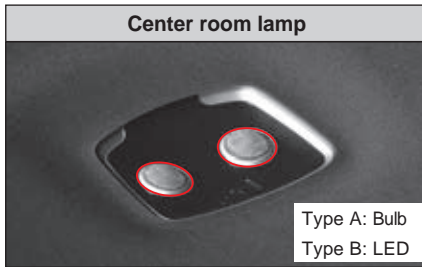
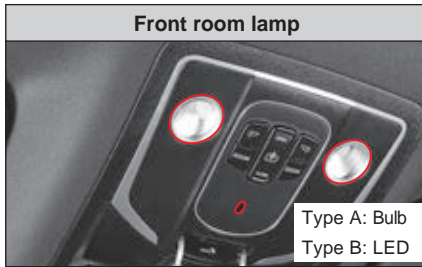

Front room lamp (overhead console)



- 1 Driver seat spot switch
- 2 Front passenger seat spot switch
- 3 Driver/passenger/center room lamp/spot switch
- 4 Door-linked switch
- 5 Front spot lamp

Warning

- Avoid using the interior room lamp when driving at night or in a dark place. The light of the interior room lamp may obstruct the front vision of a driver, causing an accident.

Notice

- When the interior room lamp is turned on after the engine is turned off, the room lamp turns off automatically after approximately 10 minutes in order to prevent depletion of the battery.

Driver seat spot switch

When you press the switch (1), the driver seat front room lamp turns on.

Front passenger seat spot switch

When you press the switch (2), the front passenger seat front room lamp turns on.

Driver / passenger / center room lamp spot switch

When you press the switch (3), the driver / passenger / center room lamp turns on.

Door linkage switch

When you open the door with the switch (4) pressed, the front room lamp and the center room lamp turn on, and when you close the door, those lamps turn off.

Front spot lamp (5)

It illuminates when the tail lamp is turned on.
It illuminates the front center area dimly.

Linkage function between the smart key and the front room lamp

When you unlock the door using the smart key with the front room Lamp door linkage switch pressed, the driver seat and front passenger seat room lamps turn on for 30 seconds.

At this time, when you lock the door by pressing the Door lock button on the smart key, the driver seat and front passenger seat room lamps turn off immediately.

Caution

- Do not leave the door open for a long time with the room lamp linked to the door or leave the vehicle when the room lamp is turned on. If the room lamp stays on for a long period of time, the battery may be depleted.

Center room lamp



Pressing the center room lamp switch turns on the center room lamp. Pressing the switch again turns off the center room lamp. The center room lamp comes on when the door is opened regardless of the center room lamp switch operation if the door coupled switch is pressed in.

Caution

- The battery may be depleted if a door is left open for an extended period of time with the door coupled switch pressed in.

Sun visor/mirror lamp

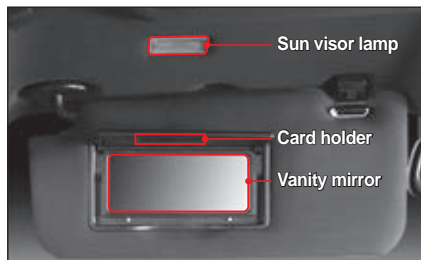

When you pull the sun visor down and open the mirror cover, the lamp turns on.

When you close the mirror cover, the lamp turns off.

Caution

- Be sure to close the mirror cover after using the sun visor mirror. Failure to do so may cause the sun visor lamp to stay on and the battery may be depleted. Also, an open mirror cover may cause injury.

Notice

- When you pull the sun visor down and use it as a sunshade, you can adjust the position of the sun visor.

Door courtesy lamp (front seats)



When you open the door, the lamp turns on, and when you close the door, the lamp turns off.

Mood lamp*

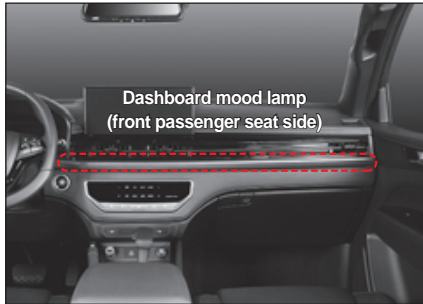

Mood lamps are always activated when any door is open, the ignition is turned on, or switch is turned on, as long as they are set to on.

When the tail light is activated, the mood lamps gradually decrease in brightness to emit a subtle glow.

Glove box lamp



When you open the glove box, the lamp turns on, and when you close the glove box, the lamp turns off.

Caution

- **Leaving the glove box opened may cause injury to an occupant in the event of an accident or sudden braking. Be sure to drive the vehicle with the glove box closed.**

Wiper and washer fluid

Windshield wiper

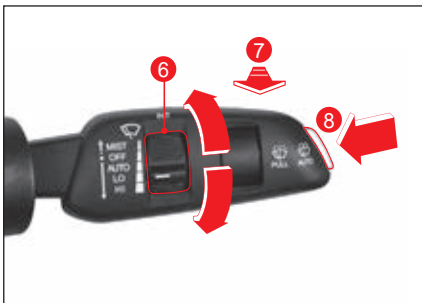
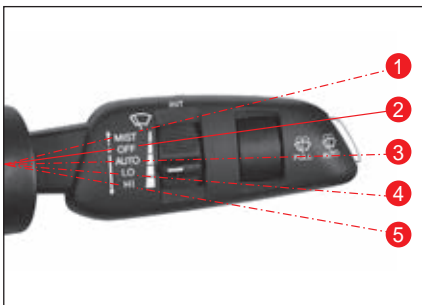

1 MIST

The wiper operates while lifting the wiper operation lever up.

When you release the lever, the level returns to the OFF position and stops.

2 OFF

The wiper stops operating.

3 AUTO

The wiper operation speed is adjusted automatically according to the vehicle speed or the amount of rain (rain sensing wiper).

4 LO

The wiper operates in low speed.

5 HI

The wiper operates in high speed.

Adjusting the operation speed of the windshield wiper

When the wiper operation lever is placed in the AUTO position, the operation speed of the wiper is adjusted.

When you lift the wiper operation speed control lever (6) up, the operation speed of the wiper becomes faster and when you pull the lever down, the operation speed of the wiper becomes slower.

Notice

- When you place the wiper operation lever in the AUTO position with the START/STOP switch in the ON status, the wiper operates once.
- When it becomes dark so that the auto light operates, the wiper speed becomes faster.

Front windshield and washer fluid linkage



This function sprays washer fluid automatically when the windshield wiper is operated.

It operates as follows according to the time to pull the wiper operation lever (7).

- Pull the lever for less than 0.6 second
The washer fluid is sprayed and the wiper operates once.
- Pull the lever for 0.6 second or more
The washer fluid is sprayed and the wiper operates for three times.
- Pull the lever continuously
The washer fluid is sprayed and the wiper operates continuously.

Front auto washer

With the wiper lever placed in the OFF position, press the Front auto washer switch (8).

The washer fluid is sprayed and the wiper operates for four times, and the washer fluid is sprayed again and the wiper operates for three times.

Rain sensing wiper*

The rain sensing wiper detects the amount of rain and controls whether or not to operate the windshield wiper and its operation speed automatically.

The rain sensing wiper is activated when the wiper operation lever is placed in the AUTO position.

Rain sensor

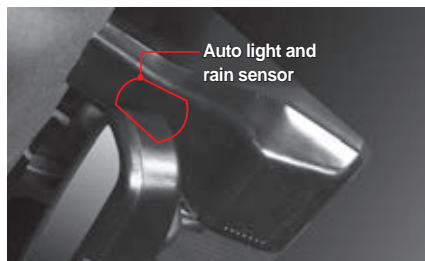

The rain sensor is integrated with the auto light sensor.

Warning

- When you place the wiper operation lever in the AUTO position with the START/STOP switch in the ON status, do not touch the windshield where the rain sensor is located or wipe it with damp cloth. Doing so may activate the rain sensing wiper, causing injury to your hand or other body parts.



Caution

- If the windshield is dry, do not only operate the wiper. Doing so may damage the windshield or the wiper blade. Be sure to activate the wiper after spraying the washer fluid.
- Before washing your vehicle, be sure to place the wiper operation lever in the OFF position. Failure to do so may activate the wiper by accident, causing body injury or damage to the vehicle.
- If it is not raining, place the wiper operation lever in the OFF position. It prevents the devices such as the rain sensor from operating unnecessarily.
- Activate the wiper in winter after verifying that the wiper blade is not frozen. Failure to do so may damage the windshield or the wiper blade.

Outside rearview mirror

Folding/unfolding the outside rearview mirror



- When you press the left side of the button (, the outside rearview mirror is unfolded.
- When you press the right side of the button (, the outside rearview mirror is folded.

Auto folding/unfolding function

The following is the function to fold or unfold the outside rearview mirror automatically.



- When the door Lock/Unlock button on the smart key is pressed
- When the door handle Lock/Unlock button is pressed
- When the smart auto door lock function is activated
- When the auto approach function is activated

Activating/deactivating auto folding/unfolding function

- Activating the function

Place the Outside rearview mirror folding/unfolding button in the neutral () position.

- Deactivating the function

Press the left side () or right side () of the outside rearview mirror.

Caution

- **The outside rearview mirror auto folding/unfolding function is activated only when the vehicle has entered the theft monitoring mode.**

Adjusting the outside rearview mirror



- ① Outside rearview mirror selection dial (L R)
- ② Outside rearview mirror control switch ()

Selecting the outside rearview mirror

Turn the selection dial (①) to the left or the right and select a mirror you wish to adjust.

- Turning to the left: The outside rearview mirror on the driver seat side is selected.
- Turning to the right: The outside rearview mirror on the front passenger seat side is selected.

Adjusting the angle of the outside rearview mirror

Adjust the angle of the mirror according to the driver's view by moving the Control button (②) up, down, left, or right.



Warning

- Do not tint the driver seat and the front passenger seat windows. Doing so may make the outside rearview mirror less visible while driving at night, causing an accident.



Caution

- The outside rearview mirror can be folded or unfolded for a certain period of time after the engine is turned off.
- Do not operate the mirror excessively after the engine is turned off. Doing so may cause depletion of the battery.
- Do not operate the mirror more than needed. When the mirror reaches its maximum adjustment angle, its movement stops, but the motor operates continuously while the switch is being pressed, causing the motor to malfunction.
- Do not operate the outside rearview mirror using hands instead of the motor switch. Doing so may cause the mirror and relevant devices to malfunction.
- Do not spray high pressure water directly onto the mirror while washing the vehicle. The outside rearview mirror operates electrically, so it may not operate normally due to an electrical device failure.

- If the mirror is frozen and does not move during winter, do not adjust it forcibly. Adjust the mirror carefully after removing ice by using deicing spray or soaking a soft cloth or sponge in warm water and wiping the frozen part with it.
- Do not scrape ice off even if the surface of the mirror is frozen during winter. Doing so may damage the surface of the mirror.

Interior mirror

The inside rearview mirror can be adjusted up, down or side ways to obtain the best rear view.

ECM room mirror*

The ECM (Electronic Chromic Mirror) room mirror detects a light from a following vehicle automatically through the light sensor and lowers the reflection rate of the mirror to prevent glare for the driver.

- To adjust the angle of the interior mirror, hold and move the body of the mirror with your hand up, down, left and right to obtain the best rear view.





Warning

- Be sure to finish adjusting the mirror before driving.
- Never adjust the mirror while driving. Doing so may distract the driver, causing an accident.
- If the interior mirror is broken, the electrolyte inside the mirror may flow out. Be careful not to allow this electrolyte come into contact with your skin or eyes. If the electrolyte comes into contact with your eyes, wash it with water immediately and consult a doctor.



Caution

In any of the following cases, the automatic anti-glare function of the ECM room mirror may not operate.

- If the head light of a following vehicle is not beamed directly to the light detection sensor
- When the rear window is tinted darker
- If the gear shift lever is in the R(Reverse) position

At this time, the automatic anti-glare function is suspended to enable easy identification of an object.

Manual type inside rearview mirror



The inside rearview mirror can be adjusted up, down or side ways to obtain the best view by holding the body of the mirror with your hand.

Manual Day/Night Adjustment (A)

You can manually adjust the rearview mirror by pushing or pulling its adjusting lever to avoid blindness at night due to other vehicles behind you.



Warning

- For your safety, adjust the mirror before driving off the vehicle.



Caution

- When you are not able to see the back of your vehicle at night, adjust the rearview mirror by holding the mirror body and pushing or pulling it to a desired angle so that you can secure a clear rear view.

Heater and air conditioner*



- ① Heater and A/C control
- ② Vent center air outlet
- ③ Vent side air outlet
- ④ Sun sensor
- ⑤ Rear vent air outlet
- ⑥ Front foot air outlet
- ⑦ Rear foot duct (Bottom of front seat)
- ⑧ Defroster center air outlet
- ⑨ Defroster side air outlet
- ⑩ Interior temperature sensor

Adjusting the direction of air distribution and fan speed

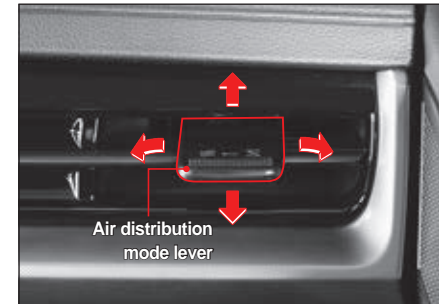

- Adjust air distribution
You can adjust the direction of air distribution by moving the air distribution mode lever up, down, left and right.
- Open and close air vents
If you push the air distribution mode lever all the way to the closing (☒) direction, the air vent closes and the air does not come out. If you put it in the opening (≡) direction, air comes out.

Caution

- Do not attach a cup holder or other devices to the air guide pin of the air outlet. Doing so may damage the air guide pin or other relevant devices.

Cautions for using the heater and air conditioner

Replacing A/C refrigerant/oil

Be sure to replace the A/C refrigerant and oil with the products that meets the specified standard and capacity. Failure to do so may damage the air conditioner system.

Item	Type A	Type B
Specification	R-1234yf	R134a
Capacity	Single A/C	
	520 ± 30g	550 ± 30g
Oil capacity	160cc	160cc



Warning

- While driving, select the fresh air mode if possible or open the window and ventilate frequently to allow fresh air to flow in. Failure to do so may make the air inside the vehicle to be stuffy, causing headache or dizziness.
- Caution should be taken that if exhaust gas flows in, it may cause carbon monoxide poisoning.
- When you drive in an area where dust and smoke may flow in, pass the area using the recirculation mode and switch it to fresh air mode for ventilation.
- Do not sleep or stay inside the vehicle for a long period of time while operating the air conditioner or the heater with the doors and the windows closed during midsummer or midwinter. Doing so may cause suffocation due to lack of oxygen inside the vehicle.
- Never leave an infant, a small child or an elderly alone in the vehicle even for a short period of time during midsummer. The temperature inside the vehicle may increase, causing risks such as suffocation.
- Refrigerant is flammable which can cause the fire by the gas leakage or static, so be very careful when handling Refrigerant (R-1234yf).



Caution

- Before driving the vehicle, open all windows to ventilate the air inside the vehicle properly for the health of occupants and a pleasant indoor environment. Especially, if the vehicle has been parked on a place exposed to direct sunlight for a long period of time, the temperature inside the vehicle may have increased, causing volatile organic compounds that are harmful to human body to be emitted.
- Do not start the engine while electrical devices with high electrical load such as the air conditioner and fan are running. In such case, it may be difficult to start the engine and the engine idle speed becomes unstable after the engine is started so that you may feel vibration greater than usual.
- When you drive up on a long sloping road continuously, turn on and off the air conditioner every 3 to 5 minutes. Failure to do so may overheat the engine, causing a failure.
- When you apply a sudden acceleration while the air conditioner is operating, the magnetic clutch in the compressor is detached and may create a clicking sound. This is a normal operation that lowers excessive pressure of the refrigerant to protect the air conditioner system.

- Be sure to operate the air conditioner at a low speed if you use the air conditioner again after it is not used for a while. If the air conditioner is not used for a long period of time, the oil in the compressor is not circulated, causing a failure.
- When you use the air conditioner after it is not used for a long period of time, there may be a smell from the air outlet. In such case, open the window and operate the air conditioner for 20 to 30 minutes to eliminate the smell.
- Do not turn off the engine suddenly while operating the air conditioner. The fan motor stops suddenly and cold or warm air in the duct is condensed in the pipe without being emitted to the outside, creating a bad smell. Before turning off the engine, turn off the air conditioner and emit air in the duct for 2 to 3 minutes in the fresh air mode.
- Do not operate the air conditioner for a long period of time while stopping the vehicle. Doing so may overheat the engine, causing a failure.
- If the engine is not running, do not operate the fan for a long period of time. Doing so may cause depletion of the battery.
- Operate the air conditioner once a week in seasons other than winter to circulate the oil in the air conditioner compressor and relevant parts smoothly. This helps you to maintain the air conditioner in its best condition.

Heater and A/C controller*

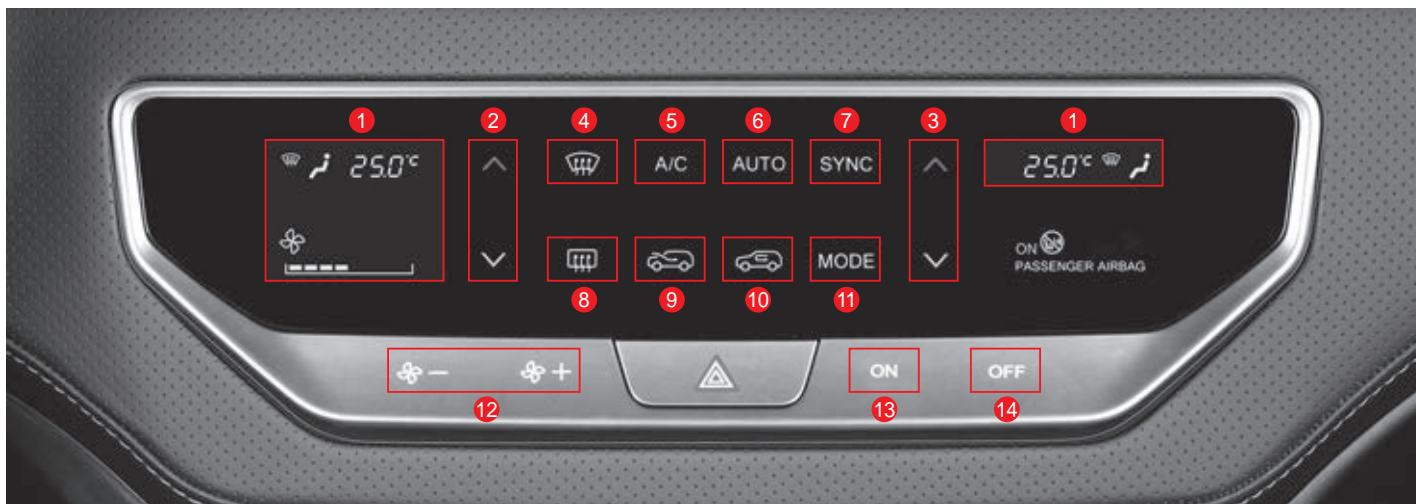

- | | | |
|---|--|---------------------------------|
| 1 Operation indicator display | 7 SYNC switch (to sync with driver side set temperature) | 11 Air distribution mode switch |
| 2 Driver side temperature control switch | 8 Glass heater switch | 12 Air volume control switch |
| 3 Passenger side temperature control switch | 9 Fresh air mode switch | 13 Heater and A/C ON switch |
| 4 Defroster switch | 10 Air recirculation mode switch | 14 Heater and A/C OFF switch |
| 5 A/C switch | | |
| 6 AUTO switch | | |

Turning Heater & A/C ON/OFF

- To turn the heater and air conditioner on, lightly touch the ON switch (1).
(In this case, its symbol changes to orange.)
- To turn the heater and air conditioner off, lightly touch the OFF switch (2).
(In this case, its symbol changes to orange.)



Notice

- The heater and air conditioner will operate as previous operation condition when they are turned on.
- When the heater and air conditioner are off, touch the relevant operation switch to turn them on.

Driver/Passenger Side Temperature Control

To adjust the temperature, lightly touch the driver/passenger side temperature control switch (1).

- The set temperature is displayed on the operation display (2).
- When the driver's seat set temperature synchronization (SYNC) indicator (3) is lit (shown in orange), the driver's seat and the passenger seat's set temperature are changed equally.
- When the temperature control switch is operated, the increment values are:
 - 0.5°C on long touch.
 - 0.5°C on short touch.



Notice

- Touching the AUTO switch in manual mode changes the climate control system to AUTO mode and the climate functions are controlled automatically based on the set temperature.

Independent Temperature Control (SYNC Off)

To independently adjust the set temperature for the driver's seat and front passenger's seat, operate as follows.

- Turn off the synchronization indicator (lit in white) (3) by lightly touching the driver's seat temperature synchronization (SYNC) switch and the front passenger temperature control switch.
 - Synchronization indicator (SYNC) on: shown in orange
 - Synchronization indicator (SYNC) off: shown in white

Temperature Synchronization Control (SYNC On)

Lightly touch the driver's seat set temperature synchronization (SYNC) switch to turn on the synchronization light (shown in orange) (3). Then the set temperature of the passenger seat will follow the one of the driver's seat.

Notice

- Air conditioner ON/OFF, direction of air distribution, recirculation mode or fresh air mode are set automatically according to the set temperature of the driver seat.
 - If the set temperature is a low temperature (LO): Air conditioner ON, direction of air distribution towards face and recirculation mode
 - If the set temperature is a high temperature (HI): Air conditioner OFF, direction of air distribution towards foot and fresh air mode

AUTO Mode

To enter AUTO mode, operate as follows with the engine started.

- Briefly touch the AUTO switch (1).
 - AUTO mode on: shown in orange
 - AUTO mode off: shown in white
- Set the desired temperature by lightly touching the temperature control switch (2).





Notice

- In AUTO mode, the fan speed, air distribution and etc. are automatically adjusted according to the set temperature, room temperature, and outside temperature.
- Touching the air source selection switch, fan speed switch, air distribution mode switch, A/C switch, or defroster switch in auto mode deactivates the auto mode and the system enters the manual mode.

Manual Mode

Operate as follows with the engine started.

- Touch the ON switch (1).
- Set the room temperature by lightly touching the temperature control switch (2).
 - The currently set temperature is displayed (3).
- Lightly touch the fan speed switch - (decrease fan speed) / + (increase fan speed) (4) to set the fan speed one step at a time.
 - The current fan speed is displayed on the operation display (5).
- Lightly touch the air distribution mode switch (6) to select the desired air distribution mode. There are 4 air distribution modes available as follows:
 - Face
 - Face + footwell
 - Footwell
 - Windshield + footwell
- Select the recirculation mode/fresh air mode by touching the recirculation switch (7) or fresh air switch (8).
 - Recirculation mode: 
 - Fresh air mode: 
- To use the air conditioner, lightly touch the air conditioner switch (9).



Warning

- Do not use the recirculation mode longer than is needed. Doing so may cause headache or drowsiness due to lack of oxygen inside the vehicle. Also, moisture may occur on the window, impairing safe visibility and may result in an accident.
- Be careful not to allow exhaust gas to flow into the inside of the vehicle. Doing so may cause carbon monoxide poisoning.
- Pass an area where dust and smoke may flow in using the recirculation mode. After that, switch the mode to the fresh air mode for ventilation.

Notice

- Touching the AUTO switch lightly in manual mode changes the climate control system to AUTO mode and the climate functions are controlled automatically based on the set temperature.

Air Distribution

Lightly touch the air distribution mode switch (1) to select the desired air flow direction.

The selected air distribution mode is displayed on the operation display (2).



1



Air distribution towards the windshield and door windows
When you press the Defrost and defog switch, the mode is switched to the fresh air mode automatically and the air conditioner is turned on.

2



Air distribution towards face (default setting for cooling)

3



Air distribution towards face and foot

4



Air distribution towards foot, windshield and door windows

5



Air distribution towards foot (default setting for heating)

Notice

- If the direction of air distribution is set to foot, a little bit of air comes out towards the windshield and door glass to prevent the occurrence of moisture on the windshield.

Activating glass heater

When frost or fogging occurs in the window, the glass heater can be activated to remove it.

- To activate the glass heater, lightly touch the glass heater switch (1). (The glass heater operates for about 12 minutes and the switch symbol changes to orange.)
- To deactivate the glass heater, lightly touch the glass heater switch (1) again. (The glass heater stops working and the switch symbol changes to white.)



Rear window heater



Outside rearview mirror heater

Notice

- The glass heater only operates while the engine is running.
- When the glass heater is activated, the rear window heater and the outside rearview mirror heater are operated simultaneously.
- To operate the glass heater again within 10 minutes after it is operated for 12 minutes, the glass heater operates only for approximately 6 minutes.

How to Dehumidify Window Glass

- 1 Lightly touch the defroster and defogger switch (1).
(The symbol changes to orange.)
The operation display shows  icon.
- 2 Lightly touch the fan speed switch - (decrease fan speed) / + (increase fan speed) (2) to set the fan speed.
(The current fan speed is displayed (3).)
 - To quickly remove moisture from the windows, set the fan to high speed.
 - To defrost the outdoor side window, set the temperature to high.

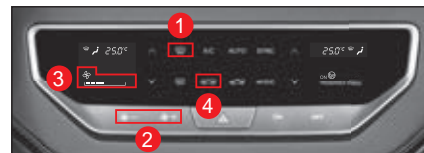

Note

- Touching the defroster and defogger switch (1) activates the air conditioner automatically and sets it to fresh air mode and fan speed of 6th level. Touching the switch again returns the system to previous condition.
- To prevent the windshield from fogging up at normal driving, it is recommend to set to the fresh air mode (4).



Warning

- If it is raining or humid, switch to the fresh air mode and set the air distribution to the windshield. With rainy or highly humid condition, fog may appear on the windows as well as the windshield even the A/C is ON. If this happens, it is dangerous to drive because of poor frontal and side visibilities.



Caution

- If the defrost and defog function is turned on and the direction of air distribution is set to foot or foot and the windshield, do not operate the air conditioner excessively. Doing so may cause moisture to occur on the outside surface of the windshield due to a temperature difference between the inside and outside of the vehicle. In such case, quickly remove the moisture on the outside surface of the windshield using the wiper and switch the direction of air distribution to the face to reduce the moisture occurrence on the outside surface of the windshield.
- Be sure to remove foreign materials (snow, fallen leaves, etc) from the air inlet during winter and summer to prevent the occurrence of moisture on the glass.

Auto defogger system

The auto defogger system is an auxiliary device that removes mist from the inside surface of the windshield automatically when it is detected, enabling safe driving.

Auto Defogger System

In the InfoCon navigation system, ADS (Auto Defogger System) is an auxiliary device that enables safe driving by automatically removing fog when fog is detected on the indoor windshield while the heater and A/C are in operation. To use this function, you must enable the automatic defogger ("Check" under Vehicle Settings → Defogging → Auto Defogger).

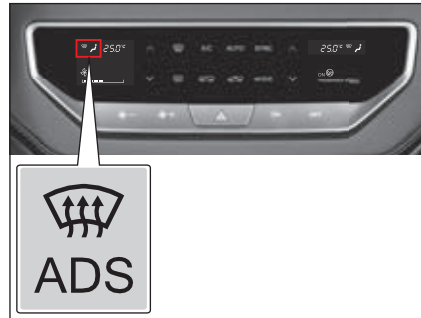

Operation levels of auto defogger system

As the humidity on the inside surface of windshield becomes higher, the auto defogger system operates at a high level. For example, if the humidity cannot be controlled by switching to the fresh air mode that is level 1, the operation is carried out from level 2 to level 4 in consecutive order to control the humidity.

- Level 1 - Switch to the fresh air mode
- Level 2 - Air conditioner ON
- Level 3 - Air distribution towards the windshield
- Level 4 - Increase the fan speed towards the windshield



Warning

- Do not switch the mode to the recirculation mode while the auto defogger system is operating. Doing so may decrease the moisture removal effect, impairing safe visibility and may result in an accident.
- Do not remove the sensor cover on top of the windshield forcibly. Doing so may damage the auto fog detection sensor.

Eco Mode

This is a function that maintains the air source selection mode to recirculation mode for 20 minutes when the vehicle is started, in order to quickly lower the vehicle's cabin temperature during hot weather.

Conditions for activation

- Air source selection: fresh air mode
- Ambient temperature: 24°C or higher
- A/C status: ON



Caution

- **The vehicle enters eco mode only once upon starting, with the above operating conditions met.**
- **When the A/C is changed to the fresh air mode with the eco mode activated, the eco mode is deactivated.**
- **After 20 minutes of eco mode (recirculation mode) operation, the air source selection changes to the state before eco mode is activated.**

Heater and A/C controller (manual)



- ① Blower Switch
- ② Front Temp up/down Switch
- ③ Mode D/F Switch
- ④ Rear DEF Switch

- ⑤ Mode Switch
- ⑥ System Off
- ⑦ Recirculation Air Switch
- ⑧ Fresh Air Switch

- ⑨ MAX A/C Switch
- ⑩ A/C Switch

Setting/operating the heater and air conditioner

Operate as follows while the engine is running.

- Adjust with the fan speed switch (1).
- Adjust the temperature with the temperature control switch (2).
- Select the desired direction of air distribution by pressing the Air distribution mode button (5).
- Select the recirculation mode or the fresh air mode by pressing the Recirculation/fresh air switch button (7, 8).
- If you wish to use the air conditioner, press the Air conditioner switch (6).

The operation indicator turns on or off each time you press the switch or the button.



Warning

- Do not use the recirculation mode longer than is needed. Doing so may cause headache or drowsiness due to lack of oxygen inside the vehicle. Also, moisture may occur on the window, impairing safe visibility and may result in an accident.

Notice

- If the Air conditioner switch (10) is not pressed, the air conditioner is not activated even if the fan speed control switch (1) is operated. However, only air is provided by the fan operation.

Controlling the fan speed (1)



- Press the fan speed up or down switch to adjust the speed.

Controlling the temperature (2)



- Press the temperature up or down switch to adjust the temperature.

Defrosting and defogging (3)

- Pressing the Defrost and defog switch turns on the operation indicator and the direction of air distribution is changed to the windshield and door glass. At this time, the air conditioner is activated, switching the mode to the fresh air mode.
- To turn the defrost and defog function off, press either the Air distribution mode button or Max A/C switch.



Switching between recirculation mode and fresh air mode (7, 8)

- Pressing the Recirculation/fresh air switch turns on the operation indicator and the mode is switched to the recirculation fresh mode.



Warning

- Do not use the recirculation mode longer than is needed. Doing so may cause headache or drowsiness due to lack of oxygen inside the vehicle. Also, moisture may occur on the window, impairing safe visibility and may result in an accident.
- Be careful not to allow exhaust gas to flow into the inside of the vehicle. Doing so may cause carbon monoxide poisoning.
- Pass an area where dust and smoke may flow in using the recirculation mode. After that, switch the mode to the fresh air mode for ventilation.

MAX A/C switch (9)

If the Max A/C switch is pressed while the heater and the air conditioner are operating, the system operates as follows.

- Operate the air conditioner
- Switch to the recirculation mode
- Switch the direction of air distribution to face
- Operate at the lowest temperature







Selecting the direction of air distribution (5)

Press the Air distribution mode switch in the desired direction.

The operation indicator turns on.



1 	Air distribution towards foot, windshield and door windows
2 	Air distribution towards face (default setting for cooling)
3 	Air distribution towards face and foot
4 	Air distribution towards foot (default setting for heating)

Notice

- If the direction of air distribution is set to foot, a little bit of air comes out in the direction of windshield and door glass to prevent the occurrence of moisture on the windshield.

Operating the glass heater (4)

If the glass is covered with frost or mist, you can remove the frost or mist by operating the glass heater.

- To operate the glass heater, press the Glass heater switch. The operation indicator turns on and the glass heater operates for approximately 12 minutes.
- To stop the glass heater operation, press the Glass heater switch again. The operation indicator turns off and the glass heater operation stops.



Rear window heater



Outside rearview mirror heater

Notice

- The glass heater only operates while the engine is running.
- When you operate the glass heater, rear glass and outside rearview mirror operates at the same time.
- To operate the glass heater again within 10 minutes after it is operated for 12 minutes, the glass heater operates only for approximately 6 minutes.

Removing moisture on the glass

- 1 Press the Defrost and defog switch (3).
The operation indicator turns on.
- 2 Turn the fan speed control switch (1) to a position other than OFF.
 - To remove moisture on the glass quickly, set the fan speed to high.
 - To remove frost or mist on the outside surface of the glass, set the temperature to high.



Notice

- When you press the Defrost and defog switch (1), the air conditioner is activated automatically and the fresh air mode and level 1 fan speed or faster are set. When you press the switch again, the system returns to its original condition.
- In order to prevent moisture occurrence on the glass generally, it is recommended to set the Recirculation/fresh air switch button (8) to the fresh air mode.

Warning

- If it rains or the humidity is high, switch the Recirculation/fresh air switch to the fresh air mode and set the direction of air distribution to the windshield. If it rains or the humidity is high, moisture may occur on the windshield as well as other windows even if the air conditioner is turned on. This may lead to poor front, side and rear visibility that can result in a very dangerous situation.

Caution

- If the defrost and defog function is turned on and the direction of air distribution is set to foot or foot and the windshield, do not operate the air conditioner excessively. Doing so may cause moisture to occur on the outside surface of the windshield due to a temperature difference between the inside and outside of the vehicle. In such case, quickly remove the moisture on the outside surface of the windshield promptly using the wiper and switch the direction of air distribution to the face to reduce the moisture occurrence on the outside surface of the windshield.
- Be sure to remove foreign materials (snow, fallen leaves, etc) from the air inlet during winter and summer to prevent the occurrence of moisture on the glass.

Steering wheel

Adjusting the height/length of the steering wheel

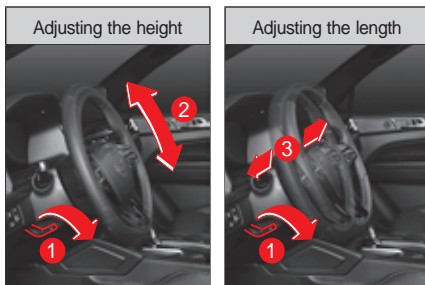

- 1 Push down the steering wheel telescoping/tilt control lever (1).
- 2 Adjust the position of the steering wheel upwards and downwards (2) and forwards and backwards (3) properly.
- 3 Lift the steering wheel telescoping/tilt control lever (1) up.

After adjusting the steering wheel, check that the steering wheel is secured firmly.

Warning

- Check that the steering wheel is secured firmly before driving.
- Do not adjust the steering wheel while driving. Doing so may cause a serious accident.

Caution

- Do not turn the steering wheel left or right to the end and maintain such position for 10 seconds or more with the engine started. Doing so may damage the power steering system due to overload.
- In winter (-10°C or below), starting off the vehicle immediately after starting the engine while the power steering fluid is cold can sometimes cause a momentary delay in the power steering, so be sure to let the engine idle properly before starting.

Steering wheel heater*



- To activate the steering wheel heater, press the steering wheel heater switch while the engine is running.
The operation indicator on the instrument cluster turns on.

- To deactivate the Steering wheel heater, press the Steering wheel heater switch again.
The operation indicator on the instrument cluster turns off.

Caution

- Do not attach an assist knob to the steering wheel. Doing so may damage the heater in the steering wheel and impede safe steering.

Notice

- The status of the Steering wheel heater switch is maintained even if the engine is turned off and on again.

Horn

Warning horn is sounded while the horn is being pressed.

Caution

- Using the horn may startle pedestrians. Use it carefully only when it is necessary.

Infotainment system*

Smart audio

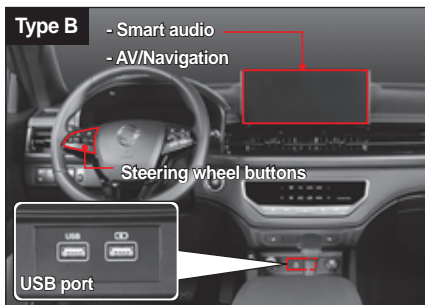
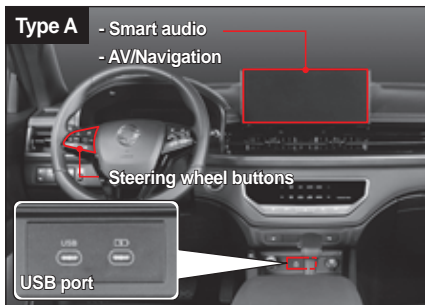

! Caution

- The Android auto and Car Play in the vehicle may not be supported or some functions may not be compatible according to the specification or characteristics of the relevant device.
- The connection of the relevant devices to the vehicle may not be supported or some functions may not be compatible according to the specification or characteristics of the relevant video player, MP3 player or CD player.
- The method of use may be different or the connection to the vehicle may not be supported according to the specification or characteristics of the relevant Bluetooth device.
- Some USB storage devices and SD cards may not be compatible with the relevant device in the vehicle. Using a non-compatible memory card may damage the relevant device in the vehicle, memory card or data saved in the memory card.

Notice

- For detailed explanation regarding the infotainment system in the vehicle including smart audio, AV/Navigation and slots for multimedia, refer to the owner's manual provided separately.
- If you wish to connect an external device to the infotainment system in the vehicle including smart audio, AV/Navigation and slots for multimedia, refer to the owner's manual of the relevant device for how to connect and use such device.

- You can operate the smart audio using the 8-inch touch screen and the steering wheel buttons.
- An external device can be connected to the slots for multimedia using the USB port (iPod, iPhone and iPad are supported).
- Android auto (Android devices are supported) and Car Play (iPhone is supported) as well as Bluetooth, rear camera and around view camera are supported.

The operation information of the smart audio is displayed on the instrument cluster.

! Caution

- Do not use the audio system for a long period of time with the engine not started. Doing so may cause depletion of the battery in the vehicle.

MP3 audio system

For detailed information regarding the audio system, refer to the User manual provided by the audio manufacturer.

With USB and iPod supporting functions, this audio system can be controlled by using both audio switches and steering wheel switches.

Notice

- **The MP3 audio system supports the iPod function through the USB port.**

- The iPod models that can be connected to the audio are Nano, iPod, iPod Touch, I-Phone and so on.
- This audio system may not support some of the iPod/iPhone products. Always use the connecting cable provided with the iPod product when connecting it to the audio system. Other cables may not be compatible and cause the audio system to fail.
- The iPod product cannot be charged using the connecting cable.

AV/Navigation

- You can operate the AV/Navigation on the 9-inch touch screen and the steering wheel buttons (voice recognition function is supported).
- An external device can be connected to the slots for multimedia using the USB port (iPod, iPhone and iPad are supported).
- Android auto (Android devices are supported) and Car Play (iPhone is supported) as well as Bluetooth, SD card (for navigation), rear camera and around view camera are supported.

The operation information of the AV/Navigation is displayed on the instrument cluster.

Warning

- **Be sure to use the navigation and video-related functions after stopping or parking the vehicle at a safe place for safe driving.**

Caution

- **Do not use the AV/navigation system for a long period of time with the engine not started. Doing so may cause depletion of the battery in the vehicle.**

Slots for multimedia

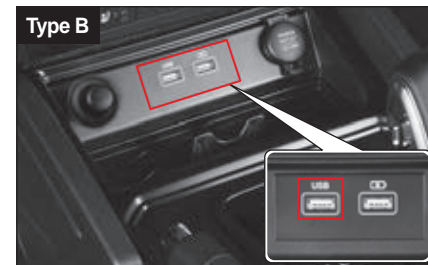
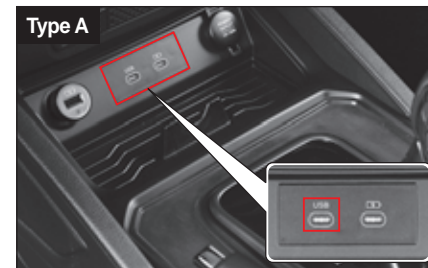

A USB storage device, an external music and video player such as iPod/iPhone/iPad, an MP3 player can be connected to the vehicle through the USB port.

Caution

- **Some USB storage devices and external music/video players may not be played through the USB port.**

Operating from the steering wheel



- 1 Voice recognition button
- 2 Volume control lever
- 3 Bluetooth hands-free button
- 4 Mute button
- 5 Mode selection button/
Media search (SEEK) lever

Voice recognition function

This convenient function allows you to use various functions of the infotainment system through voice recognition.

- In Apply Car play mode
- operates Siri
- In Android Auto mode
- operates Google Voice

Controlling the volume

Raises or lowers the volume.

Bluetooth hands-free

You can connect and use your mobile phone in the vehicle through Bluetooth.

Notice

- For detailed explanation regarding the Bluetooth hands-free, refer to the owner's manual provided separately.

Mute

- Tapping the Mute button with the audio system turned on turns off the voice output. Tapping it again turns on the voice output.
- Pressing and holding down the Mute button with the audio system turned on turns off the audio system.

MODE Selecting the mode

- The AV mode changes each time you press the Mode button.
- Tapping the Mode button with the AV system turned off, turns on the AV system.

^
SEEK Searching for media (SEEK)
v

Classification	Tap up/down the SEEK lever	Push up/down and hold the SEEK lever
When playing on the media screen	Plays the previous/next track	Moves to the previous/next list of tracks (The current playback is maintained)
When playing on a screen other than the media screen	Plays the next/previous track	Moves to the next/previous list of tracks (The current playback is maintained)
When listening in the radio screen	Moves to the previous/next saved channel	Moves to the next/previous available radio frequency
When listening in screens other than the radio screen	Moves to the next/previous saved channel	

Antenna*

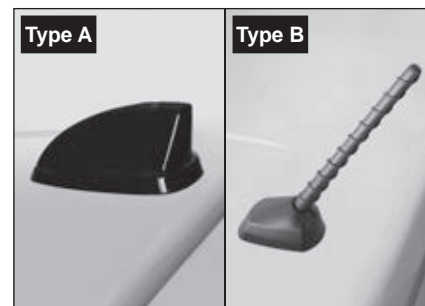

If the audio system is turned ON, the antenna receives the following radio waves.

Type A

- For vehicles with smart audio: GPS (GNSS), Radio signal, DAB (EU)
- For vehicles with AV/Navigation: GPS (GNSS), Radio signal, DAB (EU)

Type B

- For vehicles with MP3 audio : Radio signal

Power socket

Front



An auxiliary power outlet for extra electrical devices is installed. This power outlet supplies power when the ignition key is in the “ACC” or “ON” position.

Warning

- For the extra electrical devices, you must use this power outlet. If you alter the vehicle's wire lines and leave the wires to hang freely, it could cause an accident like a fire.
- Abide by the nominal capacity of 12V-120W.
- Do not put a finger into the outlet. It may cause an electric shock.
- The battery can be discharged if the power outlet is used excessively when the engine is not running.

Caution

- Keep the power outlet cover closed if not in use. Electrical defects can occur if objects other than power outlet plugs or water gets in. This will prevent the socket from becoming clogged or short circuiting.

Cigarette lighter*



To operate the cigarette lighter, press it in all the way down. When it becomes heated, it automatically pops out and is ready for use.



Warning

- When the cigarette lighter does not automatically pop up after 30 seconds, there is a danger of overheating. If this happens, pull it out and have the problem corrected by KG Mobility Dealer or KG Mobility Authorized Service Center.
- Inserting your finger into the cigarette lighter outlet can cause burns or electric shock.
- The barrel of the cigarette lighter becomes very hot when it is fully charged. When touched by or dropped on bare skin, this may cause burns. Dropping the hot lighter can cause damage to a car seat or even start a fire.
- Use only the genuine cigarette light in the cigarette lighter shock. To prevent from electrical damage and fire, never use any other electric device such as shaver, vacuum cleaner or coffee pot.



Caution

- Do not tap the cigarette lighter strongly to clean up. That may damage the coil.

USB charging port

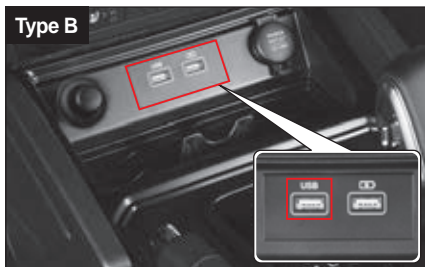
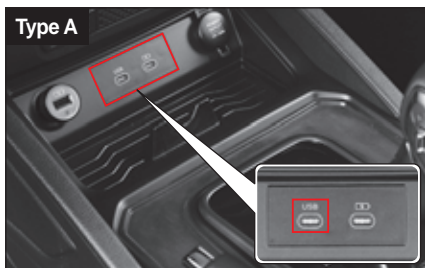

You can charge devices such as a smartphone or tablet PC using the USB charging port.

- In order to charge, connect the charging cable of the device to charge to the USB charging port in front side of the front seat cup holder with the engine started.
- With the engine turned on, connect the charging cable of a device you wish to charge to the USB charging port at the rear side of the central console.
- For charging complete and charging progress, refer to the display screen of the device being charged.

Type A	5V/2.9A, 27W
Type B	5V/2.1A, 10.5W

Caution

- Connect a device you wish to charge to the USB charging port after starting the engine and separate the device before turning off the engine. Failure to do so may damage the device being charged by sudden voltage variation when starting or turning off the engine.
- Caution should be taken that using the USB charging port with the engine turned off may cause depletion of the battery.
- Do not charge a device whose current consumption exceeds 2.9A with the USB charging port. Doing so may disable charging, making the charging time longer or damage the USB charging port and the connected device.
- Caution should be taken that connecting the USB charging cable incorrectly may damage the fuses in the vehicle or the connected device due to a short circuit.
- Caution should be taken that if a foreign material or liquid such as water enters into the USB charging port, the charging port and the device may get damaged.

Notice

- The charging speed of the USB charging port may vary depending on the type of and compatibility with the connected device, charging cable and other vehicle conditions.

Indoor convenient equipment

Sun visor and card holder (driver seat)

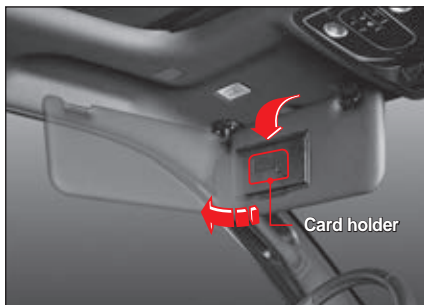

Sun visor

You can block out the sun from the front or the sides by lowering the sun visor.

Card holder

The card holder is provided in the inside cover of the sun visor. It is convenient to store a motorway toll ticket or a card.

Caution

- **Adjusting the sun visor or using the card holder or mirror while driving may lead to careless driving or block the driver's vision, resulting in an accident.**
- **Adjust or use the sun visor and card holder after stopping or parking the vehicle.**

Mirror and lamp

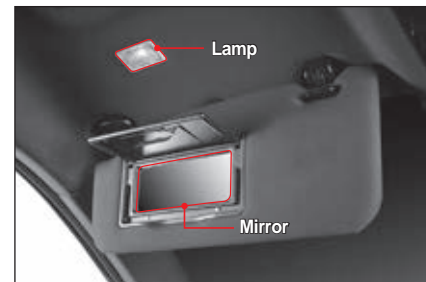

- You can use the mirror by lowering the sun visor and lifting up the cover.
- When you lift up the mirror cover, the lighting lamp turns on.

Caution

- **Be sure to close the mirror cover after using the sun visor mirror. Failure to do so may cause the sun visor lamp to stay on and the battery may be depleted. Also, an open mirror cover may cause injury.**

Grip handle/coat hanger



- The grip handle is installed on the side ceiling of the rear seats (head lining).
- The coat hanger is included in the grip handle on the ceiling of the rear seats.

Warning

- Do not hang articles other than cloth on the coat hanger. Doing so may cause the side air bag to operate at the time of an impact of an accident, resulting in damage to the vehicle as well as the injury or death of an indoor occupant.

Caution

- Do not hang a heavy cloth on the coat hanger. Doing so may damage the coat hanger and the ceiling (head lining).

Front seat side grip handle

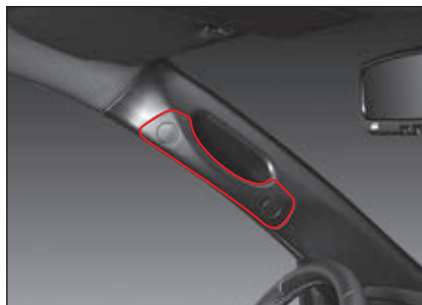

There is the grip handle in front of the seat side to make it easier to get on and off.

Side grip handle on the rear seats



The grip handle is installed at the front of side of rear seats for convenience at the time of getting in and out of the vehicle.

Rear tray*



If you fold the rear seats down, there is a storage box where small items can be stored.

Storage unit

Front seat/rear seat cup holder



The cup holder is provided in front of the central console section.

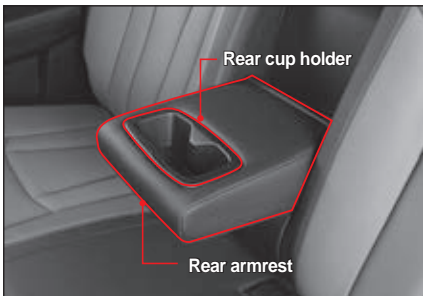

There is a cup holder when you lower the rear seat armrest.



Caution

- Caution should be taken that hot liquid in the cup may overflow or spill, causing a burn.
- Pay particular attention while driving since the cup may fall down or the liquid in the cup may spill over.
- Caution should be taken that if liquid in the cup spills over into the switches or operation buttons, it may cause trouble to the system functions.

Front storage

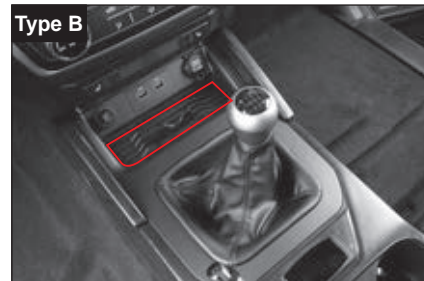
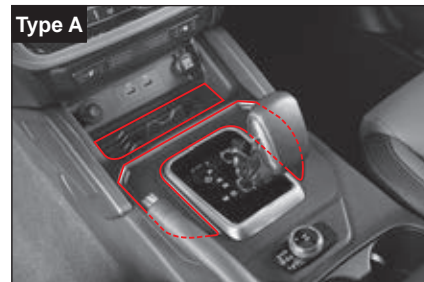

The front storage is provided near the gear shift lever. Use it for storing a small article.



Caution

- Caution should be taken that an article in the front storage may fall down or interrupt the operation of the gear shift lever.

Glove box

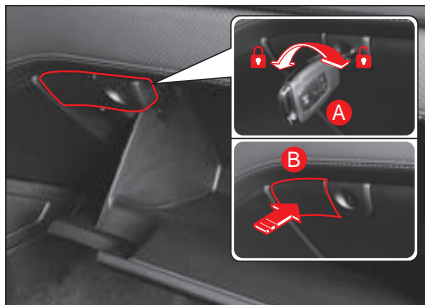

The glove box can be used for storing documents related to the vehicle registration or articles used in the vehicle conveniently.

- The glove box can be locked or unlocked using the emergency key (A).
- Press the button (B) to open the glove box.

! Caution

- Leaving the glove box opened may cause injury to an occupant in the event of an accident or sudden braking. Close the glove box while driving.
- Do not store any flammable materials or a cigarette lighter, etc. in the glove box, console or inside the vehicle. Doing so may cause an explosion during midsummer or the air inside the vehicle is heated.

Notice

- The lamp inside the glove box turns on when you open the glove box with the Light switch of the head light/tail light ON status.

Console



Articles used by occupants can be stored on the console at the front seats and the rear seats conveniently.

! Caution

- Do not store any valuable article on the console for preventing theft.
- Do not store an article that can be damaged easily or creates noise on the console as it may move while driving.
- Do not store any flammable materials or a cigarette lighter, etc. in the console, the glove box, or indoor. Doing so may cause an explosion during midsummer or when the air inside the vehicle is heated.

Door map pocket



The pocket (bottle tray) where books, magazines, water bottles or beverages can be stored is provided.

Seat backrest pocket

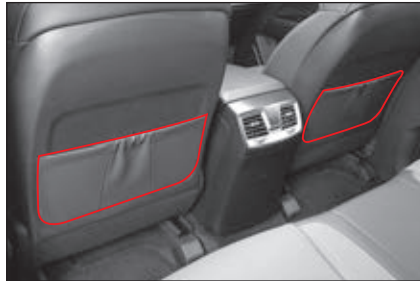

It can be used conveniently for storing magazines or newspapers.



Caution

- Do not store scissors, knives, or other objects with an improper size in the seat backrest pocket. Doing so may cause personal injury in the event of sudden braking or a vehicle collision.

Roof rack*

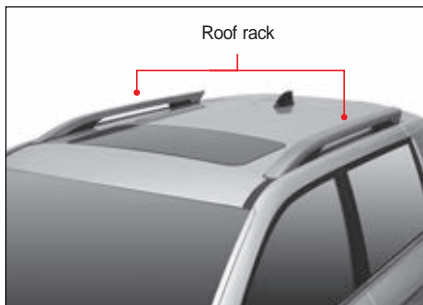

The luggage can be loaded onto the top of the vehicle roof using the roof rack.

Also, leisure sporting goods such as a bicycle, snowboard and skis by installing a separate carrier on the roof rack.

- The maximum loading capacity of the roof rack is 100 kg (220 lbs).

Warning

- The luggage loaded onto the roof rack should not exceed the maximum loading capacity. The luggage loaded onto the roof rack should not stick out of the roof. If the maximum loading capacity is exceeded or the luggage sticks out of the roof rack, the relevant vehicle or other vehicles may be damaged. In addition, it adversely affects the driving stability of the vehicle and may cause an accident while driving.
- Fix the luggage to the roof rack safely, and in case of driving for a long period of time, check the fixing status of the luggage frequently. If the luggage loaded onto the roof rack falls off from the vehicle, other vehicles may be damaged or a pedestrian may get injured. Also, it may cause a bigger accident.
- When luggage is loaded onto the roof rack, the center of gravity of the vehicle becomes higher. If you control the steering wheel suddenly while applying sudden braking, making sharp turn or driving at a high speed, the vehicle may become unstable, causing an accident or overturning of the vehicle.
- If the luggage is loaded onto the roof rack, check the tightening status of roof rack fixing bolts and nuts frequently.
- Drive the vehicle at a low speed if possible when luggage is loaded onto the roof rack.

Caution

- Caution should be taken that if you load luggage onto the roof rack of a vehicle where a sunroof is installed, the luggage should not interrupt the operation of the sunroof.

Notice

- A protective gear such as a cushion or a cloth can be inserted between the luggage and the roof rack in order to prevent the vehicle from being damaged by contact between the luggage loaded onto the roof rack and the vehicle roof.

4. Starting and driving

You can check information regarding the basic equipment for safe driving, auxiliary equipment that helps you to drive comfortably, and how to use such equipment.

An explanation is provided for the START/STOP switch and smart key as well as the driving system including the instrument cluster, gear shift lever, 4WD, cruise control, auxiliary driving systems such as the brake and autonomous emergency braking system, rear and side warning, lane departure warning system, and parking assist system.

Starting the engine and driving the vehicle

Engine starting (REKES)

- 1 Apply the parking brake.
- 2 Make sure that there are no persons or obstacles in the dangerous area around the vehicle.

Caution

- The engine in automatic transmission equipped vehicle can be started only when the gear selector lever is at the “P” or “N” position. The engine in manual transmission equipped vehicle can be started only when the clutch pedal is fully depressed.
- Do not turn the ignition key to the “START” position while the engine is running. It could result in serious start motor damage.

3 * Automatic transmission equipped vehicle

Move the gear selector lever to the “P” position and depress the brake pedal.

* Manual transmission equipped vehicle

Move the gear shift lever to the Neutral position and fully depress the brake pedal and the clutch pedal.

Warning

- Depress the brake pedal when the gear shift lever is at the “P” (A/T) or “Neutral”(M/T) position. Never depress the accelerator pedal.

4 * Gasoline engine equipped vehicle

Insert the ignition key into the key cylinder and turn it to “START” position and hold it there without depressing the accelerator pedal until the engine starts (a maximum of 10 seconds), then release the key.

* Diesel engine equipped vehicle

Insert the ignition key into the key cylinder and turn it to the “ON” position. As soon as the glow indicator (00) goes out, turn it to “START” position and hold it there without depressing the accelerator pedal until the engine starts (a maximum of 10 seconds), then release the key.

Caution

- If the engine fails to start, turn the key back to “LOCK” position and wait for 10 seconds. Then try again before any attempt to start the engine.

- 5 Warm up the engine properly according to the ambient temperature.

Engine starting (Smart key)

- 1 Apply the parking brake.
- 2 Make sure that there are no persons or obstacles in the dangerous area around the vehicle.

Caution

- The engine in automatic transmission equipped vehicle can be started only when the gear selector lever is at the “P” or “N” position.
- Do not press the engine start/stop button while the engine is running. It could result in serious start motor damage.

- 3 Move the gear selector lever to the “P” position and depress the brake pedal.

Warning

- Depress the brake pedal when the gear selector lever is at the “P” position. Never depress the accelerator pedal.

- 4 Press the engine start/stop button and check that the indicator on the button comes on in green (Engine start/stop button ON position).

- 5 Press the engine start/stop button to start the engine with the engine start/stop button ON position (indicator ON). The indicator on the button goes out when the engine is started.



Caution

- Do not press the engine start/stop button for a long time even though the engine fails to start.
- If you leave the engine start/stop button in the “ACC” or the “ON” position for a long time when the engine is not running, the battery may be discharged.



Warning

- The engine will start by pressing the engine start/stop button, only when the smart key is in the vehicle. Never allow children or any person who is unfamiliar with the vehicle to touch the engine start/stop button or related parts.
- If ESCL warning message appears on the display, immediately have the system checked by KG Mobility Authorized Service Center.
- Continuous driving with this message may cause serious damage to the steering system.

Notice

- To make the engine start easy, start the engine as follows in very cold weather.
 1. Press the engine start/stop button twice without depressing the brake pedal.
 2. The engine start/stop button becomes ON and the preglow indicator on the instrument cluster comes on.
 3. Wait until the indicator goes out, and depress the brake pedal and press the engine start/stop button.
- In the vehicle equipped with ESCL (Electrical Steering Column Lock) system, you may hear an operating sound from motor when starting and stopping the engine. This is normal operating condition.

Driving off

- 1 Make sure that there are no persons or obstacles in the dangerous area around the vehicle.
- 2 Release the parking brake.
- 3 * **Automatic transmission equipped vehicle**
Keep the brake pedal depressed and shift into the “D” or “R” position. Make sure that the position indicator of “D” or “R” comes on. Slowly release the brake pedal to begin moving.

* Manual transmission equipped vehicle

Keep the brake pedal and clutch pedal depressed and shift into the “1” or “R” position. Release the brake pedal and gradually depress the accelerator pedal while slowly releasing the clutch to begin moving.

Stopping the engine

- 1 Depress the brake pedal to stop the vehicle.
- 2 * **Automatic transmission equipped vehicle**
Move the gear selector lever to the “P” position.
* **Manual transmission equipped vehicle**
Move the gear shift lever to the Neutral position.
- 3 * **REKES system equipped vehicle**
Turn the ignition key to the “LOCK” position.
* **SMART Key equipped vehicle**
Press the engine start/stop button.
- 4 Apply the parking brake.
- 5 Remove the ignition key from the key cylinder (REKES).

Notice

- **Diesel engine learning mode:** The learning mode of the fuel injector is performed while the vehicle is driven or stationary to maintain the optimized engine condition. Weak noise and vibration of the engine may be accompanied by this mode. But, it is normal operation.



Caution

- Starting the vehicle in the winter months or operating the A/C in the summer months increases the engine rpm. Drivers must be careful when driving at this time because the vehicle can move faster than normal.
- Any modifications or alterations to this vehicle, including installation of an electronic device such as after-market remote starting system, could seriously affect its performance and safety and may lead to a serious injury or death.
- Using a mobile telephone or two-way radio requires careful considerations. The electronic control system of the vehicle is subject to possible errors due to electronic interference caused by improper use of these devices, and the electromagnetic waves can be harmful to the human body.
- When leaving the vehicle unattended, always turn off the engine to prevent unexpected rolling away.
- Always apply the parking brake with the brake pedal depressed when the vehicle is stopped.
- Do not store personal belongs and valuables inside the vehicle. When leaving the vehicle unattended, always make sure all the doors including the tailgate are closed and locked.

- Improper alignment of vibration dampers for the exhaust system (rubber hanger bracket) may result in serious vibration problems. When reinstalling the exhaust system after undercoating, check the alignment of the dampers.
- Always check the accelerator and brake pedals with your right foot before starting the vehicle. Even an experienced driver can accidentally hit the wrong pedal if he/she drives different vehicles.
- Power unit of the vehicle operates independently of the braking system of the vehicle, so just calmly depress the brake pedal to stop the vehicle when it moves unintentionally due to the driver error including pedal misapplication or a malfunction.



Caution

- If your vehicle becomes stuck in snow, mud or sand, depressing the accelerator pedal harder only makes the tires slip more which in turn causes damage to the transmission. If this happens, tow the vehicle away or take other actions as appropriate.
- Always contact the nearest KG Mobility Dealer or KG Mobility Authorized Service Center for adding and changing transmission fluid. A non-genuine fluid can cause various problems including malfunction and performance deterioration of the transmission, and those damages are not covered by the warranty.
- The application of tint film, especially metallic film, may interfere with radio signals. Low visible light transmission (VLT) of the film can lead to malfunction in the headlamp. Also, make sure that no liquid solution for application of tint film flows into the electronic components of the vehicle to prevent error or malfunction.
- The tinted glass with very low VLT and enhanced solar control characteristics reduces visibility through the glass significantly, especially at night or in the rain, thereby causing unforeseen safety problems.

- The interior materials of the new vehicle within a year or use can emit volatile organic compounds (VOCs). Therefore, always open all the windows for sufficient ventilation before entering. Those chemicals can cause headaches and dizziness especially in the cabin of the vehicle parked for a long time in direct sunlight. Therefore, to prevent the driver and passengers from being exposed to these harmful chemicals and keep the comfortable indoor environment, set the air source selection switch to the fresh air intake mode for as long as possible or open the windows periodically while driving.

Functions of ignition key

ACC Position

- The steering wheel is unlocked and electrical accessories are operative.
- The ignition key cannot be removed.

LOCK Position

- The ignition key can only be inserted or removed.
- The steering wheel can be locked.

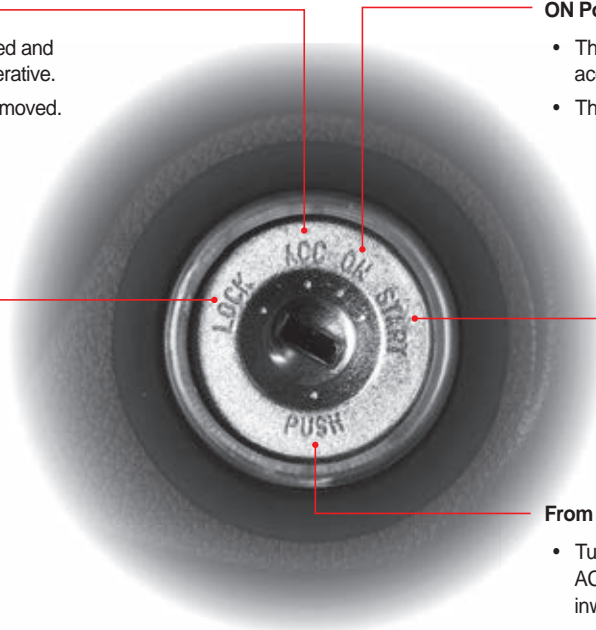

ON Position

- The engine runs and all electrical accessories can be used.
- The steering wheel is unlocked.

START Position

- Turn the ignition key to this position to start the engine. The engine will crank until you release the key; then it automatically returns to "ON" position.

From ACC to LOCK Position

- Turn the key to LOCK position from ACC position while pushing the key inward.

Unlocking the Steering Wheel

To unlock the steering wheel, insert the key and gently turn it to the ACC or ON position while slightly moving the steering wheel right and left.

Key Hole Illumination

The illumination lamp comes on when opening the door. This lamp goes out about 10 seconds after closing the door.

Key Reminder

The buzzer will sound if the driver's door is opened while the key is left in the ignition switch (ACC or LOCK position).

when starting the engine



Caution

- To unlock the steering wheel, insert the key and gently turn it to the “ACC” position while slightly moving the steering wheel right and left.
- The engine in a manual transmission equipped vehicle can only be started when the clutch pedal is fully depressed.
- Diesel engine equipped vehicle: Turn the ignition key to the “ON” position and wait until the glow indicator goes out. After then, turn the ignition key to the “START” position and hold it until the engine starts. But do not hold the ignition key at the “START” position for more than 10 seconds.
- The engine in an automatic transmission equipped vehicle can be started only when the gear selector lever is at the “P” or “N” position.
- Keep the brake pedal depressed when starting the engine.
- If the engine fails to start, turn the key back to the “LOCK” position and wait for 10 seconds. Then try again before any attempt to start the engine.
- After starting the engine, let it run for approx. 2 minutes at idle speed. Do not accelerate the engine during the warming up period.

- A warning buzzer sounds when opening the driver’s door with the key positioned at the “ACC” or “LOCK” position.
- Do not leave the key at the “ACC” or “ON” position when engine is not running. Otherwise, the battery could run down.
- Never depress the accelerator pedal while starting.



Caution

- Do not operate the starter for more than 10 seconds at a time. (The starter may be damaged.)
- To prevent any damage to the starter, put the ignition switch to the “LOCK” position and wait for at least 10 seconds before restarting the engine.
- Never turn the key to the “LOCK” position or remove the ignition key from the ignition switch while driving. The steering wheel will be locked and you may end up with serious injuries.
- Never use any duplicated key not provided from KG Mobility.
- The duplicated key might not turn back to the “ON” position. It may cause a fire due to an overload in the electric circuit. In addition, the engine with the immobilizer system cannot be started with the duplicated key.

- For a vehicle with automatic transmission, apply the parking brake with the gear selector lever in “P” position. Otherwise, the vehicle can roll away unexpectedly causing a serious accident.
- Do not operate ignition switch or other switches while driving. You will not be able to control the steering wheel or the vehicle and could be seriously or even fatally injured.
- Do not stack luggage or other cargo around the driver seat. Any such objects could interfere with your control of the vehicle and can cause harm.

Battery replacement for REKES key

When the operational distance noticeably decreases or the remote control does not work occasionally, replace the battery with a new one.

The internal circuit of remote control key is vulnerable to static electricity. If you are not familiar with replacing the battery, replace it at KG Mobility Dealer or KG Mobility Authorized Service Center.



Replacing Procedures:

- 1 Remove the cover at the back side of the REKES key using a smallest flat-bladed screwdriver while taking care not to damage it.
- 2 Remove the rear cover and replace the battery.



- 3 Use only specified battery (CR2032). Make sure that the battery is installed in correct direction.
- 4 Install the battery in the reverse order of removal.

Caution

- Use only the specified battery. Otherwise, the remote control key may not work properly.
- Make sure that the battery is installed in correct direction.
- Dispose the used battery in accordance with local regulations.
- Both REKES key and smart key are not completely waterproof. Repairing or replacing a damaged key due to water exposure (e.g. Drink, moisture, etc.) will not covered by your warranty.

START/STOP switch

OFF status

The power is turned off.



The indicator is turned off.

- The power is not supplied to the electric accessories of the vehicle.

Caution

- If the gear shift lever is not placed in the P (parking) position, the START/STOP switch cannot be in the OFF status (vehicle power OFF). Also, the vehicle doors cannot be locked and it is impossible to enter the theft monitoring mode.

Notice

- When the engine is turned on, make sure to place the gear shift lever in the P (parking) position and turn off the engine by pressing the START/STOP switch.

ACC status

Some electric accessories can be used.



Orange ACC indicator turns on.

- With the START/STOP switch in the OFF status, press the START/STOP switch once without depressing the brake pedal.
- The power is supplied to the vehicle and some electric accessories can be used.

Caution

- The START/STOP switch in the ACC status is not the status that the engine is turned on. Using an electric accessory in the vehicle for a long period of time in this status may deplete the battery.

ON status

Most electric accessories can be used.



Red ON indicator turns on.

- With the START/STOP switch in the OFF status, press the START/STOP switch twice without depressing the brake pedal.
- The power is supplied to the vehicle and most electric accessories can be used.

Caution

- The START/STOP switch in the ON status is not the status that the engine is turned on. Using an electric accessory in the vehicle for a long period of time in this status may deplete the battery.
- If the smart key system is abnormal, the indicator blinks 5 times with the START/STOP switch in the ON status. Have your vehicle checked and serviced at a KG Mobility authorized service center immediately.

READY status

Possible to start the engine



Green READY indicator turns on.

- This is the status that the gear shift lever is placed in the P (parking) or the N (neutral) position and the brake pedal is depressed for starting the engine.

Warning

- The engine can also be started after the gear shift lever is placed in the N (neutral) position. However, start the engine after placing it in the P (parking) position for safety.

Notice

- After you start the engine, the READY indicator turns off.

Starting the engine

When you place the gear shift lever in the P (parking) or the N (neutral) position and press the START/STOP switch while depressing the brake pedal, the engine is started.

Starting the engine

- 1 Get in the vehicle while carrying the smart key.
- 2 Be sure that all occupants fasten their seat belt.
- 3 Check for safety that the parking brake is applied.
- 4 Turn off all electric accessories.
- 5 Place the gear shift lever in the P (parking) or N (neutral) position.
- 6 Depress brake pedal.
- 7 Check if the READY status indicator on START/STOP switch is turned on.
- 8 If the READY status indicator is turned on, start the engine by pressing the START/STOP switch.

When the engine is started, the READY indicator turns off.



Warning

- **The engine can also be started also after the gear shift lever is placed in the N (neutral) position. However, start the engine after placing it in the P (parking) position for safety.**

Notice

- **A diesel-powered vehicle requires preheating before the engine is started if the engine is cold, and the vehicle should be driven after the engine is heated.**

Restarting the engine when it cannot be started

Wait for more than 10 seconds with the START/STOP switch in the OFF status and then press the START/STOP switch again to prevent the starting motor from being damaged.



Caution

- **Do not press and hold down the START/STOP switch or press it repeatedly because the engine cannot be started.**
- **The communication with the smart key system is not smooth on top of the seat where the heater function is activated or the floor of the vehicle and the area near the pedal, so the smart key recognition performance may be lowered.**
- **If the engine cannot be started by pressing the START/STOP switch, press the START/STOP switch directly using the smart key or have your vehicle checked and serviced at a KG Mobility authorized service center.**
- **Maintaining the START/STOP switch ACC or ON status and using the audio system with the engine turned off may deplete the battery.**

Starting the engine in winter

If you press the START/STOP switch with the brake pedal depressed when it is cold, the engine does not start immediately and the glow indicator (00) on the instrument cluster turns on.

At this time, if you depress the brake pedal until the glow indicator turns off, the engine starts after the glow indicator turns off.

In case of severe cold, start the engine in the following order for smooth engine starting.

- 1 Press the START/STOP switch twice without depressing the brake pedal.
When the START/STOP switch is in the ON status, the glow indicator on the instrument cluster turns on.
- 2 Wait for a number of seconds until the glow indicator turns off, start the engine with the brake pedal depressed.

Notice

- If the engine is already preheated, the glow indicator may not turn on.
- The preheating time may become longer as the temperature of engine coolant is lower. If the outside air temperature is high, as in the summer season, the engine can be started immediately without preheating.

Stopping the engine

The engine can be turned off only when the gear shift lever is placed in the P (parking) position and the brake pedal is depressed.

- 1 After stopping the vehicle completely, keep the brake pedal depressed.
- 2 Shift the gear shift lever to the P (Parking) position.
- 3 Apply the parking brake.
- 4 Turn off the engine by pressing the START/STOP switch, and then take your foot off the brake pedal.

Be sure to check that the engine is turned off and if there are any other abnormalities, and get out of the vehicle with the smart key.

What is diesel engine learning mode?

The learning mode of the diesel engine fuel injector is carried out while driving or stopping the vehicle in order to maintain the optimal engine condition.

At this time, slight noise and vibration may occur in the engine. This is not a failure of the vehicle.

What is the engine self-cleaning operating sound?

When the engine stops after driving, the system carries out the process to clean the valve where intake air and exhaust gas pass through automatically and perform position learning.

At this time, the operating sound may occur from the engine according to the engine condition and self-cleaning process. This is not a failure of the vehicle.

Stopping the engine while driving (in the event of emergency)

If you need to turn off the engine in an emergency situation such as an accident or vehicle damage while driving, press and hold down the START/STOP switch for 3 seconds or more, or press it three times within 1.5 seconds.

The engine is turned off and the START/STOP switch is set to the ACC status.



Warning

- Never turn off the engine while driving unless there is an emergency situation such as an accident or vehicle damage. Doing so may make the steering wheel heavier and lower the brake performance, becoming very dangerous.

Notice

- If the vehicle is driving continuously with the engine turned off, you can start the engine again by placing the gear shift lever in the N (neutral) position and pressing START/STOP switch without depressing the brake pedal.

System safety mode

If a critical system defect occurs or the main electric and fuel systems of the engine are abnormal, the system enters the safety mode in order to protect the vehicle system.

When the vehicle enters the system safety mode, the engine warning light may turn on and the driving performance may decrease or the engine may be turned off.



Caution

- When the vehicle enters the system safety mode, stop the vehicle at a safe place immediately, turn off the engine, tow your vehicle to a KG Mobility authorized service center through the emergency roadside service and have the relevant system checked and serviced.
- If you drive the vehicle in the system safety mode, the engine RPM is fixed, disabling normal driving and the engine may be turned off. Driving the vehicle continuously may damage the system significantly.

Cautions for using the START/STOP switch



Warning

- The smart key system allows you to start the engine by pressing the START/STOP switch with the brake pedal depressed within its operation range. Caution should be taken that a person who is unfamiliar with the system such as the engine check and in any other situations, especially a child, may start the engine.
- Never press the START/STOP switch while driving. Doing so may result in a dangerous situation due to the suspension of power supply.



Caution

- Be sure to start the engine with the brake pedal depressed.
- Do not depress the accelerator pedal when starting the engine.
- If the engine cannot be started, wait for 10 seconds or more to prevent the starting motor from being damaged and restart the engine.
- After starting the engine, idle the engine for 1 to 2 minutes and then drive off in the vehicle. In particular, drive the vehicle slowly for approximately 300 m after driving off for smooth rotation of the engine and other driving systems during winter.
- If you open the door and leave the vehicle with the smart key with the START/STOP switch in the ON status or while the engine is running, a warning message is displayed on the instrument cluster with a warning buzzer.
- Pay particular attention not to start the engine when checking the vehicle from the outside, especially the engine room.
- Do not use a non genuine smart key or a replicated key.
- The communication with the smart key system is not smooth on top of the seat where the heater function is activated or the floor of the vehicle and the area near the pedal, so the smart key recognition performance may be lowered.

- The vehicle is controlled by various electronic control units. If you attach and use a device that creates radio waves or electromagnetic waves near the smart key or the vehicle, various vehicle control systems may malfunction.
- When you operate the START/STOP switch while a smartphone is placed near the smart key or charging the smartphone battery through the power socket in the vehicle, the engine may not start occasionally.

Remote control key and ignition key



A Panic Button

Panic Function (press and hold)

If you press and hold this button for approx. 1 seconds the hazard warning flashers blink and the siren sounds for approx. 30 seconds.

The panic function will stop when only panic button on the remote control key is pressed.

PANIC BUTTON (EU)

(Operative only when the ignition key is inserted)

B Door Lock Button

Lock (briefly press)

If you press this button briefly, all doors and the tailgate are locked and the theft deterrent mode is activated.

When the theft deterrent mode is activated, the hazard warning flashers blink twice. However, if you press this button again in 4 seconds, the hazard warning flashers blink twice and the buzzer sounds once.



Caution

- To arm the theft deterrent mode, the ignition key should be removed from the ignition switch, all doors including the tailgate and the engine hood should be closed completely. If you press this button when either tailgate or engine hood is open, the doors will be locked but the theft deterrent mode will not be activated. In this case, when you close the opened tailgate or engine hood, the theft deterrent mode will be automatically activated with blinking the hazard warning flashers twice.
- To prevent REKES key damages, do not expose the key to high temperature or do not get the key wet.
- When the doors are locked using the REKES key, make sure to check if they are securely locked including tailgate, in order to prevent from theft.
- With one REKES key left in the ignition key hole, doors cannot be locked using another REKES key.

Notice

- For the setting procedures of automatic folding of outside rearview mirrors, refer to Chapter 4.
- Locking the doors from the driver's door using the ignition key will work the same.

C Door Unlock Button

Unlock (briefly press)

- If you press this button briefly, all doors and the tailgate are unlocked and the theft deterrent mode is deactivated.
- The outside rearview mirrors are unfolded when the automatic folding is selected.
- When the deterrent mode is deactivated, hazard warning flashers blink once.
- If a door, tailgate or the engine hood is not open within 30 seconds after unlocking doors using REKES key (ignition key) in theft deterrent mode, all doors will be automatically locked and the hazard warning flasher will blink twice with one warning buzzer sound. (change to theft deterrent mode)

Notice

- For the setting procedures of automatic folding of outside rearview mirrors, refer to Chapter 4.

Short Press of UNLOCK Button

- The doors including the tailgate are unlocked and the theft deterrent system is disarmed.
- The outside rearview mirror is unfolded automatically (outside rearview mirror folding/unfolding switch not pressed).
- The hazard warning lamp flashes once and buzzer sounds twice signifying that the theft deterrent is disarmed.

Notice

- Refer to “**Outside rearview mirror control switch**” in Chapter 4 for details about setting the outside rearview mirror AUTO folding/unfolding control.



To use the mechanical key:

Press the button. The mechanical key is automatically folded up.

To stow the mechanical key:

Press the button and push it into its slot.

Caution

- The key can be broken when folding not to press button.



Caution

- Under the following conditions, the remote control key does not operate.
 - When the key is in the ignition switch
 - When you are too far from your vehicle (over 10 m)
 - When the battery in remote control key is discharged
 - When your vehicle is behind other vehicles or obstacles
 - In very cold weather
- The remote control key could be damaged easily by moisture and heat. Be sure to keep away from them.
- Operating range could be changed depending on the surrounding conditions. It is recommended to use the remote control key in 10 m from your vehicle.
- Under the following conditions, the remote control key may not work due to another radio wave. In these cases, open the doors using key and key hole in door.
 - In the place near police office, government office, broadcasting station, military base, transmitting tower, airport, and port
 - When you have the radio or mobile phone with the remote control key
 - When another remote control key is using near your vehicle



Caution

- If your remote control key is not working properly, have the system checked by KG Mobility Dealer or KG Mobility Authorized Service Center.
- Opening the tailgate will not trigger the theft deterrent alarm even in theft deterrent mode.

When a Remote Control Key is Lost

When one of remote control keys is lost and a new remote control key is purchased, bring the other old key to the nearest KG Mobility Dealer or KG Mobility Authorized Service Center and have it recoded. Otherwise, the old key will not work.

To prevent from being stolen by the lost key, immediately take a recoding for new key when you lost a key.



Caution

- If you lose your key, you have to replace the whole key set to prevent from theft.

Room Lamp ON

If the room lamp switch in overhead console is in DOOR position, the front and center room lamps come on for 30 seconds when you press the unlock button on the remote control key. The lamps immediately go off when the remote lock button is pressed.

Puddle Lamp Function

The puddle lamps at bottom of outside rear view mirror housings are illuminated for 30 seconds when you unlock the door with the smart key or when you open the driver's door after the engine start/stop button to OFF from ON position. The lamps immediately go off when pressing the door lock button or starting the engine.

The puddle lamp is turned on when you are approaching the vicinity of the vehicle with smart key.

Smart key*

Smart key is a device which is designed to lock/unlock the doors and start the engine by just carrying it.

Also, the common functions of the remote control key are available by using the buttons on the smart key.



A Short Press of LOCK Button (Locking Doors)

- All doors and the tailgate are locked and the theft deterrent system is armed.
- The outside rearview mirror is folded automatically. (outside rearview mirror folding/unfolding switch is not pressed)
- The hazard warning lamp flashes twice and buzzer sounds once as soon as the theft deterrent is armed.

Notice

- Refer to “Outside rearview mirror control switch” in Chapter 4 for details about setting the outside rearview mirror AUTO folding/unfolding control.

! Caution

- All doors including the engine hood should be closed to arm the theft deterrent system. Locking the doors using the smart key with the engine hood open only locks the doors and does not arm the theft deterrent system. If you close the engine hood after locking the doors with a smart key, the hazard warning lamp flashes twice and buzzer sounds once signifying that the theft deterrent system is armed.
- Locking the door with door LOCK button on the smart key is not possible when the ignition switch is in ACC/ON position or the engine is running.
- Whether the cargo deck's tailgate is open or closed has no effect on entering the theft deterrent mode.

B Short Press of UNLOCK Button

- The doors including the tailgate are unlocked and the theft deterrent system is disarmed.
- The outside rearview mirror is unfolded automatically (outside rearview mirror folding/unfolding switch not pressed).
- The hazard warning lamp flashes once and buzzer sounds twice signifying that the theft deterrent is disarmed.

Notice

- Refer to “Outside rearview mirror control switch” in Chapter 4 for details about setting the outside rearview mirror AUTO folding/unfolding control.

C Panic Button (Type B)

- Pressing and holding the button makes the hazard warning lamps flash and buzzer sound for 30 sec.
- To deactivate the theft deterrent alarm, press and hold the panic button again.

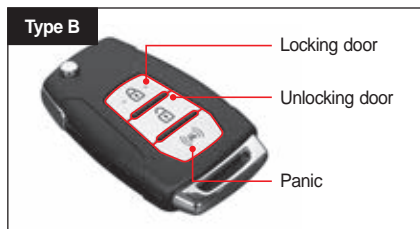

Button name		Short press	Long press
Locking door		Locking door	-
Unlocking door		Unlocking door (When safety UNLOCK is enabled, only driver door is unlocked)	-
Type B	Panic	-	Panic (ON/OFF)

! Caution

- To prevent the smart key from being damaged, avoid places with a high temperature and high humidity.
- Always check that locked status of the doors and tailgate after locking the doors with the smart key. If the doors are not locked, the vehicle itself or your personal belongings in the vehicle can be stolen.
- If a key is lost, you cannot open the doors of the vehicle or start the engine. If you don't have a spare key, take the vehicle to a KG Mobility Authorized Service Center by towing it and have the vehicle serviced. Also, take the appropriate action to prevent your car and belongings from being stolen.
- Always check if the ignition switch is in OFF position and you are carrying a registered smart key after exiting your vehicle.
- Carry only one smart key.
- If the smart key which was last used is inside the vehicle and the vehicle is locked with another registered key, the door is locked properly but you cannot use the key inside the vehicle until the next start up. This is a safeguard against theft.

Additional functions of smart key*

Smart Door AUTO Lock (AUTO Close)

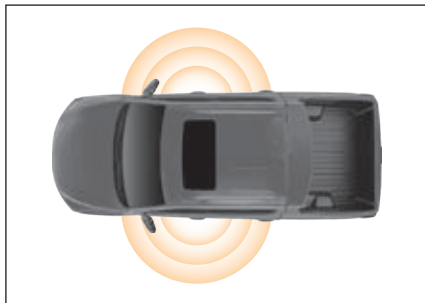

If you move a certain distance away from the vehicle while carrying a smart key with all doors including tailgate closed, all doors including tailgate will be locked and the theft deterrent system will be armed.

If you stay in the key detection area for 1 min. or more under the same conditions, the AUTO lock function is activated for theft protection.

The hazard warning lamp flashes twice and buzzer sounds once as soon as the theft deterrent is armed.

Notice

- Refer to “Outside rearview mirror control switch” in Chapter 4 for details about setting the outside rearview mirror AUTO folding/unfolding control.

Activating the smart door auto lock function (Activating from the instrument cluster)

• Supervision type

Tick the box at **Vehicle setting** → **Door / Tailgate** → **Smart door auto lock** under  (user settings) in the instrument cluster.

• Standard type

Tick the box at **Door / Tailgate** → **Smart door auto lock** under  (user settings) in the instrument cluster.

Activating the smart door auto lock function (Activating with the smart key)

- 1 With the START/STOP switch in the ON status, press the hazard warning lamp switch.
The hazard warning lamp turns on.
- 2 Press the Door lock button on the smart key three times consecutively within 2 seconds.

Warning

- If the smart key is in the deck or luggage compartment with the smart door AUTO LOCK enabled, the tailgate may not be opened by the activation of the smart door AUTO LOCK. Do not place the smart key in the deck (luggage compartment) with the smart door AUTO LOCK enabled.

Caution

- The detection of smart key can vary depending on the walking speed and surrounding environment.
- When using the smart door AUTO lock function, always check the locked state of the doors and tailgate after seeing the flash of hazard warning lamp (twice) and hearing a buzzer sound (once).
- If there is any smart key left inside the vehicle, the smart door AUTO lock function will not be activated.
- When the smart key battery is fully depleted, the smart door AUTO lock function will be disabled automatically. Therefore, you should reset the vehicle setting in the instrument cluster after replacing the smart key battery.



Caution

- If the driver carrying a smart key moves to the tailgate with the smart door AUTO LOCK enabled, the smart door AUTO LOCK function can be activated.
- If the system cannot detect a valid smart key because of other circumstances including interference with surrounding wave field or low battery voltage, the AUTO door LOCK may not be activated.
Always check the locked state of the door before leaving the vehicle.

Locking/unlocking the door with the door handle switch (Type A)

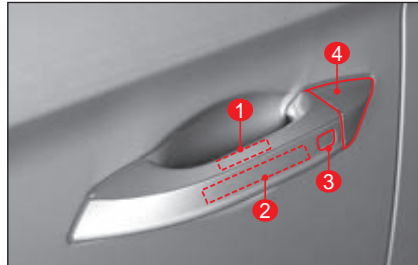

- 1 Door handle touch sensor (unlock)
- 2 Outside antenna
- 3 Door handle touch sensor (lock)
- 4 Emergency key hole cover

Locking the door with the touch sensor

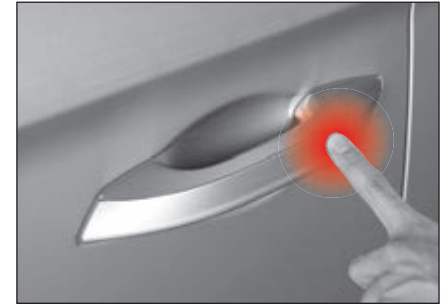

- 1 Stay in the outside antenna area of the vehicle (approximately 1.5 m) while carrying the smart key.
- 2 With all doors and the tailgate closed, touch the driver seat door handle touch sensor (lock) (1) slightly.
 - After touching, the authentication of a valid smart key (detection of a valid smart key) within the outside antenna area of the vehicle is carried out for approximately 1 second.
 - When the authentication of smart key is complete, all doors and the tailgate are locked.
 - When the theft monitoring mode is activated, the hazard warning lamp blinks twice and the warning buzzer sounds once.

Notice

- It takes time to authenticate the smart key. If you operate it too fast, the relevant system may not operate.
- The unlock touch sensor does not operate for approximately 3 seconds after locking the door using the touch sensor.
- In any of the following cases, the door cannot be locked even if you touch the touch sensor.
 - When you attempt to lock the door with the smart key in the vehicle
 - When the START/STOP switch is in the ACC or the ON status or the engine is running
 - When any door is opened

Unlocking the door with the touch sensor



- 1 Stay in the outside antenna area of the vehicle (approximately 1.5 m) while carrying the smart key.
- 2 Touch the driver seat door handle touch sensor (unlock), (2) just touching it gently.
 - After touching, the authentication of a valid smart key (detection of a valid smart key) within the outside antenna area of the vehicle is carried out for approximately 1 second.
 - When the authentication of the smart key is complete, only the driver seat door is unlocked.
 - When the theft monitoring mode is canceled, the hazard warning lamp blinks once and the warning buzzer sounds twice.
- 3 Open the driver seat door by pulling the door handle slowly.

Notice

- It takes time to authenticate the smart key. If you pull the door handle fast, the relevant system may not operate.
- The lock touch sensor does not operate for approximately 1 second after unlocking the door using the touch sensor.
- If you carry a valid smart key, operating the touch sensor on the door handle except for the driver seat door handle unlocks all doors even if the safety unlock function is enabled.

Cautions for using the smart key system (touch sensor)



Warning

- Do not leave the vehicle with the smart key in the vehicle when a person (especially a child) who does not know the vehicle system is present in the vehicle. Pressing the START/STOP switch with the brake pedal depressed while the smart key is in the vehicle starts the engine. Other incorrect vehicle controls may occur. In such case, a serious accident may occur. Therefore, always pay attention.



Caution

If the smart key does not operate or is not recognized

- When you lock the door using a smart key from the outside of the vehicle or the touch sensor on the door handle while another smart key is present inside the vehicle, the smart key function (including the remote control function) activated by simply carrying the smart key is lost temporarily (the warning buzzer sounds). To restore the original function, deactivate the theft monitoring mode of the vehicle using the smart key from the outside of the vehicle or the touch sensor on the door handle.

- If the vehicle is in a place where strong radio waves are transmitted or received, if the vehicle is equipped with a two-way radio or other transmission and reception systems or if a smart key is used in another nearby vehicle, the smart key system may not function normally.
- The smart key recognition performance may be lowered on a blind spot above the seats where the heater function is activated or the floor of the vehicle and the area near the pedal, so the smart key system may not function. In such case, carry the smart key or place the smart key in a different location.
- If the engine cannot be started while the smart key is placed inside the vehicle or you are carrying it, start the engine by pressing the START/STOP switch with the smart key directly.

Using the smart key

- Carry only one smart key.
- Store each smart key separately. When you lock the door using the LOCK touch sensor on the door handle instead of the Door lock button on the smart key, be careful not to leave the smart key inside the vehicle.
- If you leave the vehicle even for a moment, turn off the engine and carry the smart key with you and do not store a spare smart key inside the vehicle. Failure to do so may cause vehicle theft or malfunction.

- Using 2 smart keys provided by KG Mobility Corporation on one key chain at the same time may cause the smart key system to malfunction or engine starting failure.

Managing the smart key

- When you lock the door with another smart key with the previously used smart key in the vehicle, the door can be locked normally but you cannot start the engine with the key left in the vehicle until it is used normally next time. This is a safety system for preventing theft.
- Do not allow water or liquid to flow into the smart key. Caution should be taken as the smart key is not fully waterproof, so if moisture or water gets in, it may cause a malfunction that is not covered by the warranty.
- The electronic systems in the smart key are vulnerable to moisture or heat, so placing the smart key in a place with high humidity or high temperature may cause a failure.
- If the smart key is lost, you cannot open the door or start the engine. If you don't have a spare smart key in storage, you need to have your vehicle towed and serviced at a KG Mobility authorized service center. Also, the vehicle or an article in the vehicle may be lost due to the lost smart key, so take measures immediately.

Using and managing the door handle touch sensor

- A different person in the operating range of the smart key may unlock the door using the touch sensor. Be careful of theft of an article in the vehicle.
- Do not operate the door lock/unlock touch sensors at the same time. Doing so may cause a system error and the sensors may not operate.
- After locking or unlocking the door, the touch sensor does not operate for a certain period of time. Operate it a certain period of time later.
- The touch sensor may not operate if you are wearing thick gloves. Take off the gloves and operate the touch sensor.
- The touch sensor may be detected by a car wash (high pressure spraying car wash, etc), heavy rain or a strong stream of water.
- If a foreign material (water, dust, etc.) is present on the surface inside the door handle, it may affect the detection carried out by the touch sensor so that the touch sensor may not operate normally.
- If the touch sensor is not operating, wipe the surface of the touch sensor using a clean cloth. If the touch sensor is not operating after wiping its surface, visit a nearby KG Mobility authorized service center and have your vehicle checked and serviced.

Locking/unlocking the door with the door handle switch (Type B)

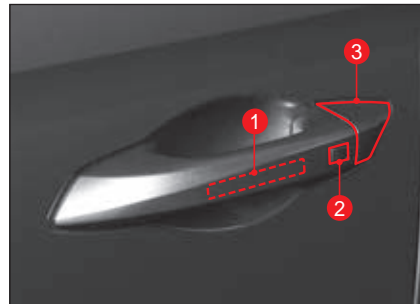

- 1 Outside antenna
- 2 Door lock/unlock button
- 3 Mechanical key hole

To lock with door handle switch

- 1 Stay in the outside antenna area of the vehicle (approximately 1 m) while carrying the smart key.
 - 2 Press the door lock / unlock button (2) with all the doors and tailgate closed.
 - 3 All the doors and tailgate are closed.
 - When the theft monitoring mode is activated, the hazard warning lamp blinks twice and the warning buzzer sounds once.
 - If the Outside rearview mirror folding/unfolding button is in the neutral position, the outside rearview mirror is folded.
- ☞ Refer to "Folding/unfolding the outside rearview mirror" (p.3-48)

Notice

- It is not possible to lock the door with the door lock / unlock button when the ignition switch is in ACC or ON position or the engine is started.

Notice

Pressing the LOCK/UNLOCK button does not lock the doors in the following cases:

- When trying to lock the door with the smart key in the cabin
- Ignition switch in ACC/ON or engine running
- Any door is open



Caution

- Always check if the ignition switch is in OFF position and you are carrying a registered smart key after exiting your vehicle.
- Carry only one smart key.
- If the smart key which was last used is inside the vehicle and the vehicle is locked with another registered key, the door is locked properly but you cannot use the key inside the vehicle until the next start up. This is a safeguard against theft.

Door Outside Handle Switch Unlock (Safety UNLOCK disabled)

- 1 Stay in a vehicle outside antenna area (within approx. 1 m) while carrying a smart key.
- 2 Press on the door LOCK/UNLOCK button on the front/rear door outside handle.
- 3 The hazard warning lamp flashes once and buzzer sounds twice signifying that all doors including the tailgate are unlocked. Pull the lever to open the door.



Caution

- If the doors are unlocked by using this function, anyone within the smart key actuation area can open the doors. Be aware of the theft.

Cautions for using smart key



Caution

- If you lock the doors by pressing the door LOCK button on the door outside handle or smart key from outside the vehicle with another smart key inside the cabin, the smart key functions available just by carrying it including the remote control function will be disabled temporarily (buzzer sounds). To restore the functions, disarm the theft deterrent system by pressing the button on the door outside handle or smart key.
- If the engine is not started with a smart key inside the cabin or being carried, start the engine by putting the smart key against the ignition switch and pushing to operate the switch.
- The smart key may not function if the vehicle is in an area which has strong electric waves or noise, the vehicle is equipped with a third party two-way radio/transmit-receive device, or a smart key for nearby vehicle is used.
- If a smart key is located near the accelerator/brake pedal, on the vehicle floor or seat cushion equipped with heated wire, the key may not be detected. If this is the case, carry the smart key in your pocket or put the key in a different location in the cabin.



Caution

- Additional smart keys on the same key chain may cause key related fault and engine starting failure.
- Therefore, the smart keys should be stored separately, and no smart keys should be in the cabin when the vehicle doors are locked by LOCK button on the door outside handle.
- If a smart key is in the cabin, you can start the engine by pressing the ignition switch with the brake pedal depressed. Do not leave other persons who don't know about the system, especially children, with a smart key inside the parked vehicles. The engine may be started accidentally or the vehicle can be controlled incorrectly. This could result in a serious accident.
- When you leave the vehicle even for a very short time, always turn the ignition off, carry the smart key in your pocket, and do not leave the spare key inside the vehicle. Otherwise, the vehicle including valuables can be stolen or malfunctions may occur.
- Make sure that water or liquid does not enter the smart key. Failure to do so can lead to smart key failure and this failure will not be covered by warranty.
- If a key is lost, you cannot start the engine. Contact the nearest KG Mobility Dealer.

Using emergency key (smart key)*

How to Remove Emergency Key



- Pull out the emergency key by pressing the button for emergency key.
- To fold in the emergency key, press and hold the button.



Caution

- Attempting to fold in the key without pressing the button can damage the emergency key.

Door LOCK/UNLOCK With Emergency Key

Follow the procedures to lock/unlock the doors by removing the driver door handle cover in case of emergency.

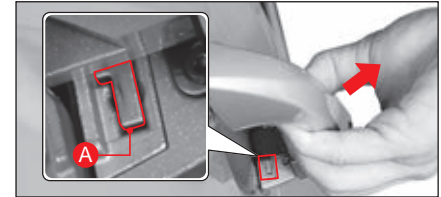

- 1 Pull out the driver door handle cover in the direction of the arrow to access the emergency key cover release hole lever (A).



- 2 Insert the emergency key or flat bladed screwdriver (A) into the emergency key cover release hole lever and press in the lever (A).



Caution

- Be careful not to scratch the door panel or lose the removed handle cover.



- 3 While pressing in the lever (A), push down the top side of the cover to remove it.

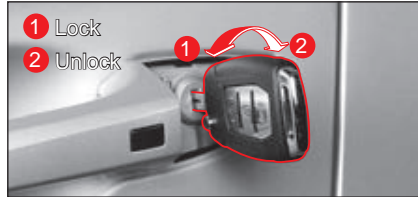

- 4 Insert the emergency key into the key hole and turn it counterclockwise/clockwise to lock/unlock the door.

Notice

- **If outside rearview mirror folding/unfolding switch is not pressed, the theft deterrent system will be disarmed and the side mirrors will be unfolded.**

Smart key battery low

Starting Engine With Smart Key Battery Dead

Opening/closing doors: If you cannot lock/unlock the doors using a smart key because of dead battery or wave interference, use the emergency key to lock/unlock the doors as shown below.

Engine Start: If you cannot start the engine even with a smart key in the vehicle because of dead battery or wave interference, you can start the engine by using the smart key as shown below.

Make sure to replace the battery or check the smart key after locking or unlocking the doors by using these methods.



Insert the emergency key into the key hole and turn it clockwise to unlock the door.

Notice

- If the vehicle theft deterrent system is armed, warning buzzer will sound.



Put the one end of the smart key against the ignition switch and push it while depressing and holding the brake pedal with the gear selector lever in P or N position and. The warning buzzer will stop if it was activated.

Notice

- If the door is opened after the engine starting when the smart key battery is low, a warning message “No smart key inside vehicle” will be displayed. The message will go off if you turn off the ignition and then restart the engine.

Replacing smart key battery

If the operation range of your smart key is dramatically decreased or the smart key does not operate intermittently, replace the battery of the smart key. The internal circuit of the smart key may be broken by the static electricity. Therefore, if you have any doubt about your ability to replace the battery, visit KG Mobility service center for servicing.



! Caution

- Use only the specified battery. The smart key may not work properly because of improper contact when using a battery with non-original dimensions.
- Do not mistake the polarity.
- Used batteries should be disposed of in compliance with local regulations.
- The smart key is not water-proof. A damaged key due to water exposure (e.g. beverages, moisture, etc.) will not covered by your warranty.



- 1 Remove the cover at the back side of the smart key using a smallest flat-bladed screwdriver, taking care not to scratch the cover.



Specification **One battery (CR2032)**

- 2 Remove the rear cover and replace the battery.
- 3 Install a battery (one battery - CR2032) that meets the specifications with the correct polarity.
- 4 Assemble in the reverse of removal.

Instrument cluster

Standard type

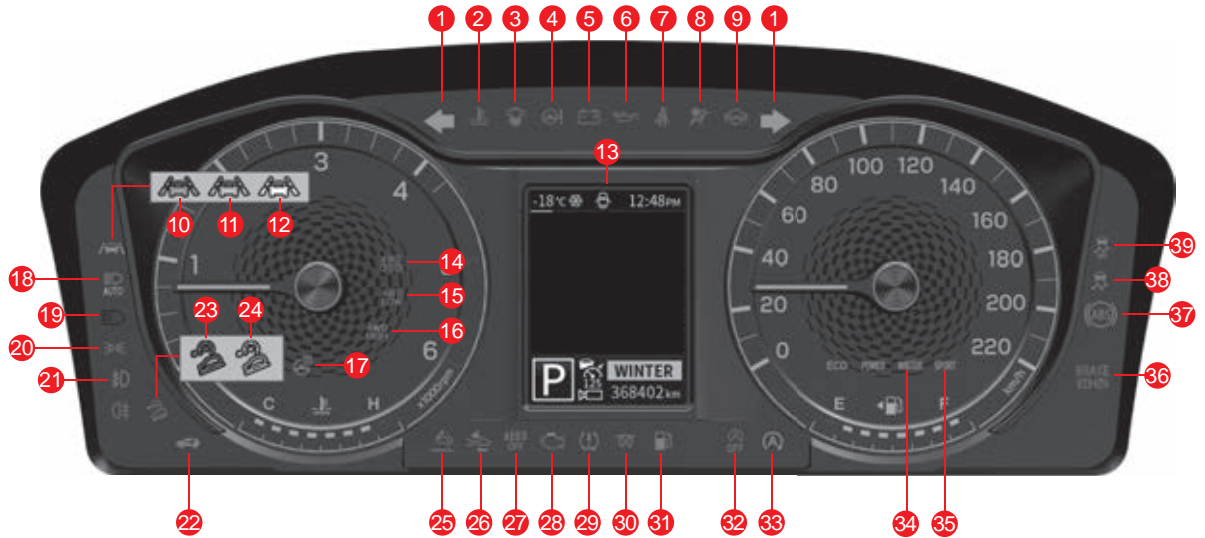

- 1 Turn signal / hazard warning flasher
- 2 Engine overheat warning lamp
- 3 Water separator warning light
- 4 Electric power steering (EPS) warning light (SSPS warning lamp)
- 5 Charge warning light
- 6 Engine oil pressure warning light
- 7 Seat belt reminder warning lamp
- 8 Air bag warning light
- 9 Hands OFF warning lamp
- 10 LKA (LDW) ON indicator (green)
- 11 LKA (LDW) warning lamp (yellow)
- 12 LKA (LDW) READY warning lamp (white)
- 13 Door ajar warning lamp
- 14 4WD CHECK warning light
- 15 4WD LOW indicator light
- 16 4WD HIGH indicator light
- 17 Steering wheel heating ON indicator
- 18 SHB (Smart High Beam) indicator
- 19 High beam indicator
- 20 Illumination ON indicator
- 21 Front fog lamp ON indicator
- 22 Immobilizer/Smart key warning light
- 23 HDC warning lamp (red)
- 24 HDC ON indicator (green)
- 25 Urea system (SCR) warning lamp
- 26 AEBS warning lamp
- 27 AEBS OFF indicator
- 28 Engine CHECK warning lamp
- 29 Global warning light
- 30 Warming up indicator
- 31 Low fuel level warning light
- 32 ISG OFF indicator
- 33 ISG indicator/warning light
- 34 WINTER mode indicator
- 35 SPORT mode indicator
- 36 Brake warning lamp
- 37 ABS (Anti-Lock brake system) warning lamp
- 38 ESP system ON indicator/warning lamp
- 39 ESP system OFF indicator

Supervision type*

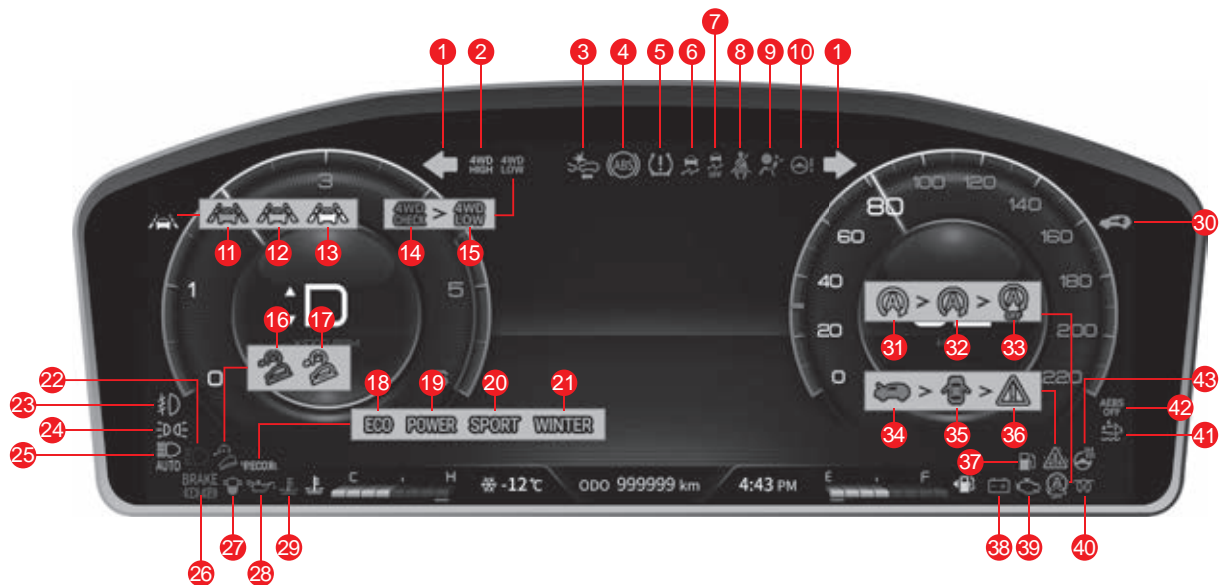

- 1 Turn signal / hazard warning flasher
- 2 4WD HIGH indicator light
- 3 AEBS warning lamp
- 4 ABS (Anti-Lock brake system) warning lamp
- 5 Global warning light
- 6 ESP system ON indicator/warning lamp
- 7 ESP system OFF indicator
- 8 Seat belt reminder warning lamp
- 9 Air bag warning light
- 10 Electric power steering (EPS) warning light
- 11 LKA (LDW) ON indicator (green)
- 12 LKA (LDW) warning lamp (yellow)
- 13 LKA (LDW) READY warning lamp (white)
- 14 4WD CHECK warning light
- 15 4WD LOW indicator light
- 16 HDC warning lamp (red)
- 17 HDC ON indicator (green)
- 18 ECO mode indicator
- 19 Power mode indicator
- 20 SPORT mode indicator
- 21 WINTER mode indicator
- 22 High beam indicator
- 23 Front fog lamp ON indicator
- 24 Illumination ON indicator
- 25 SHB (Smart High Beam) indicator
- 26 Brake warning lamp
- 27 Water separator warning light
- 28 Engine oil pressure warning light
- 29 Engine overheat warning lamp
- 30 ISG warning lamp (yellow)
- 31 ISG indicator (green)
- 32 ISG OFF indicator
- 33 Hood open warning lamp
- 34 Door ajar warning lamp
- 35 Master symbol
- 36 Low fuel level warning light
- 37 Charge warning light
- 38 Engine CHECK warning lamp
- 39 Warming up indicator
- 40 Steering wheel heating ON indicator
- 41 Urea system (SCR) warning lamp
- 42 AEBS OFF indicator
- 43 Steering wheel heater indicator

Driving information display window

Engine RPM

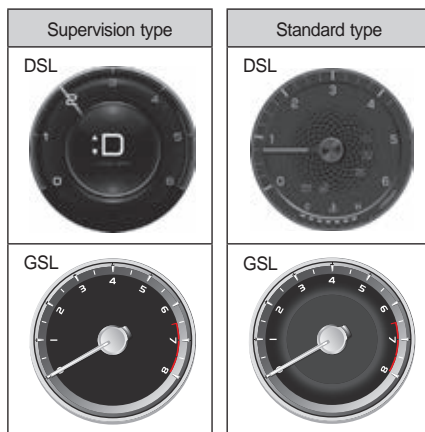

It indicates the revolutions of the engine per minute. Multiplying the number pointed to by the needle by 1,000 is the current engine RPM.

Caution

- Do not allow the needle to enter the red zone as the engine may be damaged significantly.

Driving speed

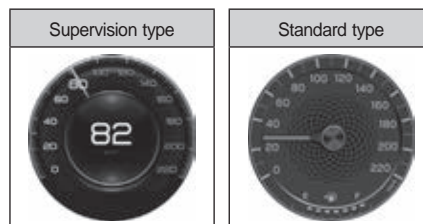

It indicates the current driving speed of the vehicle.

120
km/h

Over speed warning light (GCC only)

Sounds warning chime 5 times initially

Notice

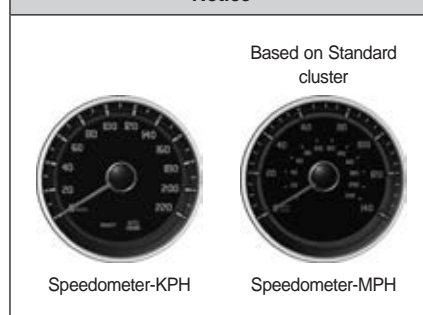

Engine coolant temperature

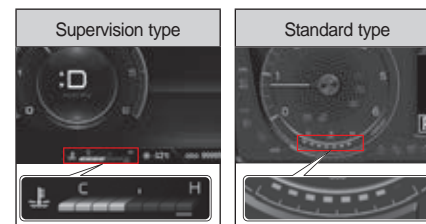

It indicates the temperature of the engine coolant.

Caution

- If the engine coolant gauge indicates near the engine overheating range (H) or the engine overheat warning lamp turns on, stop the vehicle at a safe place immediately and cool down the engine. Driving the vehicle continuously with an overheated engine may damage the engine significantly.

Fuel gauge

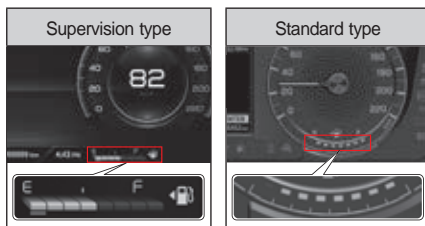

It displays the remaining fuel level when the START/STOP switch is in the ON status or the engine is running.

Refuel before the pointer of the fuel gauge reaches "E". If the low fuel level warning light turns on, refuel immediately.

The left arrow in the gas pump icon (◀🛢️) indicates that the fuel inlet is located on the left side of the vehicle.

Warning

- **Be sure to stop the engine when refueling.**

Caution

- **If the vehicle is on a hillside road, the remaining fuel level may not be displayed accurately.**
- **Use only the designated fuel and approved additives. Failure to do so may cause contamination of the fuel tank or clogging of the fuel filter, damaging the engine.**
- **Drive the vehicle with a proper fuel level. Failure to do so may damage the catalytic converter due to the non-combustion or incomplete combustion of fuel.**

Total mileage

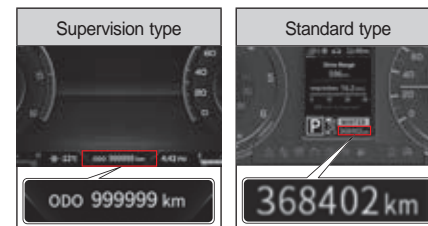

The total mileage of the vehicle is displayed in kilometers. The maximum mileage to be displayed is 999999 km.

Notice

- **It is normal if the total mileage at the time of shipping is less than 50 km.**

Position of gear shift lever

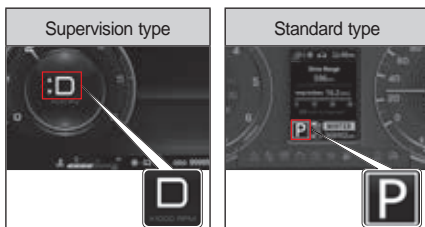

It displays the current position (P, R, N, D) of the gear shift lever and the gear stage (1~6stages) in the M (manual) mode.

Notice

- When entering the M (manual) mode, the gear is downshifted by one gear position from the current gear position.

Automatic Transmission

This indicator shows the current position of the gear.

In normal mode: P, R, N, D

Gear indication in "M" mode: 1, 2, 3, 4, 5, 6

P : Parking	1 : 1st gear
R : Reverse	2 : 2nd gear
N : Neutral	3 : 3rd gear
D : Driving (6A/T)	4 : 4th gear
(1~6th gear shifting)	5 : 5th gear
	6 : 6th gear

Gear shift point indicator

Gear shift point indicator is a supplementary function indicating the optimal shift point for fuel efficiency. To operate this function, manual gear shift control is necessary according to road and driving conditions.



- **Manual transmission:** indicates 3rd gear (target) shift point which is the optimum shift range, while driving in 1st or 2nd gear position
- **6A/T Automatic transmission (M mode):** indicates 4th gear (target) shift point which is the optimum shift range, while driving in 3rd gear position

Notice

- While driving in 1st ~ 6th gear position without shifting gear in automatic transmission (M mode) vehicle, the transmission may automatically shifts up to protect the system if the engine RPM gets high



- **Manual transmission:** indicates 3rd gear (target) shift point which is the optimum shift range, while driving in 4th or higher gear position

Notice

- While driving in 2nd ~ 6th gear position in automatic transmission (M mode) vehicle, the indicator ▼ (arrow) does not appear on display when downshifting. Drive shifting manually according to driving conditions. If driving without manual shift, RPM will get low and the system will shift down.

Manual transmission display



Automatic transmission display



Notice

- For vehicles with manual transmission, the indicator shows up only when the gear shifts or the shift lever is in R position.

Warning lights and indicators

Seat belt warning lamp



If the driver seat and front passenger seat occupants do not fasten the seat belt, the seat belt warning light blinks along with a warning buzzer.

If you fasten the seat belt at this time, the warning buzzer stops and the seat belt warning light stays on for the remaining time.

☞ Refer to "Seat belt warning" (p.2-2)

Air bag warning lamp*



The air bag warning lamp turns on when the START/STOP switch is in the ON status, and it turns off when there is no abnormality in the air bag system.

If the warning light stays on after starting the engine, the air bag system is abnormal. Have your vehicle checked and serviced at a KG Mobility authorized service center immediately.

☞ Refer to "Air bag*" (p.2-18)

Engine oil pressure warning light



The engine oil pressure warning light turns on when the START/STOP switch is in the ON status and it turns off when the engine is started.

This warning light turns on when the engine oil is insufficient or the engine lubrication system is abnormal.

When this warning light turns on while driving, park your vehicle at a safe place, check the engine oil level and add engine oil immediately if it is insufficient.

☞ Refer to "Replenishment" (p.6-19)

Caution

- If the warning light stays on after the engine oil is added, stop driving the vehicle immediately and have your vehicle checked and serviced at a KG Mobility authorized service center.
- Driving the vehicle continuously with the engine oil pressure warning light turned on may damage the engine significantly.

Charge warning light

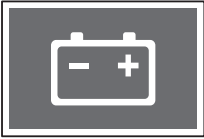

The charge warning light turns on when the vehicle battery is depleted or the charging system is abnormal.

Caution

- If the charge warning light turns on, it indicates that the charging system is abnormal. Have your vehicle checked and serviced at a KG Mobility authorized service center.

Notice

- Even if the charge warning light does not turn on, the engine may not be started if the battery is not charged smoothly due to insufficient tension of the engine fan belt.

Door open warning light



The door open warning light turns on when a door or the tailgate is opened or not closed completely.

Warning

- Confirm that all doors and the tailgate are closed completely before driving. Driving the vehicle with a door or the tailgate opened may cause a serious risk to the safety of occupants.

Engine hood open warning light



The engine hood open warning light turns on when the engine hood is opened or not closed completely.

Warning

- Confirm that the engine hood is closed completely before driving. If you drive the vehicle with the engine hood open, the vehicle may get damaged and it may block the driver's vision, causing a serious accident.

SCR warning lamp*



The SCR warning light turns on when the START/STOP switch is in the ON status and it turns off when the engine is started.

This warning light turns on when the level of urea solution is insufficient or the urea system is abnormal.

☞ Refer to "Warning due to low urea solution level" (p.6-63)

Caution

- Driving the vehicle continuously with the SCR warning light turned on may damage the urea system significantly or vehicle operation may not be possible. If this warning light turns on, add urea or have your vehicle checked and serviced at a KG Mobility authorized service center immediately.

Engine overheat warning lamp



If the temperature of the engine coolant is abnormally high, the engine overheat warning lamp blinks and the warning buzzer sounds.

If this warning light turns on, park your vehicle at a safe place immediately and cool down the engine.

☞ Refer to "When the engine is overheated so that the warning light turns on" (p.5-6)

Caution

- If the engine coolant temperature gauge points out near the engine overheating range (H), park your vehicle at a safe place immediately and cool down the engine.
- Driving the vehicle continuously with an overheated engine may damage the engine significantly. Cool down the engine properly and have your vehicle checked and serviced at a KG Mobility authorized service center.

SSPS warning lamp* (w/o EPS)



If the Speed Sensing Power Steering (SSPS) device is abnormal, the SSPS warning light turns on and the steering wheel becomes heavier.

Caution

- If the SSPS warning light turns on or the steering wheel becomes heavier, have your vehicle checked and serviced at a KG Mobility authorized service center.

Notice

- What is Speed Sensing Power Steering (SSPS)?
The SSPS is the device that improves driving convenience and steering safety by making the steering feel of the steering wheel heavier at a high speed and lighter at a low speed.

Electric power steering warning light



The electric power steering warning light turns on when the ignition switch is turned on and turns off when the ignition is turned on.

This warning lamp lights on in the event of faulty electric power steering (EPS) system.



Caution

- If the electric power steering warning light comes on or the steering wheel feels heavy, please have it checked and serviced a KG Mobility Dealer or KG Mobility Authorized Service Center.

Notice

- If you keep the steering wheel turned to the left or right all the way while the vehicle is stationary, the warning light will blink as the steering wheel becomes heavy. This is a safety feature to protect the system and will return to normal after some time.
- The EPS (Electronic Power Steering) system is mounted in the steering handle. This system includes functions to compensate the steering power, interlocking with ESP, the supplementary driving safety system, when cornering or braking on the road with different friction. You may feel some difference in steering when these functions are in operation.

Water separator warning light (DSL only)

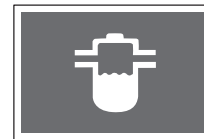

The water separator warning light turns on when the START/STOP switch is in the ON status and it turns off approximately 4 seconds later.

If water in the fuel filter exceeds a prescribed level, the water separator warning light turns on the warning buzzer sounds. Have your vehicle checked and serviced at a KG Mobility authorized service center immediately.



Caution

- Driving the vehicle continuously with the water separator warning light turned on may damage the vehicle fuel system and the engine significantly.
- If low quality fuel that contains a large amount of water is used, the water separator warning light turns on faster. Never use low quality fuel.
- If water in the fuel filter exceeds a prescribed level, the driving force of the engine may decrease in addition to the warning light and the warning buzzer.

Brake warning light

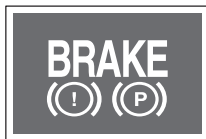

The brake warning light turns on when the START/STOP switch is in the ON status and turns off approximately 4 seconds later. This warning light turns on when the parking brake is applied or the brake fluid is insufficient.

Warning

- If the brake warning light stays on if the parking brake is released, it indicates that the brake fluid is insufficient. Have your vehicle checked and serviced at a KG Mobility authorized service center immediately.
- Driving the vehicle continuously with insufficient brake fluid lowers the brake performance since the pressure of brake fluid cannot be transferred normally.

Notice

Driving the vehicle with insufficient brake fluid causes the brake warning light to operate as follows.

- Turn on: When driving the vehicle at a speed of approximately 10 km/h or less
- Blink: When driving the vehicle at a speed of approximately 10km/h or higher for 2 seconds or more

ABS (Anti-Lock Brake System)* warning light



The ABS warning light turns on when the START/STOP switch is in the ON status and turns off approximately 4 seconds later.

This warning light turns on when the ABS system is abnormal.

Warning

- If the ABS warning light turns on, the ABS function does not operate and only normal brake function operates. In such case, have your vehicle checked and serviced at a KG Mobility authorized service center immediately.

Notice

- A vehicle equipped with the ABS system has the self-diagnosis function to check the internal hydraulic system to see if there is an abnormality by transferring the hydraulic pressure to the internal hydraulic system after the engine is started. At this time, a vibration and a noise may occur at the brake pedal. This indicates that the ABS is functioning normally.

Electronic Brake-Force Distribution (EBD)* warning light



If the EBD system is abnormal, the ABS warning light and the brake warning light turn on at the same time.

In such case, drive the vehicle carefully since the vehicle may become unstable if you apply sudden braking.

Warning

- If the EBD warning light turns on, have your vehicle checked and serviced at a KG Mobility authorized service center immediately.
- If the EBD warning light turns on, the EBD function as well as the ABS function do not operate.

Engine check indicator

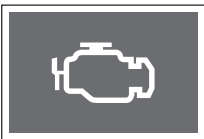

The engine check indicator turns on when the START/STOP switch is in the ON status and turns off the engine is started.

This indicator turns on when various sensors and devices related to engine control (including automatic transmission) are abnormal.

☞ Refer to "Emission reduction device" (p.6-62)



Warning

- If the engine check indicator turns on when you stop the engine, refuel and drive the vehicle again due to an empty fuel tank, the power output may decrease while driving for a certain distance (approximately 30 km).
- If the engine check indicator turns on while driving or occasionally, have your vehicle checked and serviced at a KG Mobility authorized service center.
- If the engine check indicator turns on, the driving performance of the engine may decrease or the engine may stall. This symptom indicates that the vehicle enters the system safety mode in order to protect the vehicle systems. In such case, have your vehicle checked and serviced at a KG Mobility authorized service center.

4WD CHECK warning indicator*



The 4WD CHECK warning indicator turns on when the START/STOP switch is in the ON status and turns off approximately 4 seconds later.

This warning indicator turns on when the 4WD system is abnormal. If the 4WD CHECK warning indicator turns on, have your vehicle checked and serviced at a KG Mobility authorized service center.

4WD LOW indicator*



The 4WD LOW indicator turns on when the START/STOP switch is in the ON status and turns off approximately 4 seconds later.

When you place the 4WD switch in the 4L position, this indicator turns on.

If the indicator blinks temporarily, it indicates that the driving mode is being switched from 4WD HIGH (4H) to 4WD LOW (4L).

4WD HIGH indicator*



The 4WD HIGH indicator turns on when the START/STOP switch is in the ON status and turns off approximately 4 seconds later.

When the driving mode is switched to 4WD HIGH (4H), this indicator turns on.

Steering wheel heater indicator*



If you press the Steering wheel heater button with the START/STOP switch in the ON status or while the engine is running, the steering wheel heater indicator turns on or turns off.

Notice

- When the steering wheel heater indicator turns on, the heater ON/OFF status message is displayed on top of the display of the instrument cluster for approximately 5 seconds.

Electronic stability control system (ESP)* ON indicator/warning light



The ESP ON indicator turns on when the START/STOP switch is in the ON status and turns off approximately 4 seconds later.

- Indicator blinks: When the ESP function is activated
- Warning light turns on: When the ESP system is abnormal



Caution

- **If the ESP ON warning lamp turns on, have your vehicle checked and serviced at a KG Mobility authorized service center.**

Electronic stability control system (ESP)*OFF indicator



The ESP OFF indicator turns on when the START/STOP switch is in the ON status and turns off approximately 4 seconds later.

Pressing and holding down the ESP OFF switch (approximately 3 seconds or more) deactivates the ESP function and the ESP OFF indicator turns on.

☞ Refer to "When it is necessary to deactivate the ESP function" (p.4-154)

Low fuel level warning light



If the remaining fuel level is insufficient, the low fuel level warning light turns on. However, the time for the warning light to turn on may vary depending on the vehicle status or the degree of slope.

Refuel before the low fuel level warning light turns on if possible.

If this warning light turns on, do not drive the vehicle for a long distance and refuel immediately.

☞ Refer to "Fuel inlet" (p.3-29)

Notice

- **If you drive the vehicle on a steep road or a bumpy road with low fuel level, the low fuel level warning light may turn on.**

Glow indicator (DSL only)



The glow indicator turns on when the START/STOP switch is in the ON status and turns off after the glow plugs are fully heated. Start the engine after the glow indicator is turned off.

The time taken for preheating may vary depending on the temperature of the engine coolant.

Caution

- If the glow indicator turns on while driving or the engine cannot be started smoothly, have your vehicle checked and serviced at a KG Mobility authorized service center.

Notice

- If the engine has been preheated, the glow indicator may not turn on.

Global warning light*



The global warning light turns on when the START/STOP switch is in the ON status and turns off approximately 4 seconds later.

If the tire pressure monitoring system (TPMS) is abnormal, the global warning light blinks (for approximately 70 seconds) and then stays on. This warning light also turns on if the tire pressure is abnormal (underinflated/overinflated/flat).

 Refer to "Tire pressure monitoring system (TPMS)"* (p.2-26)

Warning

- If the global warning light turns on, be sure to park your vehicle at a safe place and check the tire pressure. If this warning light stays on, have your vehicle checked and serviced at a KG Mobility authorized service center.

Autonomous Emergency Braking (AEB) warning light*



The AEB warning light turns on when the START/STOP switch is in the ON status and turns off approximately 4 seconds later.

If the collision with a front vehicle is expected with the AEB function activated, the AEB warning light operates as follows along with a warning buzzer.

- Blink: The AEB is operating (It operates for 5 second when a collision warning is given.)
 - Turn on: The AEB is abnormal
-  Refer to "Autonomous Emergency Braking (AEB)"* (p.4-160)

Autonomous Emergency Braking (AEB) OFF indicator*



The AEB OFF indicator turns on when the START/STOP switch is in the ON status and it turns off approximately 4 seconds later.

When the AEB is deactivated and the ESP function is disabled, the AEB indicator turns on, stopping the AEB operation.

Hill Descent Control (HDC) ON indicator/warning light*



When you press the HDC switch, the system is switched to the HDC operation ready status and the green HDC indicator turns on.

When you press the HDC switch again, the indicator turns off and the HDC function is deactivated.

The HDC ON indicator operates as follows according to the status.

- Green indicator turns on: The HDC is in ready status.
- Green indicator blinks: The HDC is operating.
- Red warning light turns on: The HDC system is overheated and abnormal.

☞ Refer to "Hill Descent Control (HDC)"* (p.4-155)



Caution

- **When the red warning light turns on, have your vehicle checked and serviced at a KG Mobility authorized service center.**

Lane departure indicator/warning light*



When you press the lane departure warning switch, the lane departure indicator operates as follows according to the vehicle status.

- White indicator turns on: The lane departure system is in ready status (the vehicle speed is below a prescribed speed or the lane is not recognized).
- Green indicator turns on: The lane departure system is operating normally.
- Yellow warning light blinks: There is abnormality in the calibration of the Front Camera Module (FCM).
- Yellow warning light turns on: The lane departure system is abnormal.

☞ Refer to "LDW (Lane Departure Warning)"* (p.4-177)



Warning

- **If the yellow warning light turns on or blinks, have your vehicle checked and serviced at a KG Mobility authorized service center.**

Illumination ON indicator

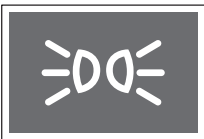

When you turn on the head light or the tail light using the light switch, the illumination ON indicator turns on.

Front fog lamp ON indicator*



When you place the light switch in  (front fog light) position with the head light or the tail light turned on, the front fog light turns on and the indicator turns on.

For a vehicle equipped with the Daytime Running Light (DRL), when you place the light switch in the  (front fog light) position with the switch in the ON status, the front fog light turns on.

Rear fog lamp ON indicator*



With the headlights turned on, if you rotate the switch in  position, rear fog lights turn on and the switch returns back in front fog light position. Rear and front fog lights turn on simultaneously.

SHB indicator*



The SHB indicator turns on when the START/STOP switch is in the ON status and turns off approximately 4 seconds later.

When you push the switch in the direction of the instrument cluster with the light switch in the AUTO position, the SHB is activated and the indicator turns on.

 Refer to "Smart High Beam (SHB)*" (p.3-37)

Caution

In any of the following cases, the SHB may not operate normally.

- When the vehicle windshield is damaged or contaminated by dust, mist, fog, sticker, snow, etc
- When the lamp of an oncoming vehicle or a vehicle at the front is damaged
- When an oncoming vehicle or a vehicle at the front is out of your front sight
- When an oncoming vehicle and a vehicle at the front are recognized only partially in an intersection or a winding road
- When there is a light source similar to a vehicle lamp or a reflector at the front
- When an illuminator or a reflector is installed in a construction section, etc.

High beam indicator



When you push the light switch in the direction of the instrument cluster and release it, the high beam turns on and the high beam indicator turns on.



Warning

- Driving the vehicle with the high beam turned on may block the vision of the driver in an oncoming vehicle and interfere with safe driving. Therefore, use the high beam only if the surrounding is too dark or it is difficult to predict the front situation when you drive at night.

Turn signal/hazard warning lamp



- When you push the light switch down, the left turn signal blinks.
- When you push the light switch up, the right turn signal blinks.
- When you push the hazard warning lamp switch, the left and right turn signals blink at the same time.

Immobilizer/smart key warning light

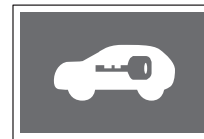

If the smart key system is abnormal or the smart key(transponder) authentication fails, the warning light blinks.



Caution

- If the warning light blinks continuously, have your vehicle checked and serviced at a KG Mobility authorized service center.

WINTER / SPORT indicator lamp (W/EPS)



Pressing the drive mode switch in normal driving condition will change the mode as follows:

- NORMAL → SPORT → WINTER → NORMAL

WINTER mode is a function to minimize slippage when starting off on the slippery road surface in winter.

Caution

- If both the WINTER and SPORT mode indicators are lit simultaneously because of the system failure, have the system checked and serviced by a KG Mobility Dealer or KG Mobility Authorized Service Center.

Notice

- There is no indicator lamp for NORMAL driving.

Winter mode indicator* (W/O EPS)



When you press the mode switch “W” next to the gear shift lever, the mode is switched to the winter mode and the winter mode indicator turns on.

The winter mode is used to reduce the driving wheel slips when you drive the vehicle on a slippery road in winter.

Power mode indicator* (W/O EPS)



Pressing the mode switch (E → P → W) on the switch panel located to the left switch cluster once turns on the power mode indicator.

Caution

- If both the power mode and winter mode indicators flash simultaneously because of the system failure, see a KG Mobility Authorized Service Center and have the vehicle serviced.

ECO indicator (W/O EPS)



The ECO indicator is available in the vehicles with A/T. This indicator comes on in the instrument cluster when the ignition is changed to IGN ON.

The driving mode switch is installed on the left side of the shift lever. Each time this switch is pressed, the indicator turns on in the order of ECO (E) → POWER (P) → WINTER (W).

Notice

- When the ignition switch is turned off and back on, the system shifts to E (ECO) mode without returning to the selected driving mode before turning off the ignition.

ISG indicator/warning lamp



Depending on the ISG operation status, the ISG indicator and warning lamp are operated as follows:

- Green indicator ON : Engine stops due to system operation
- Amber warning lamp ON : faulty ISG system



Caution

- **If the amber warning lamp is lit, have the vehicle checked and serviced at a KG Mobility Dealer or KG Mobility Authorized Service Center.**

ISG OFF indicator



When you press the ISG ON/OFF switch, the indicator is lit. Press the switch again to turn off the indicator.

If you do not want to use the ISG system, press the ISG ON/OFF switch to turn off the ISG system.

Over speed warning light (GCC only)



The warning light flashes with repeated (5 times) buzzer sound when the vehicle speed exceeds 120 km/h.

If the warning light flashes, slow down for your own safety.

Master symbol (Supervision type)



If the vehicle has a warning message, the master symbol will illuminate.



If the master symbol is illuminated, be sure to check the vehicle warning message.



Notice

- **You can check the vehicle warning message(s) in the User Settings in the instrument cluster.**
- **When the warning message is not found, the corresponding item is not displayed.**

Main menu



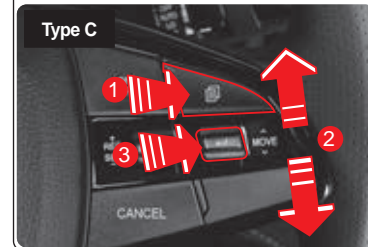
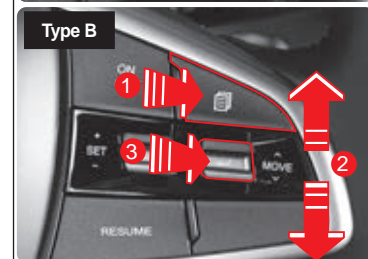
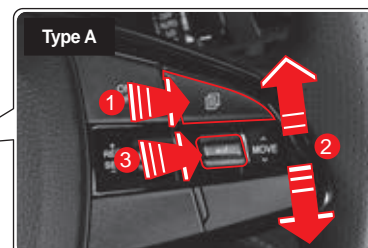

You can check the driving information of the vehicle including mileage and driving time or change the settings through the main menu from the display of the instrument cluster.

- 1 Press the  (menu) button on the right side of the steering wheel.
The display moves to the main menu list.
- 2 Move to the desired submenu by raising or lowering the moving lever.
- 3 Enter the menu or change the setting by pressing the  (selection) button briefly.
Pressing and holding down the  (selection) button resets the driving information of the vehicle.

Item	Switch operation	Function
	Short press	Move to main menu
	Tap up/down	Navigate through sub modes (menus)
	Short press	Enter menu Check settings Select settings
	Long press	Reset selected item



Main menu list

Main menu	Description
 Trip computer information	<ul style="list-style-type: none"> • Driving Distance A/AVG. Speed/Driving Time • Driving Distance B/AVG. Speed/Driving Time • After Departure • Drive Range/AVG. Fuel/Instantaneous fuel economy display • ISG cumulative time display • Display the status of the tire pressure monitoring system (TPMS) • Display the urea level
 Digital speedometer	<ul style="list-style-type: none"> • Display the current vehicle speed in digital numbers.(two different modes)
 Driving assist Menu	<ul style="list-style-type: none"> • Driver assistance system operation status display (LDW / LKA/ ELK) • Driver attention alert level display
 AV screen	<ul style="list-style-type: none"> • Display audio (AV)-linked screen
 User settings	<ul style="list-style-type: none"> • Driving Assist • Dashboard Settings & Info • Vehicle Settings • Reset All Settings

Trip computer information

Distance to empty/average fuel economy/Instantaneous fuel economy

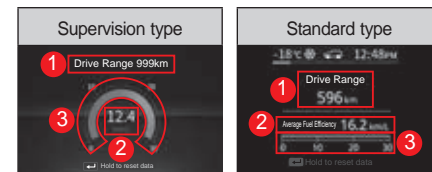

1 Distance to empty

The distance that the vehicle can travel calculated based on the remaining fuel level, average fuel economy and accumulated driving pattern is displayed.

The display range is between 0 km and 1,500 km and “----” blinks if the distance to empty is less than 50 km.

Caution

- Actual fuel level remaining in the fuel tank may be different from the fuel level calculated by the trip computer due to factors including the horizontal condition and driving conditions of the vehicle. Use the distance to empty only for reference purpose and refuel before the low fuel level warning light turns on.

Notice

- In the supervision type instrument cluster, the distance to empty is indicated in yellow if it is approximately 100 km or less, and when “---” is displayed, the color changes to red.

2 Average fuel economy

The average fuel economy calculated using the total amount of fuel used and the mileage since it was reset to “---” is displayed.

It indicates the distance (km) traveled using 1 liter of fuel, and the value on the screen is updated every 10 seconds.

The average fuel efficiency is calculated continuously as long as the engine is running even if the vehicle is not actually driven.

3 Instantaneous fuel economy

The instantaneous fuel economy is calculated based on the mileage and the amount of fuel consumption.

It is displayed when the vehicle is driven at a speed of 10 km/h or higher and the value to be displayed ranges between 0 km/L and 30 km/L.

Resetting the average fuel economy

Press and hold down the  (select) button in the current mode.

The average fuel economy is reset and “---” is displayed, and when the vehicle is driven for a certain distance, the average fuel economy is displayed.

Notice

- You can set the fuel economy to reset according to the vehicle condition (when starting the engine, when refueling). Automatic average fuel economy reset can be set from  (User Settings) → instrument cluster settings & information → Automatic average fuel economy reset on the instrument cluster.

Mileage/average speed/driving time



1 Mileage (A/B)

The distance that the vehicle traveled (km), average speed (km/h) and driving time (hh:mm) are displayed.

The distance to be displayed ranges between 0.0 km and 9999.9 km.

When the distance exceeds 9999.9 km, it returns to 0.0 km.

2 Average speed (A/B)

The average speed calculated based on the time and distance and it is updated every 10 seconds.

3 Driving time (A/B)

The time to be displayed ranges between 0:00 and 99:59, and when the time exceeds this range, it returns to 0:00.

Resetting the mileage/average speed/driving time

Press and hold down the  (select) button in the current mode.

The average speed is reseted to “---” and the driving time is reseted to “0:00”.

Driving information after departure

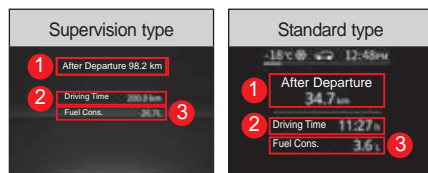

The mileage traveled after the engine is started (km), departure time (hh:mm), driving time (hh:mm) and fuel consumption (L) are displayed.

1 After departure

Total accumulated distance traveled after the engine is started is displayed.

The distance to be displayed ranges between 0.0 km and 9999.9 km.

2 Driving time

The time to be displayed ranges between 0:00 and 99:59, and when the time exceeds this range, it returns to 0:00.

3 Fuel consumption

The total amount of fuel used after the engine is started is displayed in liters (L).

Resetting the driving information after departure

The information resets automatically when you turn off the engine and start the engine again.

ISG cumulative time



1 ISG cumulative time

Displays the cumulative ISG OFF time (engine stop) by the ISG system after startup.

Reset of ISG cumulative time

Press and hold the  (select) switch in current mode.

The ISG cumulative time is reset as "00:00:00".

TPMS status



A message indicating the status of tire pressure is displayed.

- If the tire pressure is normal, “Tire pressure OK” is displayed.
- If the tire pressure is abnormal, the corresponding message according to the degree of abnormal tire pressure is displayed, and this message stays on orlinks depending on the tire pressure condition.

☞ Refer to “Tire pressure monitoring system (TPMS)” (p.2-26)

Notice

- **Approximately 15 seconds after entering the tire pressure mode, it will automatically switch to “Distance to empty / Average fuel economy / Instant fuel economy” mode.**

Urea level



Displays the remaining amount of urea.

Warning

- **If the level 1 warning occurs, replenish at least 6 L of urea immediately. (Condition for canceling the warning)**
- **If the level 2 warning occurs, replenish at least 10 L of urea immediately. (Condition for preventing the occurrence of level 3 warning and canceling the restriction of restarting)**

☞ Refer to “Warning due to low urea solution level” (p.6-63)

Notice

- **In the supervision type instrument cluster, the urea levels 1 and 2 are displayed in red and the urea level 3 or higher are displayed in blue.**
- **The capacity of the urea tank applied to this vehicle is up to 25 L, and up to 20 L is displayed on the instrument cluster.**
- **The urea inlet is located on the right side of the fuel inlet.**

Digital speedometer

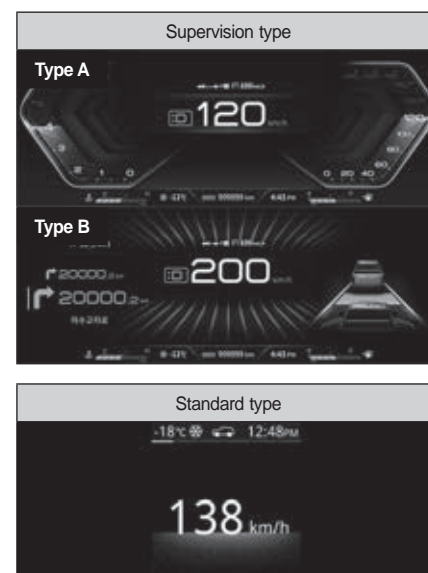

- Displays the current vehicle speed in digital numbers.
 - Supervision type: Two designs are provided.
 - Standard type: One design is provided.

Driving assist



When detecting the lanes according to the vehicle condition, the detected lane is displayed in white and alarm can be issued at the detected lane.

Depending on the operating system, the front vehicle is displayed.

The following are the systems that can display the front vehicle in the driving assistance menu:

- Lane departure warning (LDW)
- Lane keeping assistance (LKA)
- Emergency Lane Keeping (ELK)
- LKA hands-off display
- Auto cruise

Driver attention alert



The driver's "Cautious driving level" is displayed in 5 steps and the driver can determine his/her own current cautious driving level.





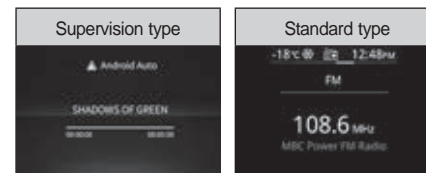





The "Cautious driving level" is lowered to a poor level according to the driver's travel pattern analysis and when driving for a long period of time without rest.

AV screen



The audio (AV) screen linked with the audio (AV) system is displayed.

The image displayed on the position of main menu at the top varies as follows depending on the mode or the function that is used currently.

Image	Mode/function
	Radio mode
	i-Pod mode
	Bluetooth music playback mode
	USB mode
	USB/SD photo mode
	Bluetooth hands-free mode
	Oncar (Smart mirroring)
	Connectivity (Apple Car Play mode)
	USB/SD video mode
	USB/SD music mode
	MY MUSIC
	Android Auto

User settings

※ The menu configuration may vary according to the instrument panel specifications.

Dashboard Lighting

User Settings menu	Level 1	Level 2	Level 3
Dashboard Lighting	Graphic pop-up	-	-
	HELP	-	-

User Settings menu	Level 1	Level 2	Level 3
Driving Assist Setting	Front Safety Aid	AEBS <input checked="" type="checkbox"/>	Tick/not tick (AEBS OFF warning lamp ON when not tick)
		Forward Collision Sensitivity >	<input checked="" type="radio"/> SLOW <input type="radio"/> MEDIUM <input type="radio"/> FAST
		LDW & LKA Setting	<input checked="" type="radio"/> LDW <input type="radio"/> LKA <input type="radio"/> ELK <input type="checkbox"/> Lane departure control
		Adaptive Cruise Level	<input checked="" type="radio"/> COMFORT <input type="radio"/> NORMAL <input type="radio"/> DYNAMIC
		Intelligent Adaptive Cruise <input checked="" type="checkbox"/>	Tick / Untick

User Settings menu	Level 1	Level 2	Level 3
Driving Assist Setting	Front Safety Aid	TSR <input checked="" type="checkbox"/>	Tick / Untick
		TSR Warning <input checked="" type="checkbox"/>	Tick / Untick
		Front Vehicle Start Warning <input checked="" type="checkbox"/>	Tick / Untick
		Driver Attention Warning (DAW) <input checked="" type="checkbox"/>	Tick / Untick
		Safety Distance Warning (SDW) <input checked="" type="checkbox"/>	Tick / Untick
		HELP	-
	Rear Side Safety Aid	Rear Side Warning and Collision Assist	<input checked="" type="radio"/> OFF <input type="radio"/> Collision Warning <input type="radio"/> Collision Assist
		Rear Cross Traffic Warning & Collision Assist	<input checked="" type="radio"/> OFF <input type="radio"/> Collision Warning <input type="radio"/> Collision Assist
		Safety Exit Warning <input checked="" type="checkbox"/>	<input checked="" type="radio"/> OFF <input type="radio"/> ON
		HELP	-
	Parking Safety Aid	Front Obstacle Warning Auto-On <input checked="" type="checkbox"/>	Tick / Untick
		HELP	-

Dashboard Settings

User Settings menu	Level 1	Level 2	Level 3
Dashboard Settings	Dashboard Settings & Info	Fuel Economy Reset	<input checked="" type="radio"/> OFF <input type="radio"/> Reset After Refueling <input type="radio"/> Reset After Ignition
		Fuel Economy Unit	<input checked="" type="radio"/> km/L <input type="radio"/> L/100km
		Temperature Unit	<input checked="" type="radio"/> °C <input type="radio"/> °F
		Tire Pressure Unit	<input checked="" type="radio"/> psi <input type="radio"/> kPa <input type="radio"/> bar <input type="radio"/> kgf/cm ²
		Warning Light Info	-
		HELP	-
	Checkup Alert	Activate Checkup Alert <input type="checkbox"/>	Tick / Untick (Sub items activated when ticked)
		Oil & filter	Not set ~ 99,500 km (500 km in increments)
		Tire	
		Others	
		HELP	-

User Settings menu	Level 1	Level 2	Level 3	
Dashboard Settings	Sound	Warning Sound Type	<input checked="" type="radio"/> Basic <input type="radio"/> Natural <input type="radio"/> Classic <input type="radio"/> Trendy <input type="radio"/> Korean <input type="radio"/> Luxury	
		Turn Signal Sound Volume	Level 1 / 2 / 3	
		Dashboard Voice Volume		
		Blind Spot System Sound	BSW audible alert	<input checked="" type="checkbox"/>
			RCTW audible alert	<input type="checkbox"/>
			SEW audible alert	<input checked="" type="checkbox"/>
Welcome & Goodbye Sound	<input checked="" type="checkbox"/>	-		
HELP		-		

Display settings





User Settings menu	Level 1	Level 2	Level 3	Initialization value / B+ reset value
Display Settings	Day/Night Mode	<input checked="" type="radio"/> Automatic Switching <input type="radio"/> Day Mode <input type="radio"/> Night Mode	-	AUTO / Last mode
	HELP		-	-





Vehicle settings

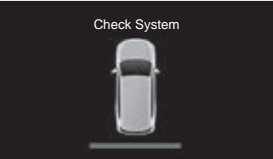
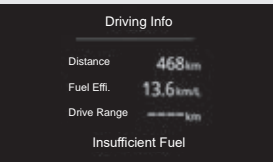



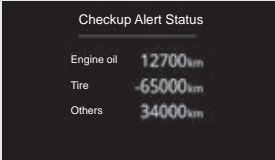

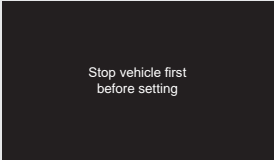
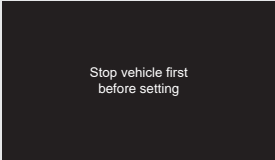
User Settings menu	Level 1	Level 2	Level 3	
Vehicle Settings	Door/Tailgate	Auto Lock	<input checked="" type="radio"/> OFF <input type="radio"/> Driving <input type="radio"/> Shifting to R,N,D	
		Auto Unlock	<input checked="" type="radio"/> OFF <input type="radio"/> Engine Off <input type="radio"/> Shifting to P	
		Auto Lock Speed Setting	<input checked="" type="radio"/> 10km/h <input type="radio"/> 20km/h <input type="radio"/> 30km/h <input type="radio"/> 40km/h <input type="radio"/> 50km/h	
		Lock/Unlock Sound	<input checked="" type="checkbox"/>	-
		Press key twice to unlock	<input checked="" type="checkbox"/>	-
		Steering Wheel Alignment Alert	<input checked="" type="checkbox"/>	Tick / Untick
	Convenience	Wiper Mode Display	<input checked="" type="checkbox"/>	Tick / Untick
		Light Mode Display	<input checked="" type="checkbox"/>	Tick / Untick
		Approach Welcome	<input checked="" type="checkbox"/>	Tick / Untick
		Auto Approach Welcome	<input checked="" type="checkbox"/>	Tick / Untick
		Long-Term Parking	<input checked="" type="checkbox"/>	Tick / Untick
		HELP		-
	Reset All Settings	Yes/No	-	-

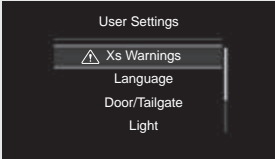







Message/pop-up message on the display of the instrument cluster







Message on the display of the instrument cluster



Item	Advanced type	Standard type	Operating conditions
Welcome message & sound			<ul style="list-style-type: none"> • If you tick the box at Sound → Welcome & Goodbye Sound display under User Settings in the instrument cluster, this message is displayed for 4 seconds when the theft deterrent mode is deactivated and the driver door is open and closed. • If you turn the ignition switch to on while the message is displayed, the screen display disappears and the welcome sound plays to the end.
SYSTEM CHECK	-		<ul style="list-style-type: none"> • If the ignition switch is turned on, this message is displayed for 4 seconds once. • If the message stays on, have the vehicle serviced at a KG Mobility Dealer or KG Mobility Authorized Service Center.
Driving Information	-		<ul style="list-style-type: none"> • When  (User Settings) Instrument Cluster Settings & Information → Show Driving Information is ticked in the instrument cluster, the 'Driving Information' message will be displayed for approximately 4 seconds when the ignition is turned off. • The "Low fuel" message will be displayed at the bottom of the screen only when the low fuel level warning lamp is illuminated.







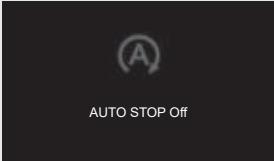
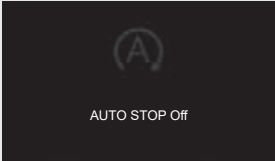
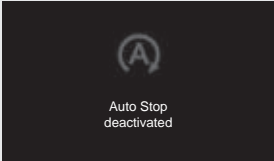
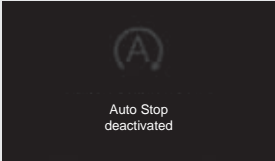
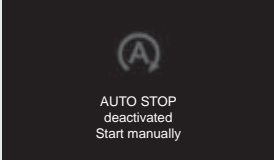
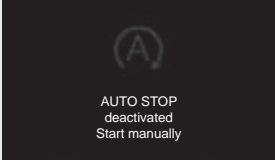
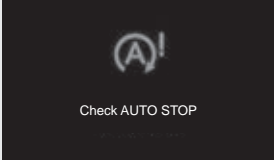





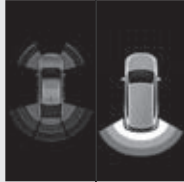



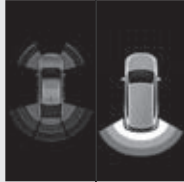



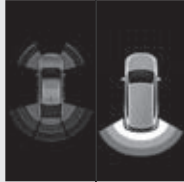

Item	Advanced type	Standard type	Operating conditions
Service Interval Alert	-		<ul style="list-style-type: none"> If you tick Enable Service Interval Notification in  (User Settings), 'Service Interval Notification' message is displayed when the ignition is turned off. However, this message is not displayed when the distance left to the next service is over 300 km. When it is past the due date, the number is preceded by "-".
Instrument Cluster Settings			<ul style="list-style-type: none"> If a vehicle speed greater than 0 km/h is detected after you enter the User Settings menu, LCD display shows this warning message for 5 seconds. However, the instrument cluster illumination, driving assist and vehicle warning menus are excluded.
ICE Warning Lamp		-	<ul style="list-style-type: none"> The ICE warning pop-up (1) is displayed as a pop-up message for 5 seconds when the ambient temperature falls 3°C or below. The ICE warning symbol (2) is displayed in the ambient temperature display at top of the instrument panel. ICE warning symbol is turned off when the ambient temperature is 5°C or higher.
Vehicle Warning Log			<ul style="list-style-type: none"> You can see the warning messages from the vehicle in the instrument cluster (User Settings). <ul style="list-style-type: none"> When the warning message is available at the vehicle, the custom symbol is changed to the master symbol. When the warning message is not available, the corresponding item is not displayed.







Item	Advanced type	Standard type	Operating conditions
Smart Key Warning	 <p>Smart key is inside</p>	 <p>Smart key is inside</p>	<ul style="list-style-type: none"> When you about to close the door with another authenticated smart key or door handle switch while all the doors are closed and the authenticated smart key is inside the vehicle, this message will be displayed for 5 seconds.
	 <p>Smart key is not inside</p>	 <p>Smart key is not inside</p>	<ul style="list-style-type: none"> This message is displayed if no smart key is detected inside the vehicle with the ignition switch ON or engine running.
	 <p>Press START with smart key</p>	 <p>Press START with smart key</p>	<ul style="list-style-type: none"> If the ignition switch is pressed and there is no valid smart key detected inside the vehicle, this message is displayed for 5 approximately seconds.
	<p>Replace key battery. Smart Door Auto Lock is deactivated. Reset after replacement.</p>	<p>Replace key battery. Smart Door Auto Lock is deactivated. Reset after replacement.</p>	<ul style="list-style-type: none"> If low smart key battery is detected with AUTO LOCK function activated, this message is displayed on the LCD screen for 10 sec. This message is displayed for 10 sec. when the AUTO LOCK function is deactivated → activated with low smart key battery.





Item	Advanced type	Standard type	Operating conditions
Smart Key Warning	 <p>Check smart key system</p>	 <p>Check smart key system</p>	<ul style="list-style-type: none"> • If the smart key module does not receive any signal or receives faulty/incorrect signals from the vehicle power supply control or ignition switch after the smart key authentication, this message is displayed for 5 approximately seconds. • If the message stays on, have the vehicle serviced at a KG Mobility Dealer or KG Mobility Authorized Service Center.
	 <p>Replace smart key battery</p>	 <p>Replace smart key battery</p>	
Ignition Switch Warning	 <p>Press on brake pedal and start engine</p>	 <p>Press on brake pedal and start engine</p>	<ul style="list-style-type: none"> • For the vehicles with A/T, when the ignition switch is turned to ACC position a second time by pressing the ignition switch continuously without depressing the brake pedal, this message is displayed for about 5 seconds. • This message is to inform the driver that the brake pedal should be depressed and the ignition switch be pressed in order to start the engine.
	 <p>Shift to P or N</p>	 <p>Shift to P or N</p>	







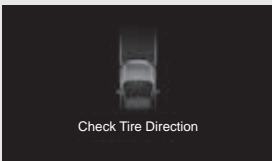

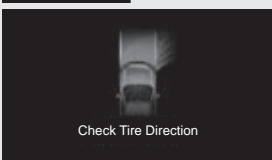
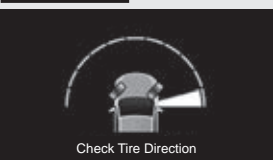
Item	Advanced type	Standard type	Operating conditions
Ignition Switch Warning	 <p>Shift to "P" before turning it off</p>	 <p>Shift to "P" before turning it off</p>	<ul style="list-style-type: none"> • This message is displayed for approximately 5 seconds when the driver turns power off with the transmission selector lever not in P position. • This message is to inform the driver that the transmission selector lever must be in the P position and the ignition switch must be pressed to turn off the power.
	<p>Turn it off to prevent battery drain</p>	<p>Turn it off to prevent battery drain</p>	<ul style="list-style-type: none"> • In order to prevent the battery from being discharged, this message is displayed for approximately 5 seconds when ignition switch is in ACC position for 12 minutes or longer or the driver's door is open with ACC ON.
ISG System	 <p>AUTO STOP 02:03</p>	 <p>AUTO STOP 23:47</p>	<ul style="list-style-type: none"> • The message indicating the cumulative time that the engine has stopped is displayed while the ISG system is normally operating.
	 <p>Starting automatically</p>	 <p>Starting automatically</p>	<ul style="list-style-type: none"> • This message is displayed when the engine stops and then is automatically restarted while the ISG system is normally operating.

Item	Advanced type	Standard type	Operating conditions
ISG System			<ul style="list-style-type: none"> Pressing the ISG OFF button deactivates the ISG system and the message indicating that the system has been turned off is displayed for approximately 5 seconds. However, the ISG OFF indicator will be illuminated even if the corresponding message is not displayed according to the pop-up priority.
			<ul style="list-style-type: none"> If the current status of the vehicle does not meet the ISG system operating conditions, this message is displayed.
			<ul style="list-style-type: none"> The message is displayed when the engine stops and is not automatically restarted depending on the vehicle status while the ISG system is normally operating.
			<ul style="list-style-type: none"> This message is displayed in the event of the faulty ISG system. If the message stays on, have the system checked and serviced at a nearest KG Mobility Authorized Service Center.







Item	Advanced type	Standard type	Operating conditions						
Front/rear Obstacle Detection	<p data-bbox="282 216 493 244">In R (reverse) position</p> <div data-bbox="282 259 854 715"> <table border="1"> <tr> <td data-bbox="282 259 467 479"> <p data-bbox="354 268 396 291">LV3</p>  </td> <td data-bbox="477 259 662 479"> <p data-bbox="548 268 591 291">LV2</p>  </td> <td data-bbox="672 259 854 479"> <p data-bbox="743 268 786 291">LV1</p>  </td> </tr> <tr> <td data-bbox="282 495 467 715"> <p data-bbox="354 503 396 526">LV0</p>  </td> <td data-bbox="477 495 662 715"> <p data-bbox="542 503 597 526">Error</p>  </td> <td></td> </tr> </table> </div>		<p data-bbox="354 268 396 291">LV3</p> 	<p data-bbox="548 268 591 291">LV2</p> 	<p data-bbox="743 268 786 291">LV1</p> 	<p data-bbox="354 503 396 526">LV0</p> 	<p data-bbox="542 503 597 526">Error</p> 		<ul style="list-style-type: none"> • Rear PAS (when placing transmission selector lever on R position with ignition switch ON) <ul style="list-style-type: none"> - When the transmission selector lever is moved to the R (reverse) position, an alarm sounds briefly once, and if an obstruction is detected around the vehicle, the position and distance for each sensor is displayed in steps 4 (0-3). - In step 1 of the rear PAS, the detection result of the front PAS is not displayed, and in step 0, only the shape of the vehicle is displayed. - If an obstacle detection sensor is faulty, "?" is displayed on the sensor.
	<p data-bbox="354 268 396 291">LV3</p> 	<p data-bbox="548 268 591 291">LV2</p> 	<p data-bbox="743 268 786 291">LV1</p> 						
<p data-bbox="354 503 396 526">LV0</p> 	<p data-bbox="542 503 597 526">Error</p> 								
<p data-bbox="282 753 493 782">In D (drive) position</p> <div data-bbox="282 797 854 1017"> <table border="1"> <tr> <td data-bbox="282 797 467 1017"> <p data-bbox="354 805 396 829">LV3</p>  </td> <td data-bbox="477 797 662 1017"> <p data-bbox="548 805 591 829">LV2</p>  </td> <td data-bbox="672 797 854 1017"> <p data-bbox="737 805 792 829">Error</p>  </td> </tr> </table> </div>		<p data-bbox="354 805 396 829">LV3</p> 	<p data-bbox="548 805 591 829">LV2</p> 	<p data-bbox="737 805 792 829">Error</p> 	<ul style="list-style-type: none"> • Front PAS (when placing transmission selector lever on D position with ignition switch ON) <ul style="list-style-type: none"> - If an obstacle is detected in front of the vehicle, the position and distance are displayed in steps 2 and 3, and not in steps 1 and 0. - The front PAS does not operate if the vehicle speed exceeds 15 km/h. <ul style="list-style-type: none"> ☞ Refer to "Parking assist system*" (p.4-194) - If an obstacle detection sensor is faulty, "?" is displayed on the sensor. 				
<p data-bbox="354 805 396 829">LV3</p> 	<p data-bbox="548 805 591 829">LV2</p> 	<p data-bbox="737 805 792 829">Error</p> 							

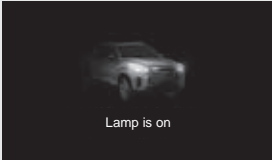
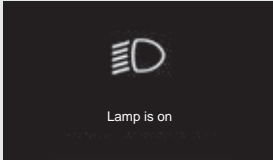
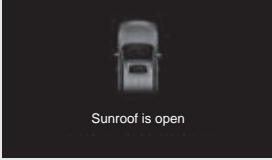
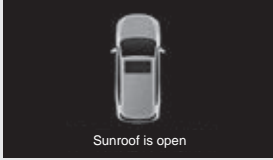
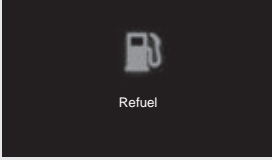
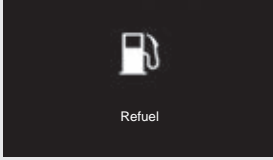
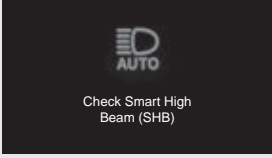
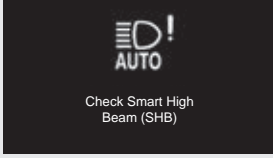





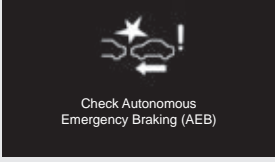

Item	Advanced type	Standard type	Operating conditions
Door/Engine Hood/Tailgate Open Indication	<p style="text-align: center;">Driver door open</p> 	<p style="text-align: center;">Passenger door open</p> 	<ul style="list-style-type: none"> • Advanced type <ul style="list-style-type: none"> - When the vehicle's door, engine hood, or tailgate is open, the corresponding image is displayed in animation. • Standard type <ul style="list-style-type: none"> - Displays which door is open. - When the hood or tailgate is open, the corresponding position flashes. • When all doors are closed, the vehicle image with all doors closed is displayed for 1 second. • When the door is open, the door ajar warning lamp is displayed on the LCD screen (main menu symbol position). (changed from main menu symbol to door ajar warning lamp)
	<p style="text-align: center;">Rear left door open</p> 	<p style="text-align: center;">Rear right door open</p> 	
	<p style="text-align: center;">Hood open</p> 	<p style="text-align: center;">Tailgate open</p> 	
	<p style="text-align: center;">Standard type</p> 		

Item	Advanced type	Standard type	Operating conditions
Wheel Alignment Display	<p>LH level 5</p> 	<p>LH level 5</p> 	<ul style="list-style-type: none"> • When the ignition switch is turned to ON from OFF position, the message is displayed at levels 1 to 5 according to the wheel alignment level. No message will be displayed if the wheel alignment level is 0. • It will be displayed for 5 seconds up to level 2, and from level 3 the message will remain until the conditions are met. • A message is displayed only if the transmission selector lever is in the P (park) or N (neutral) position.
	<p>Level 0</p> 	<p>Level 0</p> 	
	<p>RH level 5</p> 	<p>RH level 5</p> 	

Item	Advanced type	Standard type	Operating conditions
ESP System Warning	 <p>Check Electronic Stability Control (ESC)</p>	 <p>Check Electronic Stability Control (ESC)</p>	<ul style="list-style-type: none"> In the event of an ESP system failure, a warning lamp will illuminate and a message will be displayed after 3 seconds of engine start.
EBD System Warning	 <p>Check Electronic Brake force Distribution (EBD)</p>	 <p>Check Electronic Brake force Distribution (EBD)</p>	<ul style="list-style-type: none"> In the event of an EBD system failure, a warning lamp will illuminate and a message will be displayed after 3 seconds of engine start.
ABS Warning	 <p>Check Anti-lock Brake System (ABS)</p>	 <p>Check Anti-lock Brake System (ABS)</p>	<ul style="list-style-type: none"> In the event of an ABS failure, a warning lamp will illuminate and a message will be displayed after 3 seconds of engine start.
Engine Oil Level Check	 <p>Check engine oil level</p>	 <p>Check engine oil level</p>	<ul style="list-style-type: none"> If engine oil level is low or engine oil pressure is abnormal, a warning lamp will illuminate and a message will be displayed after 3 seconds of engine start.

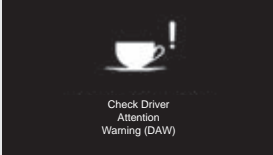

Item	Advanced type	Standard type	Operating conditions
Exterior Lamp ON			<ul style="list-style-type: none"> This message is displayed if the exterior lamp is on when the driver's door is open after the ignition has been turned off.
Sunroof Open Warning			<ul style="list-style-type: none"> A message will be displayed if the sunroof is open after the ignition is turned off.
Low Fuel Level			<ul style="list-style-type: none"> If the fuel level is low, a warning lamp will illuminate and a message will be displayed after 3 seconds of engine start.
Low Fuel Level (DTE less than 30 km)			<ul style="list-style-type: none"> This message is displayed at the point when the distance to empty is less than about 30km.
Smart High Beam (SHB) System Warning			<ul style="list-style-type: none"> In the event of a smart high beam (SHB) system failure, this message will be displayed after 3 seconds of engine start.

Item	Advanced type	Standard type	Operating conditions
Autonomous Emergency Braking (AEB)	 <p>Collision Warning</p>	 <p>Collision Warning</p>	<ul style="list-style-type: none"> When the operating conditions for the autonomous emergency braking system (AEB) are met, a "Collision Alert" message is displayed for 5 seconds. The AEB warning lamp also flashes for 5 seconds. If the conditions for displaying warning message are met again during the 5 seconds of the message display, the new warning message will be displayed for 5 seconds with the same flashing of the indicator.
	 <p>Emergency Braking Off</p>	 <p>Emergency Braking Off</p>	<ul style="list-style-type: none"> This message is displayed after the vehicle has stopped by the activation of emergency braking (maximum brake control) by the 3rd warning of AEB.
	 <p>AEBS</p> <p>Check Autonomous Emergency Braking (AEB)</p>	 <p>Check Autonomous Emergency Braking (AEB)</p>	<ul style="list-style-type: none"> If there is a fault in the AEB 3 seconds after the engine start, this warning message is displayed for 5 seconds.
	 <p>Camera cannot work due to dirty windshield</p>	 <p>Camera cannot work due to dirty windshield</p>	<ul style="list-style-type: none"> This message is displayed when the front camera module (FCM) cannot detect the lane markings, preceding vehicles, people, etc. because of the dirt or debris on the windshield glass.



Item	Advanced type	Standard type	Operating conditions
Driver Attention Warning (DAW)			<ul style="list-style-type: none"> This message is displayed when the driver untick the box at Driving assistance > Driver attention alert under (User Settings) in the instrument cluster and select main menu (Driving Assistance menu).
			<ul style="list-style-type: none"> The driver attention warning (DAW) displays the driver's "cautious driving level" in the 5 bars (5 levels) and if there is no bar at the bottom, the driver will be alerted with a warning message and buzzer. (However, the alarm level will be initialized when the engine is switched off or the driver's seat belt is unfastened and driver's door is open)
			
			
			<ul style="list-style-type: none"> This message is displayed in the event of the faulty DAW system. If the message stays on, have the system checked and serviced at a nearest KG Mobility Authorized Service Center.

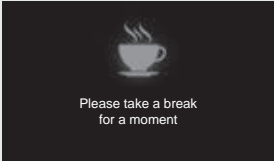
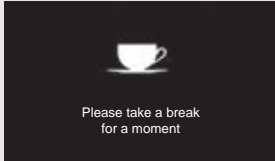
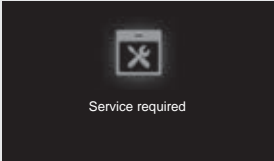
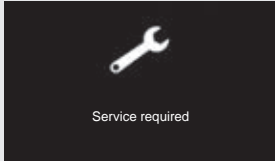

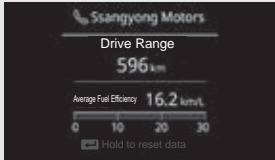

Driver Attention Warning (DAW)

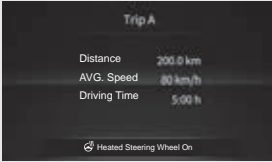
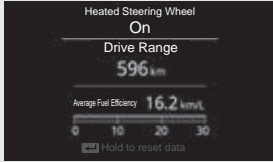
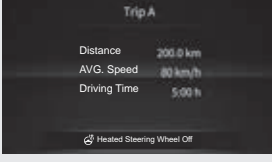
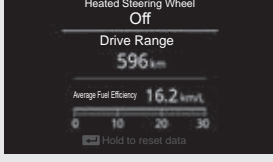
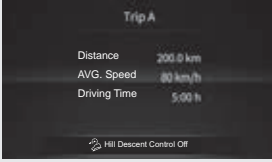
A function that warns and encourages the driver to get some rest by displaying the warning level based on the result of analyzing the vehicle information and the driver's driving pattern.

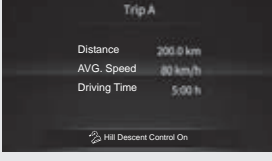
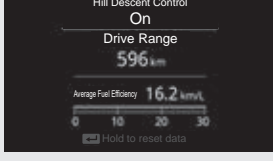





Item	Advanced type	Standard type	Operating conditions
Break Time Alert			<ul style="list-style-type: none"> • The message which recommends taking a break is displayed for approximately 10 seconds for your safety after driving for some time. • Alert interval: <ul style="list-style-type: none"> - Only vehicles without DAA will display the message every 2 hours from the time the engine is first started with the ignition switch ON. - For vehicles with DAA, the warning pop-up is displayed by the DAA system.
Service Interval Alert			<ul style="list-style-type: none"> • If the Enable Service Interval Alert check box is ticked under (User Settings) in the instrument cluster, when the distance to empty reaches 0 km, a message is displayed once (when the ignition switch is switched from OFF to ON).
Bluetooth Phone Call Hold			<ul style="list-style-type: none"> • When you receive a call with hands-free connected, the name or phone number will still be displayed until the signal persists. If the name and phone number are received at the same time, only the name is displayed. • In AV screen (main menu), the pop-up message is not displayed.

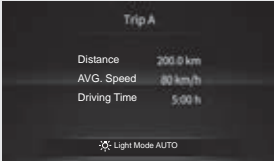
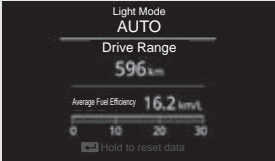
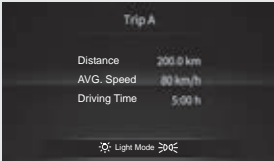
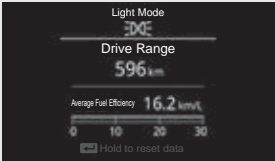
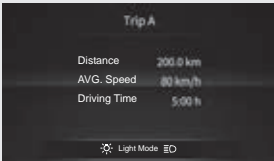
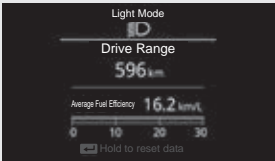
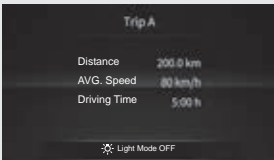
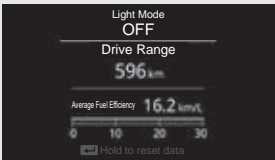

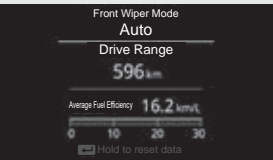
Item	Advanced type	Standard type	Operating conditions
Drive Mode/ Driving Mode			<ul style="list-style-type: none"> • Drive Mode (W/EPS) “ECO”, “SPORT” and “WINTER” are displayed depending on the operation of the drive mode switch during drive. • Driving Mode (W/O EPS) “NORMAL”, “SPORT” and “WINTER” are displayed depending on the operation of the driving mode switch during driving.
			
			

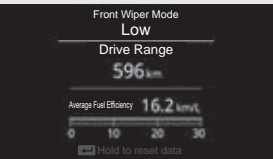

Item	Advanced type	Standard type	Operating conditions
Heated Steering Wheel	 <p>Trip A</p> <p>Distance 200.0 km AVG. Speed 80 km/h Driving Time 5:00 h</p> <p>Heated Steering Wheel On</p>	 <p>Heated Steering Wheel On</p> <p>Drive Range 596 km</p> <p>Average Fuel Efficiency 16.2 km/L</p> <p>0 10 20 30</p> <p>Hold to reset data</p>	<ul style="list-style-type: none"> This message is displayed for approximately 5 seconds according to the operating status of the heated steering wheel with IGN ON or engine running.
	 <p>Trip A</p> <p>Distance 200.0 km AVG. Speed 80 km/h Driving Time 5:00 h</p> <p>Heated Steering Wheel Off</p>	 <p>Heated Steering Wheel Off</p> <p>Drive Range 596 km</p> <p>Average Fuel Efficiency 16.2 km/L</p> <p>0 10 20 30</p> <p>Hold to reset data</p>	
HDC ON/OFF	 <p>Trip A</p> <p>Distance 200.0 km AVG. Speed 80 km/h Driving Time 5:00 h</p> <p>Hill Descent Control Off</p>	 <p>Hill Descent Control Off</p> <p>Drive Range 596 km</p> <p>Average Fuel Efficiency 16.2 km/L</p> <p>0 10 20 30</p> <p>Hold to reset data</p>	<ul style="list-style-type: none"> This message is displayed for approximately 5 seconds depending on the ON / OFF status of the HDC system. The indicator color may change based on the HDC operation status. <ul style="list-style-type: none"> Green HDC indicator ON: HDC in ready status Green HDC indicator flashing: HDC in operation Red HDC warning lamp ON: HDC overheated and system error
	 <p>Trip A</p> <p>Distance 200.0 km AVG. Speed 80 km/h Driving Time 5:00 h</p> <p>Hill Descent Control On</p>	 <p>Hill Descent Control On</p> <p>Drive Range 596 km</p> <p>Average Fuel Efficiency 16.2 km/L</p> <p>0 10 20 30</p> <p>Hold to reset data</p>	



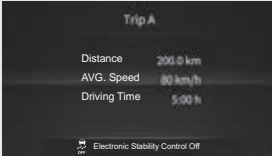
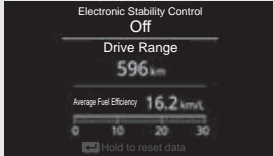
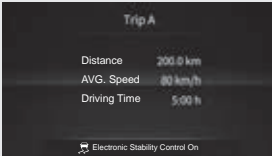



Item	Advanced type	Standard type	Operating conditions
HDC System	 <p data-bbox="350 309 488 338">Check the Hill Descent Control System</p>	 <p data-bbox="651 309 789 338">Check the Hill Descent Control System</p>	<ul data-bbox="894 236 1503 342" style="list-style-type: none"> • If the HDC (Hill Descent Control) system is faulty, this message is displayed. • If the message stays on, have the system checked and serviced at a nearest KG Mobility Authorized Service Center.
	 <p data-bbox="310 497 529 526">Not in Hill Descent Control operating condition.</p>	 <p data-bbox="610 497 829 526">Not in Hill Descent Control operating condition.</p>	<ul data-bbox="894 450 1503 503" style="list-style-type: none"> • If the operating conditions of the HDC system are not met, this message is displayed.

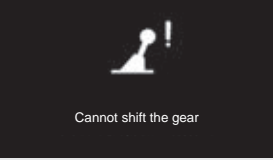
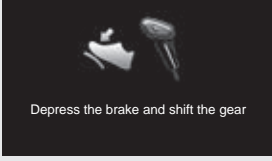
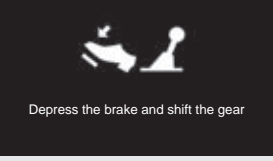
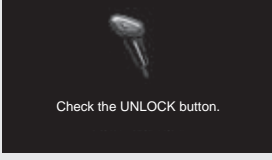
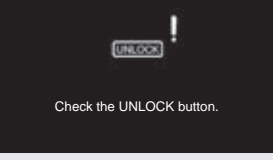

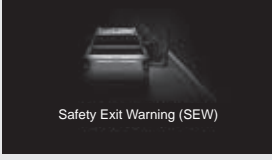

Item	Advanced type	Standard type	Operating conditions
Light Mode	 <p>Trip A</p> <p>Distance 200.0 km AVG. Speed 80 km/h Driving Time 5:00 h</p> <p>Light Mode AUTO</p>	 <p>Light Mode AUTO</p> <p>Drive Range 596 km</p> <p>Average Fuel Efficiency 16.2 km/L</p> <p>0 10 20 30</p> <p>Hold to reset data</p>	<ul style="list-style-type: none"> Depending on the position of the light switch, the current status will be displayed in 4 modes for approximately 5 seconds.
	 <p>Trip A</p> <p>Distance 200.0 km AVG. Speed 80 km/h Driving Time 5:00 h</p> <p>Light Mode D</p>	 <p>Light Mode D</p> <p>Drive Range 596 km</p> <p>Average Fuel Efficiency 16.2 km/L</p> <p>0 10 20 30</p> <p>Hold to reset data</p>	
	 <p>Trip A</p> <p>Distance 200.0 km AVG. Speed 80 km/h Driving Time 5:00 h</p> <p>Light Mode ED</p>	 <p>Light Mode ED</p> <p>Drive Range 596 km</p> <p>Average Fuel Efficiency 16.2 km/L</p> <p>0 10 20 30</p> <p>Hold to reset data</p>	
	 <p>Trip A</p> <p>Distance 200.0 km AVG. Speed 80 km/h Driving Time 5:00 h</p> <p>Light Mode OFF</p>	 <p>Light Mode OFF</p> <p>Drive Range 596 km</p> <p>Average Fuel Efficiency 16.2 km/L</p> <p>0 10 20 30</p> <p>Hold to reset data</p>	

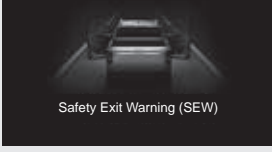





Item	Advanced type	Standard type	Operating conditions
Windshield Wiper Mode	 <p>Trip A</p> <p>Distance 200.0 km AVG. Speed 80 km/h Driving Time 5.00 h</p> <p>Front Wiper Mode Auto</p>	 <p>Front Wiper Mode Auto</p> <p>Drive Range 596 km</p> <p>Average Fuel Efficiency 16.2 km/l</p> <p>0 10 20 30</p> <p>Hold to reset data</p>	<ul style="list-style-type: none"> Depending on the position of the windshield wiper stalk, the current status will be displayed in 4 modes for approximately 5 seconds.
	 <p>Trip A</p> <p>Distance 200.0 km AVG. Speed 80 km/h Driving Time 5.00 h</p> <p>Front Wiper Mode Low</p>	 <p>Front Wiper Mode Low</p> <p>Drive Range 596 km</p> <p>Average Fuel Efficiency 16.2 km/l</p> <p>0 10 20 30</p> <p>Hold to reset data</p>	
	 <p>Trip A</p> <p>Distance 200.0 km AVG. Speed 80 km/h Driving Time 5.00 h</p> <p>Front Wiper Mode High</p>	 <p>Front Wiper Mode High</p> <p>Drive Range 596 km</p> <p>Average Fuel Efficiency 16.2 km/l</p> <p>0 10 20 30</p> <p>Hold to reset data</p>	
	 <p>Trip A</p> <p>Distance 200.0 km AVG. Speed 80 km/h Driving Time 5.00 h</p> <p>Front Wiper Mode Off</p>	 <p>Front Wiper Mode Off</p> <p>Drive Range 596 km</p> <p>Average Fuel Efficiency 16.2 km/l</p> <p>0 10 20 30</p> <p>Hold to reset data</p>	



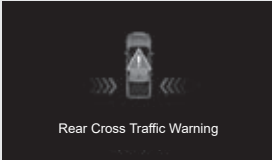

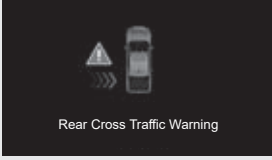

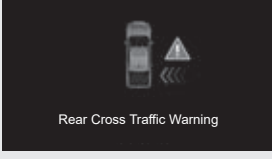
Item	Advanced type	Standard type	Operating conditions
ESP System ON/OFF	 <p>Trip A</p> <p>Distance 200.0 km</p> <p>AVG. Speed 80 km/h</p> <p>Driving Time 5:00 h</p> <p>Electronic Stability Control Off</p>	 <p>Electronic Stability Control Off</p> <p>Drive Range 596 km</p> <p>Average Fuel Efficiency 16.2 km/L</p> <p>0 10 20 30</p> <p>Hold to reset data</p>	<ul style="list-style-type: none"> This message is displayed for approximately 5 seconds depending on the status of the ESP OFF switch.
	 <p>Trip A</p> <p>Distance 200.0 km</p> <p>AVG. Speed 80 km/h</p> <p>Driving Time 5:00 h</p> <p>Electronic Stability Control On</p>	 <p>Electronic Stability Control On</p> <p>Drive Range 596 km</p> <p>Average Fuel Efficiency 16.2 km/L</p> <p>0 10 20 30</p> <p>Hold to reset data</p>	





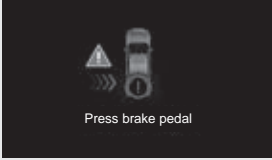

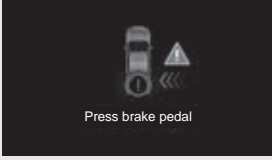
Item	Advanced type	Standard type	Operating conditions
Shift Lever	 <p data-bbox="354 315 482 330">Check the shift lever</p>	 <p data-bbox="657 297 786 312">Check the shift lever</p>	<ul data-bbox="894 265 1500 312" style="list-style-type: none"> • If the message stays on, have the system checked and serviced at a nearest KG Mobility Authorized Service Center.
	 <p data-bbox="354 503 482 518">Cannot shift the gear</p>	 <p data-bbox="657 509 786 524">Cannot shift the gear</p>	<ul data-bbox="894 456 1500 503" style="list-style-type: none"> • If the current status of the vehicle does not meet the shift lever system's shifting conditions, this message is displayed.
	 <p data-bbox="310 695 532 710">Depress the brake and shift the gear</p>	 <p data-bbox="613 695 836 710">Depress the brake and shift the gear</p>	<ul data-bbox="894 647 1500 695" style="list-style-type: none"> • When the electronic shift lever is operated, the message is displayed if the shift lever is operated without the brake applied.
	 <p data-bbox="337 886 505 901">Check the UNLOCK button.</p>	 <p data-bbox="639 886 807 901">Check the UNLOCK button.</p>	<ul data-bbox="894 839 1500 886" style="list-style-type: none"> • If the message stays on, have the system checked and serviced at a nearest KG Mobility Authorized Service Center.

Item	Advanced type	Standard type	Operating conditions
Safety Exit Warning (SEW)	 <p>Safety Exit Warning (SEW)</p>	 <p>Safety Exit Warning (SEW)</p>	<ul style="list-style-type: none"> If you are about to open the door to leave the vehicle when a vehicle is approaching from the rear side, the vehicle exit alert system displays a message and generates a beep sound. However, it operates only when the gear selector lever is in P (park) or N (neutral) position.
	 <p>Safety Exit Warning (SEW)</p>	 <p>Safety Exit Warning (SEW)</p>	
	 <p>Safety Exit Warning (SEW)</p>	 <p>Safety Exit Warning (SEW)</p>	

Item	Advanced type	Standard type	Operating conditions
Blind Spot-Detection Warning (BSW)	 <p data-bbox="337 306 505 338">Check Blind Spot-Detection Warning (BSW)</p>	 <p data-bbox="639 310 807 342">Check Blind Spot-Detection Warning (BSW)</p>	<ul data-bbox="894 248 1500 330" style="list-style-type: none"> • This message is displayed in the event of the faulty BSW system. • If the message stays on, have the system checked and serviced at a nearest KG Mobility Authorized Service Center.
	 <p data-bbox="354 491 483 553">Blind Spot-Detection Warning has been deactivated temporarily</p>	 <p data-bbox="656 483 786 545">Blind Spot-Detection Warning has been deactivated temporarily</p>	<ul data-bbox="894 416 1500 542" style="list-style-type: none"> • This message is displayed when the BSW system is turned on and the sensor can not normally detect the blind spots: when there are foreign materials on the outside or inside of the rear bumper, a trailer or other equipment is installed in the rear of the vehicle, the width of the road is wide, it snows or rains too much and etc.

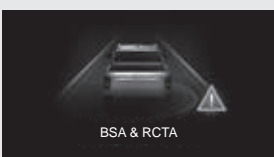
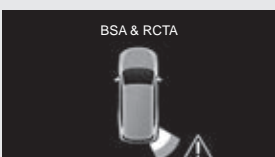



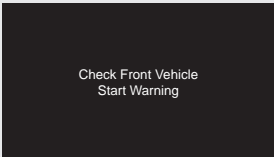
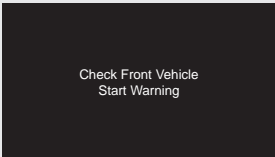



Item	Advanced type	Standard type	Operating conditions
Rear Cross Traffic Warning (RCTW)	 <p>Rear Cross Traffic Warning</p>	 <p>Rear Cross Traffic Warning</p>	<ul style="list-style-type: none"> This message is displayed when a vehicle or object is approaching rear left and/or rear right side of the vehicle during the operation of RCTW system.
	 <p>Rear Cross Traffic Warning</p>	 <p>Rear Cross Traffic Warning</p>	
	 <p>Rear Cross Traffic Warning</p>	 <p>Rear Cross Traffic Warning</p>	

Item	Advanced type	Standard type	Operating conditions
Rear Cross Traffic Alert Intervention (RCTA)	 <p>Press brake pedal</p>	<p>Press brake pedal</p> 	<ul style="list-style-type: none"> If the risk of collision is detected due to an approaching vehicle during operation of the RCTA system, emergency braking (braking assistance) is performed while the corresponding alarm is displayed.
	 <p>Press brake pedal</p>	<p>Press brake pedal</p> 	
	 <p>Press brake pedal</p>	<p>Press brake pedal</p> 	







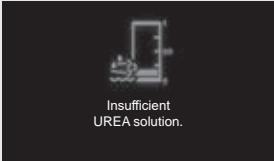
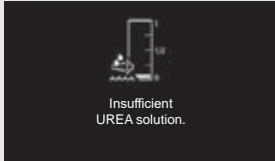
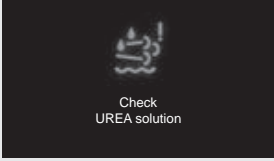
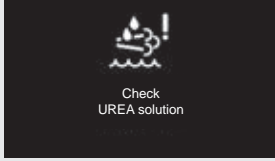

Item	Advanced type	Standard type	Operating conditions
Blind Spot Collision Assist (BSA)	 <p>BSA & RCTA</p>	 <p>BSA & RCTA</p>	<ul style="list-style-type: none"> If the risk of collision is detected due to an approaching vehicle during operation of the BSA system, the steering control is carried out while the corresponding alarm is triggered.
	 <p>BSA & RCTA</p>	 <p>BSA & RCTA</p>	
Front Vehicle Start Warning (FVSW)	 <p>Front Vehicle Start</p>	 <p>Front Vehicle Start</p>	<ul style="list-style-type: none"> This function is enabled when you tick the box at Driving assistance > Front vehicle start alarm under  (User Settings) in the instrument cluster.
	 <p>Check Front Vehicle Start Warning</p>	 <p>Check Front Vehicle Start Warning</p>	<ul style="list-style-type: none"> If there is a fault in the FVSW system, this message is displayed. If the message stays on, have the system checked and serviced at a nearest KG Mobility Authorized Service Center.







Front Vehicle Start Warning (FVSW)





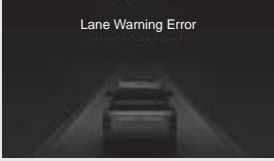
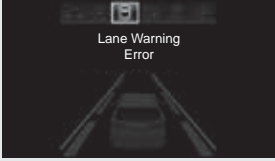

A function to emit a buzzer and display a message if the driver does not depart the vehicle after the front vehicle has departed and moved a certain distance

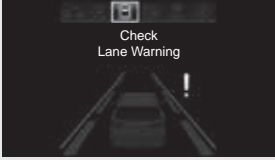







Item	Advanced type	Standard type	Operating conditions
Exhaust Gas Aftertreatment System Operation Request	 <p data-bbox="349 303 488 353">Driving is required to clean Diesel Particulate Filter (DPF)</p>	 <p data-bbox="652 291 792 342">Driving is required to clean Diesel Particulate Filter (DPF)</p>	<ul data-bbox="894 251 1500 326" style="list-style-type: none"> • This message is displayed when the exhaust aftertreatment system is deposited with soot and etc. and the aftertreatment system must be operated.
Warning due to Clogged Exhaust Gas Aftertreatment System	 <p data-bbox="349 495 488 530">Check Diesel Particulate Filter (DPF)</p>	 <p data-bbox="652 483 792 518">Check Diesel Particulate Filter (DPF)</p>	<ul data-bbox="894 451 1500 503" style="list-style-type: none"> • This message is displayed in the event of the faulty exhaust gas aftertreatment system.
Urea System Check Progress Message	 <p data-bbox="349 683 488 718">UREA solution will be checked for 50 km</p>	 <p data-bbox="652 671 792 706">UREA solution will be checked for 50 km</p>	<ul data-bbox="894 616 1500 718" style="list-style-type: none"> • In the normal (warning message disappeared) state after an alert has been issued due to an urea system failure, a message indicating Urea system needs to be checked is displayed for approximately 50 km of driving.
Warning that diagnosis result shows urea system unavailable	 <p data-bbox="349 867 488 930">Unable to restart engine as UREA solution diagnosis is faulty</p>	 <p data-bbox="652 859 792 921">Unable to restart engine as UREA solution diagnosis is faulty</p>	<ul data-bbox="894 816 1500 894" style="list-style-type: none"> • If the urea system is still faulty after checking the urea system while driving the vehicle for 50 km, a corresponding warning message is displayed and the engine restart is not possible.







Item	Advanced type	Standard type	Operating conditions
Warning due to low urea level	 <p>Insufficient UREA solution.</p>	 <p>Insufficient UREA solution.</p>	<ul style="list-style-type: none"> • If the urea system is faulty, a warning message is displayed divided into 6 areas. • Each warning is divided into 3 Tiers according to its severity. At 3 Tier, it is impossible to operate the vehicle. • If the warning lamp turns on or a warning message appears, have the vehicle checked at a KG Mobility Dealer or KG Mobility Authorized Service Center. <p>☞ Refer to “Exhaust gas after-treatment system II (SCR)” (p.6-63)</p>
Warning due to urea system (DCU and electrical fault)	 <p>Check UREA solution</p>	 <p>Check UREA solution</p>	





Item	Advanced type	Standard type	Operating conditions
Warnings due to urea injection system	 <p data-bbox="354 306 483 338">Check UREA solution injection device</p>	 <p data-bbox="656 301 786 332">Check UREA solution injection device</p>	<ul data-bbox="894 459 1500 656" style="list-style-type: none"> • If the urea system is faulty, a warning message is displayed divided into 6 areas. • Each warning is divided into 3 Tiers according to its severity. At 3 Tier, it is impossible to operate the vehicle. • If the warning lamp turns on or a warning message appears, have the vehicle checked at a KG Mobility Dealer or KG Mobility Authorized Service Center. <p data-bbox="886 663 1419 683">☞ Refer to “Exhaust gas after-treatment system II (SCR)” (p.6-63)</p>
Warning due to incorrect reagent	 <p data-bbox="370 495 466 526">UREA solution is inappropriate</p>	 <p data-bbox="672 489 768 520">UREA solution is inappropriate</p>	
Low SCR Catalyst Purification Efficiency	 <p data-bbox="375 686 461 718">SCR catalyst low efficiency</p>	 <p data-bbox="678 680 764 712">SCR catalyst low efficiency</p>	
Warning due to abnormal exhaust emissions	 <p data-bbox="354 874 483 906">Emission too high - Check UREA solution</p>	 <p data-bbox="656 863 786 894">Emission too high - Check UREA solution</p>	

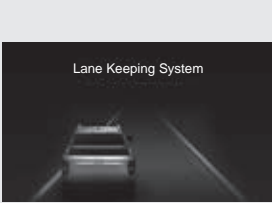
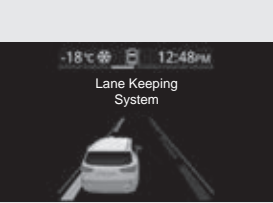

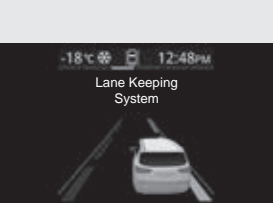

Item	Advanced type	Standard type	Operating conditions
Lane Departure Warning (LDW)			<ul style="list-style-type: none"> • Displayed when the lane departure warning is disabled.
			<ul style="list-style-type: none"> • The lanes are shaded when the vehicle is driven at a low speed of less than 40km/h or at a high speed of 180 km/h or higher or both lanes are not detected.
			<ul style="list-style-type: none"> • Displayed when the lane departure warning is disabled.
			<ul style="list-style-type: none"> • This message is always displayed in the event of the faulty LDW. • Displayed as pop-up message 3 seconds after the start-up when there is a fault in the lane departure warning. • If the message stays on, have the system checked and serviced at a nearest KG Mobility Authorized Service Center.

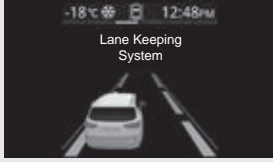

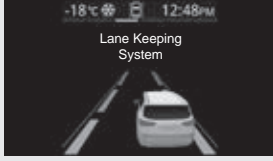
Item	Advanced type	Standard type	Operating conditions
LDW Lane Display Area			<ul style="list-style-type: none"> • Even though the left lane is detected only, the detected left lane will be displayed. (Advanced type: green, Standard type: white) • If the driver does not operate the turn signal or turn on the right turn signal and approach the left lane, the lane will blink. (Advanced type: green ↔ red, Standard type: shaded white)
			<ul style="list-style-type: none"> • If only right lane is detected, the detected right lane will be displayed in green. (Advanced type: green, Standard type: white) • If the driver does not operate the turn signal or turn on the left turn signal and approach the left lane, the lane will blink. (Advanced type: green ↔ red, Standard type: shaded white)
			<ul style="list-style-type: none"> • If both lanes are detected, the detected both lanes will be displayed. (Advanced type: green, Standard type: white)

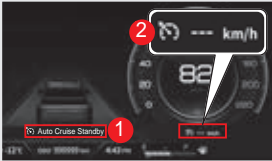
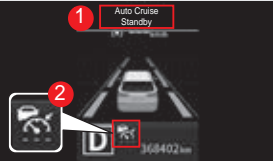

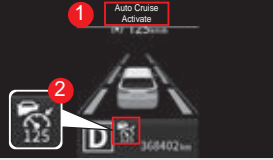
Item	Advanced type	Standard type	Operating conditions
LDW Lane Display Area			<ul style="list-style-type: none"> If both lanes are detected and the vehicle approaches the left or right lane without turning on the turn signal, the lane will blink. (Advanced type: green ↔ red, Standard type: shaded white)
			
LKA (Lane Keeping Assistance)			<ul style="list-style-type: none"> Displayed when the lane keeping assistance system is disabled.
			<ul style="list-style-type: none"> The lanes are shaded when the vehicle is driven at a low speed of less than 40km/h or at a high speed of 180 km/h or higher or both lanes are not detected.

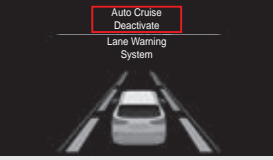

Item	Advanced type	Standard type	Operating conditions
Lane Keeping Assistance (LKA)	 <p>Lane Keeping Error</p>	 <p>Lane Keeping Error</p>	<ul style="list-style-type: none"> • Displayed when the lane keeping assistance system is disabled.
	 <p>Check Lane Keeping</p>	 <p>Check Lane Keeping</p>	<ul style="list-style-type: none"> • Displayed as pop-up message 3 seconds after the start-up when there is a fault in the lane keeping assistance system. • If the message stays on, have the system checked and serviced at a nearest KG Mobility Authorized Service Center.
LKA Lane Display Area	 <p>Lane Keeping System</p>	 <p>Lane Keeping System</p>	<ul style="list-style-type: none"> • Even though the left lane is detected only, the detected left lane will be displayed. (Advanced type: green, Standard type: white)(Pop-up messages will not be displayed.) • If the driver does not operate the turn signal or turn on the right turn signal and approach the left lane, the lane will blink. (Advanced type: green ↔ red, Standard type: shaded white)(Pop-up message displayed)
	 <p>Lane Keeping System</p>	 <p>Lane Keeping System</p>	<ul style="list-style-type: none"> • Even though the right lane is detected only, the detected right lane will be displayed. (Advanced type: green, Standard type: white)(Pop-up messages will not be displayed.) • If the driver does not operate the turn signal or turn on the left turn signal and approach the right lane, the lane will blink. (Advanced type: green ↔ red, Standard type: shaded white)(Pop-up message displayed)

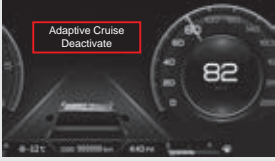

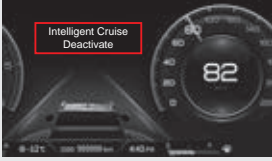

Item	Advanced type	Standard type	Operating conditions
LKA lane display area			<ul style="list-style-type: none"> If both lanes are detected, the detected both lanes will be displayed. (Advanced type: green, Standard type: white)
			<ul style="list-style-type: none"> If both lanes are detected and the vehicle approaches the left or right lane without turning on the turn signal, the lane will blink. (Advanced type: green ↔ red, Standard type: shaded white)(Pop-up message displayed)
			





Item	Advanced type	Standard type	Operating conditions
Cruise Control (Without Radar)			<ul style="list-style-type: none"> When you press the cruise control ON/OFF switch with the ignition switch turned on, "Auto cruise ready" message (1) and symbol (2) are displayed and the auto cruise becomes ready.
			<ul style="list-style-type: none"> When you pull down the speed control lever with the auto cruise ready, "Auto cruise set" message (1), symbol and set speed (2) are ready and auto cruise is activated. Adjust the vehicle speed by pushing up or pulling down the speed control lever.
			<ul style="list-style-type: none"> If you disable the cruise control during its operation (ready / auto), "Auto cruise disabled" message is displayed and the cruise control is deactivated.









Item	Advanced type	Standard type	Operating conditions
Adaptive Cruise Control (ACC) (With Radar)		-	<ul style="list-style-type: none"> During the adaptive cruise control (ACC) operation, when the standby conditions such as the brake pedal are satisfied, the message "Adaptive Cruise Control Ready" (1) and symbol (2) are displayed, and the adaptive cruise control (ACC) enters standby mode. While the adaptive cruise control (ACC) is in standby mode, pushing up the cruise control speed adjustment lever in the RES+ direction activates the adaptive cruise control (ACC).
		-	<ul style="list-style-type: none"> When you pull down the speed control lever with the adaptive cruise ready, "Adaptive cruise set" message (1), symbol and set speed (2) are ready and adaptive cruise is activated. If there is no vehicle ahead, the driver's vehicle keeps driving at the set speed. If there is a vehicle driving at a speed lower than the set speed ahead, the driver's vehicle will travel while maintaining a set distance to the vehicle ahead.
		-	<ul style="list-style-type: none"> If you disable the adaptive cruise control during its operation (ready/ auto), "Adaptive cruise disabled" message is displayed and the adaptive cruise control is deactivated.





Item	Advanced type	Standard type	Operating conditions
Intelligent Cruise Control (iACC) (With Radar)		-	<ul style="list-style-type: none"> • During the intelligent cruise control (IACC) operation, when the standby conditions such as the brake pedal are satisfied, the message "Intelligent Cruise Control Ready" (1) and symbol (2) are displayed, and the intelligent cruise control (IACC) enters standby mode. • While the intelligent cruise control (IACC) is in standby mode, pushing up the cruise control speed adjustment lever in the RES+ direction activates the intelligent cruise control (IACC).
		-	<ul style="list-style-type: none"> • When you pull down the speed control lever with the intelligent cruise ready, "Intelligent cruise set" message (1), symbol and set speed (2) are displayed and intelligent cruise is activated. • If there is no vehicle ahead, the driver's vehicle keeps driving at the set speed. • If there is a vehicle driving at a speed lower than the set speed ahead, the driver's vehicle will travel while maintaining a set distance to the vehicle ahead.
		-	<ul style="list-style-type: none"> • If you disable the intelligent cruise control during its operation (ready/ auto), "Intelligent cruise disabled" message is displayed and the intelligent cruise control is deactivated.





Item	Advanced type	Standard type	Operating conditions
Intelligent steering assist control		-	<ul style="list-style-type: none"> • The steering assist symbol is displayed in 3 steps (Ready to set, Set, and Activated) depending on the operating state of the intelligent cruise control. <ul style="list-style-type: none"> - Step 1 (1) : When the intelligent cruise control is in ready mode in the driver assistance main menu - Step 2 (2) : When the intelligent cruise control is set - Step 3 (3) : When driving while maintaining the center of the lane with the intelligent cruise control set
		-	
		-	

Item	Advanced type	Standard type	Operating conditions
Intelligent cruise control's distance display (front vehicle not displayed)	<p>Level 1</p> 		<ul style="list-style-type: none"> • When you press the safety distance set button with the intelligent cruise control activated, the corresponding message is displayed while the setting is shifted by one step as an order of step 5 → step 4 → step 3 → step 2 → step 1 → step 5. • This is also the same as when intelligent cruise control is in operation, and a circular symbol appears on the driver's vehicle.
	<p>Level 2</p> 		
	<p>Level 3</p> 		
	<p>Level 4</p> 		
	<p>Level 5</p> 		



Item	Advanced type	Standard type	Operating conditions
Intelligent cruise control's distance display (front vehicle displayed)	Level 1 		<ul style="list-style-type: none"> When you press the safety distance set button with the intelligent cruise control activated, the corresponding message is displayed while the setting is shifted by one step as an order of step 5 → step 4 → step 3 → step 2 → step 1 → step 5. At this time, the front vehicle is also displayed on the message. This is also the same as when intelligent cruise control is in operation, and a circular symbol appears on the driver's vehicle.
	Level 2 		
	Level 3 		
	Level 4 		
	Level 5 		

Item	Advanced type	Standard type	Operating conditions
Emergency Lane Keeping (ELK)	 <p>Keep hands on steering wheel</p>	 <p>Keep hands on steering wheel</p>	<ul style="list-style-type: none"> If the system determines that the driver does not hold the steering wheel with the lane keeping assistance system activated, a message is displayed as the stage 1 warning.
	 <p>Keep hands on steering wheel</p>	 <p>Keep hands on steering wheel</p>	<ul style="list-style-type: none"> When a certain period of time has elapsed after the stage 1 warning, the message and beep are given as the stage 2 warning.
	 <p>Keep hands on steering wheel</p>	 <p>Keep hands on steering wheel</p>	<ul style="list-style-type: none"> After the stage 2 warning, for safe operation, the intelligent cruise control system is disabled and the relevant message is displayed.
	 <p>Lane Keeping Assist (LKA) has been deactivated</p>	 <p>Lane Keeping Assist (LKA) has been deactivated</p>	<ul style="list-style-type: none"> After the stage 3 warning, for safe operation, the LKAS is disabled and the relevant message is displayed.

Item	Advanced type	Standard type	Operating conditions
Intelligent cruise control hands-off	 <p>Keep hands on steering wheel</p>	-	<ul style="list-style-type: none"> If the system determines that the driver does not hold the steering wheel with the intelligent cruise control system activated, a message is displayed as the stage 1 warning.
	 <p>Keep hands on steering wheel</p>	-	<ul style="list-style-type: none"> When a certain period of time has elapsed after the stage 1 warning, the message and beep are given as the stage 2 warning.
	 <p>Intelligent Adaptive Cruise Control (IACC) has been deactivated</p>	-	<ul style="list-style-type: none"> After the stage 2 warning, for safe operation, the intelligent cruise control system is disabled and the relevant message is displayed.
	 <p>Intelligent Adaptive Cruise Control (IACC) is deactivated temporarily</p>	-	<ul style="list-style-type: none"> After the stage 3 warning, for safe operation, the intelligent cruise control system is temporarily disabled and the relevant message is displayed.

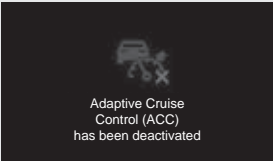
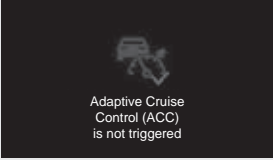
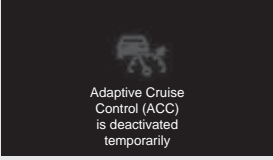
Item	Advanced type	Standard type	Operating conditions
Adaptive Cruise Control Alert Pop-up	 <p>Forward Collision Warning</p>	-	<ul style="list-style-type: none"> When the front vehicle is no longer detected for example, due to change of lane, during the adaptive cruise control operation, the message is displayed.
	 <p>When front vehicle departs, operate RES, SET button or pedal</p>	-	<ul style="list-style-type: none"> If the vehicle stops during the adaptive cruise control operation (or along with ISG), after a certain period of time, you will be prompted to step on the accelerator pedal or raise or lower the cruise control switch to start.
	 <p>Front Vehicle Approach Warning</p>	-	<ul style="list-style-type: none"> The message is displayed when the distance between the driver's vehicle and the preceding vehicle is getting smaller with the adaptive cruise control activated.
	 <p>Driver Accelerating</p>	-	<ul style="list-style-type: none"> The message is displayed when the driver depresses the accelerator pedal with the adaptive cruise control activated.

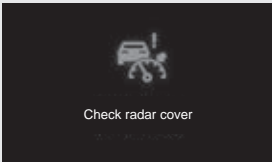
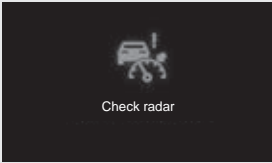
Item	Advanced type	Standard type	Operating conditions
Adaptive Cruise Control Alert Pop-up	 <p>Adaptive Cruise Control (ACC) has been deactivated</p>	-	<ul style="list-style-type: none"> The message is displayed when the adaptive cruise control is automatically deactivated.
	 <p>Adaptive Cruise Control (ACC) is not triggered</p>	-	<ul style="list-style-type: none"> The message is displayed If the operation conditions do not meet during the adaptive cruise control operation.
	 <p>Adaptive Cruise Control (ACC) is deactivated temporarily</p>	-	<ul style="list-style-type: none"> The message is displayed If the operation conditions do not meet during the adaptive cruise control operation.

Item	Advanced type	Standard type	Operating conditions
Adaptive Cruise Control Check Pop-up	 <p>Check radar cover</p>	-	<ul style="list-style-type: none"> A message is displayed when the front part of the camera cover is contaminated due to dust, dirt or other materials and can't detect the lane, preceding vehicle or people, etc.
	 <p>Check radar</p>	-	<ul style="list-style-type: none"> This message is displayed in the event of the faulty radar system. If the message stays on, have the system checked and serviced at a nearest KG Mobility Authorized Service Center.
Safety distance alert	 <p>Keeping Safe Distance</p>	-	<ul style="list-style-type: none"> This function is enabled when you tick the box at Driving assistance → Safety distance alert under (User Settings) in the instrument cluster. The message is displayed when your vehicle is approaching the preceding vehicle.
	 <p>Check Safety Distance Warning (SDW)</p>	-	<ul style="list-style-type: none"> The message is displayed if the safety distance reminder system is faulty. If the message stays on, have the system checked and serviced at a nearest KG Mobility Authorized Service Center.

SDA (Safety Distance Alert)

Function to display the message to the driver when it is determined that safety distance is not secured by analyzing the information such as distance to front vehicle, speed and position

Shift lever in manual transmission

The manual transmission in your vehicle has 6 forward gears and 1 reverse gear. To change gears, fully depress the clutch pedal. Then, move the gearshift lever into a desired gear. After shifting, release the clutch slowly.



Neutral Position

Position for engine start, vehicle stop, and parking

- ① Reverse Gear
- ② 1st Gear
- ③ 3rd Gear
- ④ 5th Gear
- ⑤ 6th Gear
- ⑥ 4th Gear
- ⑦ 2nd Gear

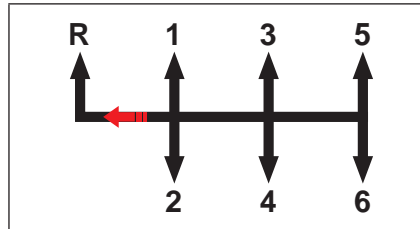

Reverse Gear

Position for reverse driving.

Shifting to R (Reverse)

To ensure safety in reverse shift, it is designed to be shifted to the reverse gear by applying greater operating force than forward shift (with high-force type). This allows the driver to recognize the reverse shift, which helps to avoid shift operation error. The reverse gear is placed on the left side of the 1st gear. When the vehicle is completely stopped, put the shift lever to the reverse (R) position by pulling it to the left harder than when shifting to the 1st gear and pushing forward.

! Caution

- If the driver tries to shift to the 1st gear quickly, due to characteristics of the reverse shift method, a momentary strong power may result in engagement of the reverse gear in place of the 1st gear.
- When starting the vehicle, fully familiarize yourself with the positions of the 1st gear and the reverse gear.
- Before starting the vehicle, depress the brake pedal and move the shift lever to the R position. Then, check that the reverse gear indicator lights up on the instrument cluster and listen for a beep. Otherwise, have your vehicle checked and serviced at KG Mobility dealer.

1st Gear

Position for driving off and high traction force. Depress the clutch pedal to its travel end and move the shift lever to "1". Then, slowly release the clutch pedal while gently depressing the accelerator pedal to drive off.

3rd Gear

For low- or mid-speed driving. When upshifting from 2nd gear to 3rd gear, particular caution should be taken not to inadvertently press the gear shift lever sideways in such a manner that 5th gear is engaged.

5th Gear

Position for high speed driving on a highway. When downshifting from 5th gear to 4th gear, particular caution should be taken not to inadvertently press the gear shift lever sideways in such a manner that 2nd gear is engaged.

6th Gear

Position for very high speed driving on a highway.

4th Gear

Position for normal and high speed driving

2nd Gear

Position for low speed driving

Notice

- Your vehicle is equipped with the gear shift point indicator, which can be shown on LCD display. Refer to Chapter 5. Instrument cluster for details.

Downshifting

When you need to slow down in heavy traffic or while driving up steep hills, downshift the gear to release the load to the engine. Downshifting reduces the chance of stalling and gives better acceleration when you need to increase the vehicle speed again. When the vehicle is driving down steep hills, downshifting provides a safe speed and prolongs the life span of brake system.

Gear position when parking

Always apply the parking brake fully and shut the engine off after parking. Shift the transmission into 1st gear when the vehicle is parked on a level ground or uphill grade, and shift into "R" on a downhill grade.

Using the clutch

The clutch pedal should be depressed all the way to its travel end before shifting. The clutch pedal should be fully released while driving. Do not rest your foot on the clutch pedal while driving. This can cause unnecessary wear in clutch system. Do not operate the clutch pedal rapidly and repeatedly.

Driving tips for normal starting off or starting off on uphill

- 1 Depress the clutch pedal and the brake pedal, start the engine and move the shift lever to the 1st gear (reverse gear in reversing) position.
- 2 If the clutch pedal is released slightly with the brake pedal depressed, the engine rpm increases. (The increase in engine rpm varies depending on the road inclination).

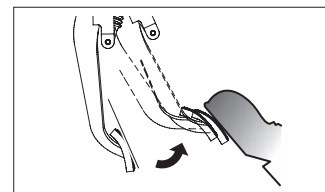

Release the clutch pedal slightly

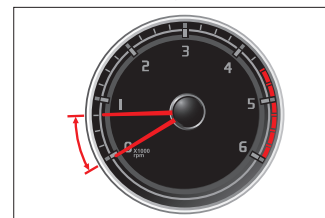

Increase in engine rpm

- 3 The vehicle starts to move smoothly if you depress the accelerator pedal while releasing the brake pedal after checking that the engine rpm is raising.
- 4 Release the clutch pedal completely after the vehicle starts off.

Notice

- The vehicles equipped with ESP system has HSA (Hill Start Assist) function, which keeps the brake pressure for a certain period of time to prevent the vehicle from slipping on a steep uphill when starting the engine so that you can move your vehicle more safely. HSA system is automatically deactivated after operating for approx. 3 seconds, or the vehicle starts moving with accelerator pedal depressed.
- HSA function does not work when you start the vehicle parked on an uphill in reverse gear, or when you start the vehicle parked on downhill in drive gear.



Caution

- Because the HSA operation on the brake is automatically cancelled after approx. 3 seconds, you have to release the brake pedal intentionally and depress the accelerator pedal so the vehicle does not slip down the hill.

Parking Brake Operation When Driving Uphill

When driving on a steep uphill, it is safer to use the parking brake as follows: Apply the parking brake, follow steps (Vehicle with M/T: steps 1 - 3, and release the parking brake when the vehicle starts to move.



Caution

- To start the engine in manual transmission equipped vehicle, you must fully depress the clutch pedal.
- You should stop your vehicle and fully depress the clutch pedal before you shift into the reverse position.
- If the clutch pedal is frequently half-depressed, the clutch disc will be easily worn out. Use only as needed.
- Do not put your foot on the clutch pedal if not shifting gears.
- When shifting from a higher gear into a lower gear, ensure that the RPM gauge pointer does not go into the red zone on the gauge. Especially, when shifting from the 5th to the 4th gear, moving the gear shift lever to the left too much may result in shifting into the 2nd gear. This will cause a sudden increase of the engine speed and may damage the engine and the transmission.

- When the temperature of the transmission oil is very low on a cold day, you may have some difficulty for shifting gears. This is a normal phenomenon.
- When you have difficulty for shifting into the 1st or reserve gear, put the gear shift lever into the neutral position and release the clutch pedal. Then, depress the pedal again and shift into the intended gear.
- While your vehicle is moving, do not put your hand on the shift lever except to shift gears. Otherwise, the gear may be disengaged from the transmission and the internal transmission components may be damaged.
- Do not shift into the second next higher gear from a lower gear. Also, while the engine is rotating fast, do not shift into a lower gear.
- When using the half clutch mode, there is no need to abruptly depress the accelerator pedal because the engine power increases. When the accelerator pedal is continuously depressed in half clutch mode, the internal components can be worn or damaged. Frequent use of half clutch mode is not recommended.

Gear selector lever in automatic transmission*

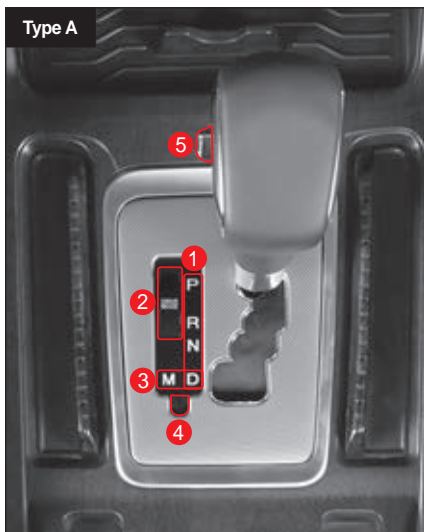

- 1 Gear position
- 2 Mode switch
- 3 Selection of manual/Automatic shift function
- 4 P, N position unlock button
- 5 Manual gear shift lever

Gear position

- P: Parking
- R: Reverse
- N: Neutral
- D: Driving

Mode switch

Type A

- N : Normal mode
- S : Sport mode
- W : Winter mode

Use the standard mode in normal driving conditions.

Type B

- E : Eco mode
- P : Power mode
- W : Winter mode

Use the Eco mode in normal driving conditions.

Selection of manual/automatic shift function

- D: Automatic shift according to the driving condition
- M: Manual shift

P, N position unlock button

When the gear shift lever is locked in the P (parking) or the N (neutral) position, move the gear shift lever with the Unlock button pressed with the emergency key.

At this time, turn off the engine and move the gear shift lever with the brake pedal depressed.

Manual gear shift lever

You can shift the gear by pushing or pulling the manual gear shift lever after moving the gear shift lever from the D (driving) position to the M (manual) position.

P (parking) position



Select this position for parking the vehicle, starting or warming up the engine, or stopping the vehicle for a long period of time.

Warning

- Be sure to move the gear shift lever from the P (parking) position to another position while depressing the brake pedal with the START/STOP switch in the ON status. Do not apply excessive force to the gear shift lever when it is fixed to the P (parking) position. Doing so may damage the lever and the transmission.
- Never move the gear shift lever to the P (parking) position while driving. Doing so may cause mechanical damage and an accident. Be sure to move the gear shift lever to the P (parking) position after stopping the vehicle completely.
- Do not use the P (parking) position instead of the parking brake. Apply the parking brake while parking or stopping.

R (reverse) position

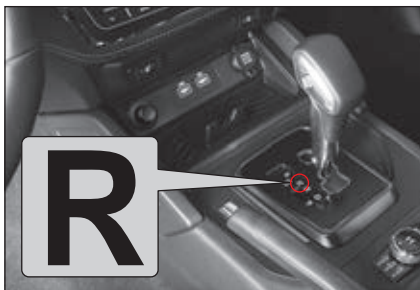

Select this position for reversing the vehicle.

Be sure to move the gear shift lever from the P (parking) or N (neutral) to the R (reverse) position with the brake pedal depressed after stopping the vehicle completely.

When you place the gear shift lever in the R (reverse) position, the PAS is activated.

Warning

- Do not place the gear shift lever in the R position while the vehicle is moving forward. Doing so may cause a transmission shock and damage the transmission.
- If the gear shift lever is placed in the R (reverse) position, the vehicle moves back slowly even if the accelerator pedal is not depressed. Drive carefully by depressing the brake pedal.

N (neutral) position



In this position, no power is transferred.

Since the engine power is not transferred to the wheels in the N (neutral) position, so the vehicle does not move on a flat road. However, if you stop the vehicle with the gear shift lever placed in the N (neutral) position, be sure to depress the brake pedal for safety.

Warning

- Do not apply excessive force to the gear shift lever when it is fixed to the N (neutral) position. Doing so may damage the lever and the transmission.
- Do not move the gear shift lever from the D (driving) position to the N (neutral) position or from the N (neutral) position to the D (driving) position while the vehicle is moving.
- To stop the vehicle with the gear shift lever in the N (neutral) position on a sloping road, be sure to depress the brake pedal.
- Never place the gear shift lever in the N (neutral) position while driving. Doing so may cause the engine brake not to operate, resulting in an accident.

D (driving) position

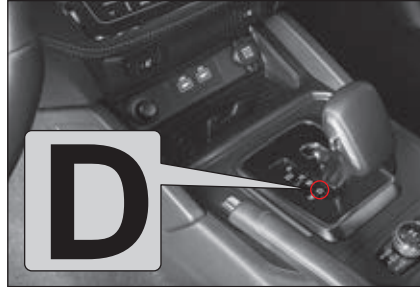

Select this position for driving on a normal road or an expressway.

The gear (1st ~ 6th) is shifted automatically according to the vehicle speed and the depression degree of the accelerator pedal.

Warning

- When the gear shift lever is placed in the D (driving) position, the vehicle moves forward slowly even if the accelerator pedal is not depressed, so drive the vehicle carefully.
- Move the gear shift lever to the D (driving) position after the vehicle has stopped completely. Failure to do so may damage the transmission.
- You can move the gear shift lever from the N (neutral) position to the D (driving) position without depressing the brake pedal. However, move the gear shift lever with the brake pedal depressed for safety.
- Do not drive or accelerate the vehicle suddenly after moving the gear shift lever to the D (driving) position. In particular, when you drive the vehicle after stopping or parking the vehicle on a sloping road, move the gear shift lever to the D (driving) position with the brake pedal depressed, wait for a couple of seconds until the power is transferred in the transmission and drive the vehicle slowly.
- Even if the gear shift lever is placed in the D (driving) position, the vehicle may roll down on a sloping road, so be sure to depress the brake pedal.

M (manual) position

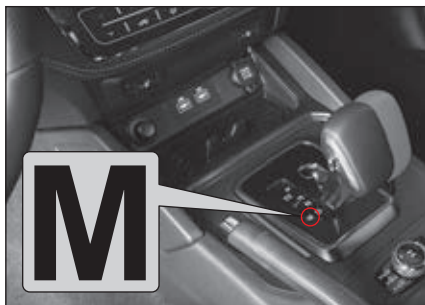

You can shift the gear manually (1st–6th) just as a manual transmission by moving the gear shift lever from the D (driving) position to the M (manual) position.

Warning

- Be careful not to move the gear shift lever to the M (manual) position carelessly while driving. Failure to do so shifts the gear, making the driving status of the vehicle unstable and resulting in an accident. Pay particular attention when driving during winter.

Caution

- Upshifting should be carried out properly in accordance with the road and driving conditions. Be careful not for the engine RPM to fall within the red zone in the tachometer.

Shifting

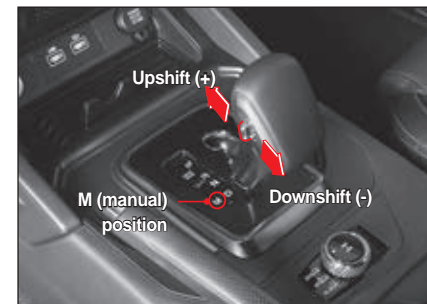

You can shift the gear by pushing or pulling the manual gear shift lever from the M (manual) position.

Notice

- When you move the gear shift lever to the M (manual) position while stopping, you can downshift the gear, and you can start driving the vehicle at the 2nd gear position on a snowy road or a wet road. (WINTER mode function)
- Sometimes, the gear cannot be shifted when you operate + (upshift) according to the vehicle speed for securing the driving performance. Also, the gear may not be shifted for preventing excessive engine RPM even if you downshift according to the vehicle speed.

Display of gear shift lever position on the instrument cluster

Supervision type



Standard type



Warning

- Do not downshift (3rd, 2nd, 1st) suddenly while driving the vehicle at a high speed. Doing so may damage the vehicle significantly. The vehicle also may slip, resulting in an accident. (especially when driving on a slippery road)

Caution

- Operate the manual gear shift lever once at a time. If you press and hold down the lever, the gear may be shifted to a number of gear positions consecutively.
- Please note that the gear may be upshifted if you fully depress the accelerator pedal while driving with 1st, 2nd, 3rd, and 4th gear.
- If you downshift excessively by operating the manual gear shift lever, the gear may not be shifted for protecting the vehicle system.
- Do not speed up forcibly with the gear shift lever in a lower gear position. Doing so may damage the automatic transmission.

Using the engine brake

To use the engine brake, downshift the gear by one gear position at a time using the manual gear shift lever from the M (manual) position.

Warning

- Avoid using the engine brake suddenly. Doing so may lead to unstable driving. In particular, avoid using the engine brake suddenly while driving on a snowy road or an icy road.

Caution

- Operate the manual gear shift lever once at a time. If you press and hold down the lever, the gear may be shifted to a number of gear positions consecutively.
- When using the engine brake, the gear may be shifted differently depending on the driving condition of the vehicle and you may feel a strong shifting shock.

If the gear shift lever cannot be moved from the P (parking) position to another position

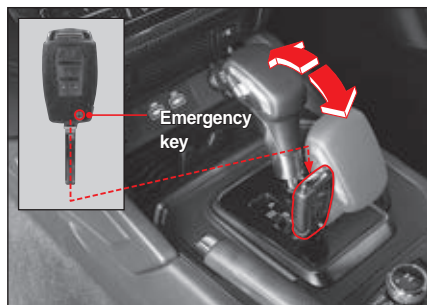

If the gear shift lever cannot be moved from the P (parking) to another position even if the START/STOP switch is in the ON status and the brake pedal is depressed, move the gear shift lever manually as follows.

- 1 Turn off the engine and apply the parking brake.
- 2 Depress the brake pedal, press the Unlock button using the emergency key and move the gear shift lever to the N (neutral) position.
- 3 In the N (neutral) position, depress the brake pedal and start the engine.
- 4 Move the gear shift lever to the D (driving) position.
- 5 Release the parking brake, take your foot off the brake pedal and drive the vehicle.

Caution

- If the gear shift lever cannot be moved from the P (parking) position to another position, be sure to have your vehicle serviced at a KG Mobility authorized service center.

Driving a vehicle equipped with automatic transmission

Place the gear shift lever in the P (parking) position and start the engine with the brake pedal depressed.

- 1 Ensure that the engine RPM is in normal range and place the gear shift lever in the D (driving) or the R (reverse) position with the brake pedal depressed.
- 2 Release the parking brake, take your foot off the brake pedal and drive the vehicle slowly.



Warning

- Do not depress the accelerator pedal when starting the engine. Doing so may make the vehicle move suddenly, causing an accident.
- The engine can also be started after the gear shift lever is placed in the N (neutral) position. However, start the engine after placing it in the P (parking) position for safety.
- Do not drive or accelerate the vehicle suddenly after moving the gear shift lever from the P (parking) position to the D (driving) or the R (reverse) position. In particular, when you drive the vehicle after stopping on a hillside road, move the gear shift lever to the D (driving) or R (reverse) position with the brake pedal depressed, wait a number of seconds until the power is transferred in the transmission and drive the vehicle slowly.

- Caution should be taken that the vehicle may roll down when it is parked on a sloping road even if the gear shift lever is placed in the D (driving) or the R (reverse) position.
- When moving the gear shift lever while stopping the vehicle, be sure to depress the brake pedal for safety.
- Never depress the accelerator pedal when moving the gear shift lever.
- Be sure to apply the parking brake and depress the brake pedal when stopping on a sloping road.
- On a steep uphill road or downhill road, the vehicle may move in the opposite direction of its moving direction even if the creep phenomenon occurs. Be sure to depress the brake pedal when stopping on an uphill road or a downhill road.
- Do not move the gear shift lever to the N (neutral) position while driving. Doing so may cause the engine brake to not be applied, resulting in an accident. The devices inside the transmission also may not be lubricated smoothly, damaging the transmission.

Notice

- Take your foot off the brake pedal and drive the vehicle slowly by depressing the accelerator pedal after checking that the vehicle moves slowly (creep phenomenon).
- Moving the gear shift lever with the force applied to the driving system of the vehicle due to a slope such as parking or stopping on a hillside road may cause a shock and a noise. This is a mechanical phenomenon that occurs in the P position of the automatic transmission and it is not a system failure.
- In order to maintain the engine in its optimal status, the engine control unit learns and memorizes the inspection characteristics of the injector in accordance with various factors of the engine. Slight vibrations and noises may occur within a short period of time when idling in such a process. This is normal operation of the engine system. Do not misunderstand it as a failure.

What is the creep phenomenon?

The creep phenomenon is the phenomenon that the vehicle moves slowly without the accelerator pedal depressed if the gear shift lever is placed in the D (driving) or the R (reverse) position while the engine is running.

You can move the vehicle or adjust the speed by simply operating the brake pedal in heavy traffic or when driving the vehicle slowly in a narrow area.

What is automatic shift point?

The automatic shift point of the automatic transmission may vary depending on various driving elements including the road condition (flat ground, hillside road), position of gear shift lever, vehicle speed and depression degree of accelerator pedal. This is a normal operation for securing smooth and stable shifting, proper economy and vehicle performance.

Using the engine brake

When driving a long downhill road, use the engine brake and the foot brake at the same time. When you downshift according to the driving condition, the engine brake will operate.

What is the engine brake?

The engine brake is the decelerating force that occurs due to the deceleration of the engine when you take your foot off from the accelerator pedal while driving. Down shifting while driving a downhill road can receive the braking effect without using the foot brake frequently due to the decelerating force that occurs in the engine. The lower the gear, the higher the engine brake effect.

Warning

- **Do not use the foot brake excessively on a downhill road. Doing so may cause the fade or vapor lock phenomenon due to overheating of the brake system, lowering the braking performance.**
- **The engine brake does not operate when the gear shift lever is placed in the N (neutral) position.**
- **Do not apply the engine brake suddenly. Doing so may cause the tires to slip, resulting in an accident.**

Using the kick down function

You can use the kick down function by depressing the accelerator pedal to the end when you need instantaneous accelerating force for passing a vehicle.

What is the kick down function?

The kick down function downshifts the gear by one or two lower gear positions when the accelerator pedal is depressed to the end while driving. It can be used when instantaneous accelerating force is necessary.



Warning

- **Do not use the kick down function on a slippery road or a sharply curved road. If the tires slip, an unexpected accident may occur.**
- **Using the kick down function excessively may adversely affect the durability and fuel economy of the vehicle.**

Safety mode of the automatic transmission

When an electrical or mechanical defect occurs in the automatic transmission, the automatic transmission enters the safety mode in order to prevent the transmission from being damaged while maintaining the minimum driving status.

When the automatic transmission enters the safety mode, any of the following symptoms may occur.

- A significant shock occurs when moving the gear shift lever.
- The driving force is reduced while driving the vehicle at a high speed.
- When the gear shift lever is fixed to the driving position (D, R) and the vehicle speed does not increase even if the accelerator pedal is depressed (the speed is fixed to the medium speed).



Caution

- **If the safety mode symptom appears due to an electrical or a mechanical defect of the automatic transmission, do not drive the vehicle and have your vehicle checked and serviced at a nearby KG Mobility authorized service center.**

Resetting the safety mode when the gear shift lever is fixed to a position

Resetting the safety mode

- 1 Stop the vehicle and -place the gear shift lever in the P (parking) position.
- 2 Turn off the engine and wait for 10 seconds or longer.
- 3 Start the engine.

After resetting the safety mode, you can drive the vehicle normally.

If the fixed gear shift lever phenomenon appears after resetting the safety mode

The following fixed gear shift lever symptom appear after resetting the safety mode.

- The gear shift lever is fixed to the D (driving) position
- The gear shift lever is fixed to the R (reverse) position

In such case, have your vehicle checked and serviced at a nearby KG Mobility authorized service center.



Caution

- **If the safety mode symptom persists after resetting the safety mode, do not drive the vehicle forcibly and have your vehicle checked and serviced at a KG Mobility authorized service center immediately.**

Cautions for using a vehicle equipped with automatic transmission



Warning

- Never move the gear shift lever to the P (parking) or the N (neutral) position while driving. Doing so may cause mechanical damage and an accident.
- Starting the vehicle is available when the gear shift lever is placed in the P (parking) or the N (neutral) position. Start the engine with the gear shift lever in the P (parking) position for safety.
- Do not down shift suddenly while driving the vehicle at a high speed. Doing so may damage the vehicle significantly. Doing so also may lead to unstable driving and result in an accident.



Caution

- Do not place the gear shift lever in the R position while the vehicle is moving forward. Doing so may cause a transmission shock and damage the transmission.
- Do not place the gear shift lever in the N (neutral) position when driving on a downhill road or an uphill road. Placing the gear shift lever back in the D (driving) position for driving after placing it in the N (neutral) position may damage the driving system due to a transmission shock.
- The P lock (P position → R position) and the R lock (N position → R position) functions that allow the operation of the gear shift lever only when the brake pedal is depressed for safe driving.
- When you unlock the gear shift with the brake pedal depressed by the P lock and the R lock functions, there may be a normal operating sound of locking and unlocking the gear shift lever.
- When you move the gear shift lever related to the R lock function from the D (driving) position to the P (parking) position rapidly, there may be intermittent trapping in the N (neutral) position. This is a normal phenomenon for safety and the protection of the transmission. However, avoid sudden operation if possible.

4WD System*

The 4WD system is the system that distributes the power to four wheels properly by distributing the power transferred to the rear wheels through the transfercase to the front wheels.

Using the 4WD system on a slippery road such as a snowy road or a wet road allows you to maintain more stable driving status in comparison to the 2WD (2-Wheel Drive) mode. You can switch the driving mode to 4WD LOW for maximum traction power.

What is the part time transfer case?

The part time transfercase is the system that switches the driving mode to the 4WD HIGH (4H) mode or the 4WD LOW (4L) mode through the switch operation when necessary while the vehicle is driven in 2WD mode normally.

The system is equipped with the control unit for switching the mode, and in the 4WD mode, the system splits the driving force between the front wheels (50%) and the rear wheels (50%).

Switching to 4WD

Select a proper driving mode by turning the 4WD switch dial according to the road condition (slipperiness, degree of slope, bumps).

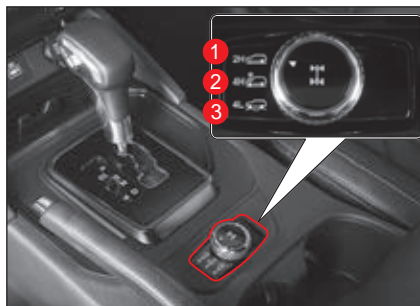

- 1 2WD (2H) mode
- 2 4WD HIGH (4H) mode
- 3 4WD LOW (4L) mode

Switching between 2H ↔ 4H mode

Set the mode to 2H or 4H by turning the 4WD selection dial when the vehicle speed is 70 km/h or less.

Switching between 2H and 4H ↔ 4L mode

Stop the vehicle on a flat ground, place the gear shift lever in the N (neutral) position and set the desired driving mode by turning the 4WD selection dial.



Caution

- When you switch the mode to the 4WD (4L or 4H) mode, be sure to drive the vehicle after the 4WD indicator turns on. Driving the vehicle before the indicator turns on may cause abnormal wear or burning of the driving gear.

Vehicle driving modes & indicators

Supervision type

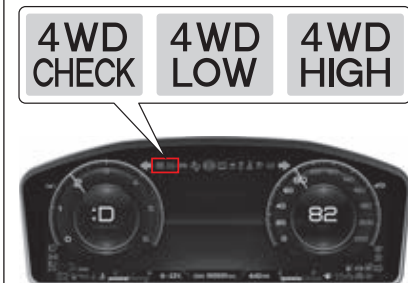

Standard type

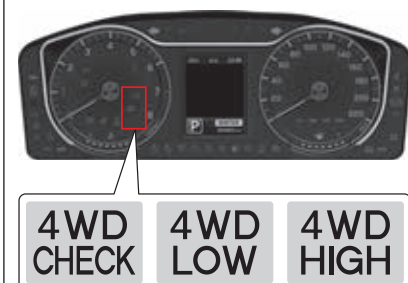

2WD (2H) mode

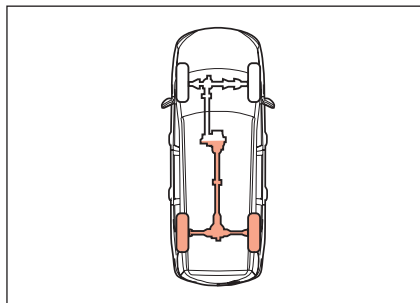

The 2WD (2H) mode is the status for 2WD high speed driving. Use this mode for normal or a high speed driving on a normal road or an expressway.

Notice

- The indicator does not turn on in the 2WD (2H) mode.

4WD HIGH (4H) mode

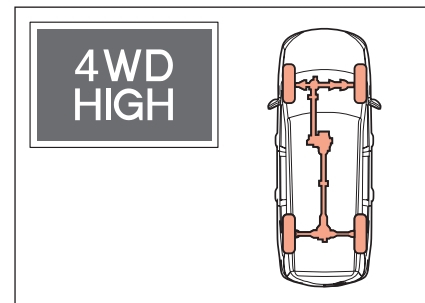

Use the 4WD HIGH (4H) mode for driving on a muddy road, a sandy road or a snowy road.

- When you switch the driving mode from the 2WD (2H) to 4WD HIGH (4H), the 4WD HIGH indicator turns on.
- When you switch the driving mode from the 4WD LOW (4L) to the 4WD HIGH (4H), the 4WD HIGH indicator blinks, and when it is switched completely, the 4WD HIGH indicator turns on.

4WD LOW (4L) mode

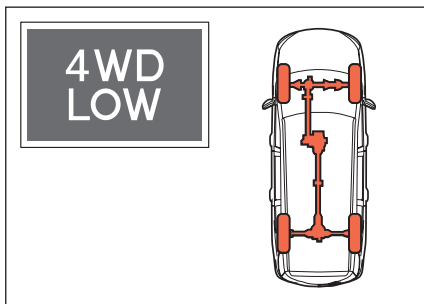

Use the 4WD LOW (4L) mode when the maximum traction power is necessary.

- When you switch the driving mode to the 4WD LOW (4L) mode, the 4WD LOW indicator blinks, and when it is switched completely, the 4WD LOW indicator turns on.
- When the 4WD LOW indicator blinks temporarily, it indicates that the driving mode is being shifted to the 4WD LOW (4L) mode.

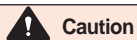

Caution

- In the 4WD LOW (4L) mode, avoid using the M (manual) 5th gear position or higher for to reduce damage to the driving system.

What is tight cornering?

Cornering in the 4WD (4L or 4H) mode may make the vehicle to shake or cause skidding or a shock in the driving system.

It is caused by the resistance of the internal power system according to the difference of revolving speed between the front wheels and the rear wheels and it indicates that the 4WD is operating normally.

Avoid rapid cornering in the 4WD mode since it may damage the power system.

4WD CHECK warning indicator



The 4WD CHECK warning indicator turns on if the 4WD switch unit is abnormal.



Caution

- If the 4WD CHECK warning indicator turns on, have your vehicle checked and serviced at a KG Mobility authorized service center.

Cautions for using the 4WD system

Caution

- Be sure to operate the 4WD switch dial for using the 4WD mode after starting the engine. However, the cancellation of 4WD in a vehicle (4WD status) whose engine cannot be started is also available when the START/STOP switch is in the ON status.
- When you operate the 4WD switch dial, mechanical noises and switching shocks may occur in the switching process. This is a normal phenomenon that occurs according to the mode change.
- Drive the vehicle on a normal road in 2WD mode, not 4WD mode. Driving the vehicle in 4WD mode on a normal road where the road surface is not slippery may damage the driving system.
- Driving the vehicle in 4WD mode on a normal road may cause unnecessary noises and tire wear and increase fuel consumption.
- Switch the driving mode to the 4WD LOW mode or from the 4WD LOW mode to another mode with the brake pedal depressed after stopping the vehicle completely.

- Avoid tight cornering in the 4WD mode since it may damage the power system.
- If the mode cannot be changed to the 4WD mode or the 4WD indicator, move the vehicle slightly, stop the vehicle and change the mode again with the gear shift lever in the N (neutral) position. This occurs when the gears do not interlock temporarily.
- If the 4WD CHECK warning indicator turns on, the 4WD function cannot be used. Have your vehicle checked and serviced at a KG Mobility authorized service center immediately.
- The vehicle equipped with the 4WD system should be towed by a flat-bed truck.

 Refer to "When you need to have your vehicle towed" (p.5-28)

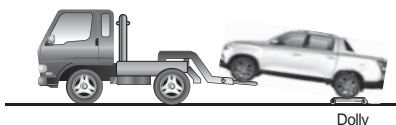

- If the 4WD mode is used, the vehicle performance is significantly affected according to the tire status.
 - Check the degree of tire wear and tire pressure periodically.
 - Be sure to use the same size and type tires from the same manufacturer on all wheels in a 4WD vehicle in order to prevent the damage to the driving system. When you replace the tires and wheels, replace all wheels in the same way together.

*LD (Locking Differential)

If a wheel is slipping or in the air, the locking differential improves the driving force of the vehicle by transferring most of the driving force to the wheel on the opposite side.

It is activated only when the difference in speed between the two wheels on the same axle increases rapidly. In other cases, the system performs the same function of a vehicle without LD.

Features

- Anti-slip for snowy conditions
- Better steering control on a slippery road surface
- Improved driving force (traction, gradability)
- Keeps driving safety in the event of crosswinds when turning



Caution

- **If one wheel on an axle is spinning faster than the other, avoid keeping the wheels spinning at high speed. The locking differential may fail.**
- **Rapid acceleration when driving out of the rough roads may cause the vehicle to sway.**
- **The LD is activated when there is a difference in speed between the two wheels on the same axle.**



Warning

- **For vehicles with LD, rotating the wheel which has been jacked up off the ground is prohibited. Activation of the LD transfers the driving force to the other wheel on the axle and the vehicle may move suddenly resulting in serious injury or death.**

Drive mode (with EPS)

Pressing the drive mode switch in normal driving condition will change the mode as follows:

- NORMAL → SPORT → WINTER → NORMAL



Caution

- Drive mode is a system where the electronic steering handle (Electronic power steering, EPS) and the automatic transmission shift pattern are interlinked, and the feeling of operating the vehicle may vary slightly depending on the drive mode which the driver selects.

Drive mode (without EPS)

Pressing the drive mode switch in normal driving condition will change the mode as follows:

- ECO → POWER → WINTER → ECO



Notice

- Winter mode is a function to minimize slippage when starting on the slippery road surface in winter.

ISG (Idle Stop & Go) System*

The ISG (Idle Stop & Go) system stops the engine when the vehicle is stationary and restarts the engine when driving resumes to improve fuel economy and reduce exhaust emissions.

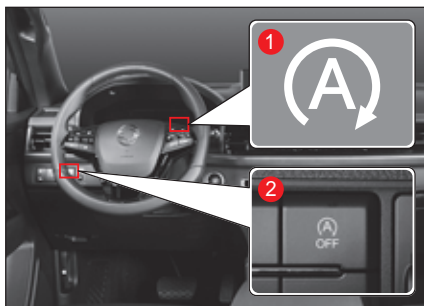

- ① ISG ON indicator
- ② ISG OFF switch

Caution

- Some warning lamps may light up momentarily when the engine is started by the ISG system. This is a normal phenomenon due to momentary current consumption.

Engine automatic shutdown

If the vehicle speed is 0 km/h (stationary) and the brake pedal is depressed while the ISG system is operating, the engine will automatically stop and the ISG green indicator (①) will illuminate on the instrument cluster.

At this time, cumulative engine-stop time (②) is displayed.



Notice

- The automatic shutdown of the engine by ISG system is maintained for up to 3minutes, and the engine restarts automatically after 3 minutes.

Automatic Engine Restart

When the engine is automatically stopped, releasing the brake pedal automatically restarts the engine. At this time, the green ISG indicator (①) lights up on the instrument panel and a restart message (②) is displayed.

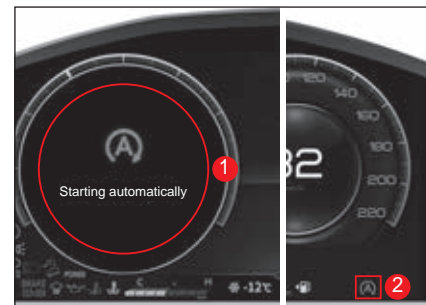

Notice

Engine restarts automatically when:

- Releasing brake pedal (AUTO HOLD disabled for vehicles with EPB) (restart after the indicator color changes green → white)
- Moving shift lever to R or +/- (for manual) position while depressing brake pedal
- Depressing accelerator pedal while depressing brake pedal

ISG system OFF

- 1 When you press the ISG OFF switch (1) to stop the ISG system, the ISG OFF indicator (2) lights up.
- 2 Pressing the ISG OFF switch again resumes normal operation of the ISG system and turns off the ISG OFF indicator on the instrument cluster.



Conditions for ISG system activation

- Driver's seat belt fastened
- Driver's door closed
- Engine hood closed
- Amount of accelerator pedal depression 10% or less
- Idling speed of 1,350 rpm or less
- Coolant temperature between 15°C and 105°C
- Appropriate level of brake negative pressure
- Battery sensor active and meets ISG condition
- Steering wheel 180° or less when stationary
- No certain signal to heater controller
- Gentle road slope
- Battery temperature between -5°C and 60°C
- Ambient temperature -2°C or higher
- Vehicle stops after moving at least 1 m (GSL only)
- Vehicle stops after reaching vehicle speed over 13 km/h
- No faulty ISG system-related parts
- Shift lever in D (drive) or N (neutral) position

Forced restart conditions

- Press ISG OFF switch to stop ISG system
- Engine coolant temperature higher than 110°C
- Heater and A/C Controller operating at maximum level (set Temperature 'Hi' or 'Lo')
 - Auto Controller: Set temperature 'Hi' or 'Lo' and Fan speed more than 6 level
 - Manual Controller: Set temperature Lowest or Highest and Fan speed more than 5 level
- Defroster in operation
- A/C in operation
- Changed indoor/outdoor temperature rapidly (based on temp. sensor)
- Poor battery charge level
- Vehicle speed over 2 km/h
- Engine automatic shutdown maximum time (3 min) elapsed
- Faulty components of ISG system and start system
- Release brake pedal and depress accelerator pedal slightly during AUTO HOLD execution
- Driver seat belt unfastened or driver's door open
- Steering wheel angle 180° or greater
- EPG in operation

Battery sensor (BSC)

The battery sensor (BSC) is fitted to the battery negative (-) terminal and monitors the battery information (such as voltage, current, temperature and charge status) and communicates with the EMS to operate the ISG (Idle Stop & Go) system.

When you disconnect the battery sensor connector to repair the vehicle or remove and refit the battery negative (-) terminal, the battery sensor will be deactivated and ISG system may have limited functionality.

If the battery sensor is deactivated, refer to the activation conditions to activate it prior to using the ISG system.

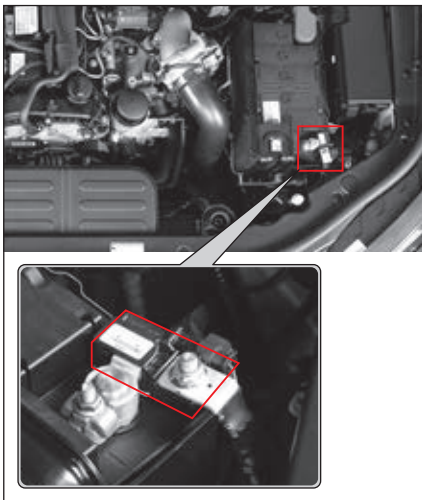

Conditions for activating battery sensor (BSC)

While the electrical equipment in the same condition as factory shipment is connected after re-installing the battery with the ignition switch off, if the vehicle monitors the battery voltage for more than about 3 hours and judges it to be stabilized, the battery sensor will be activated.



Caution

- **If the ISG system does not work after the battery sensor activation conditions are met, have the system checked and serviced at the nearest KG Mobility Authorized Service Center.**



Warning

- **When replacing the battery, always replace with the our genuine ISG system battery (AGM). Otherwise, it may result in serious system failures, battery damage, and explosion due to overcharging, etc.**

Cruise control system*

The cruise control system is an auxiliary convenience system that allows the driver to drive the vehicle at a set speed without depressing the accelerator pedal with the flow of traffic where more than a legal safe distance is secured.

The cruise control system is not a safe driving system. Be sure to always drive the vehicle while paying attention to the vehicle speed and surrounding situations.

The cruise control system can be activated when the vehicle is driven at a speed of approximately 40 km/h or greater and less than 180 km/h.

Conditions for using the cruise control

Be sure to use the cruise control only under the following traffic and road conditions.

- Use the cruise control when the current traffic condition is light.
- Use it only on a driveway or an expressway where no change in the vehicle driving condition due to traffic lights, vehicles, pedestrians or other factors is expected.
- Do not use it on a normal road.

Warning

- Use the cruise control system only on a motorway or an expressway where the road is in good condition.
- Stop using the cruise control system in the following road conditions since control may become impossible, causing an accident.
 - When a strong wind or a side wind blows
 - When there is traffic congestion
 - Slippery road, sloping road or continuously curved road

Cruise control switch and indicator

Cruise control switch

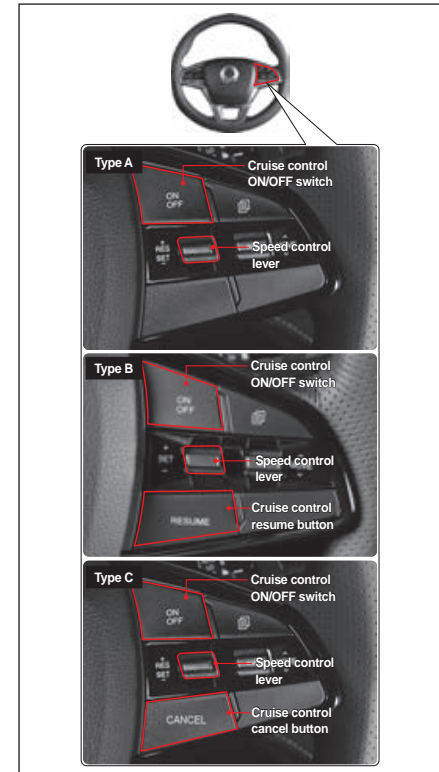

Cruise Control Ready / Enabled Display

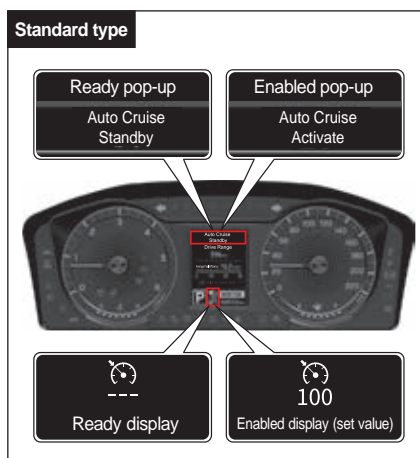
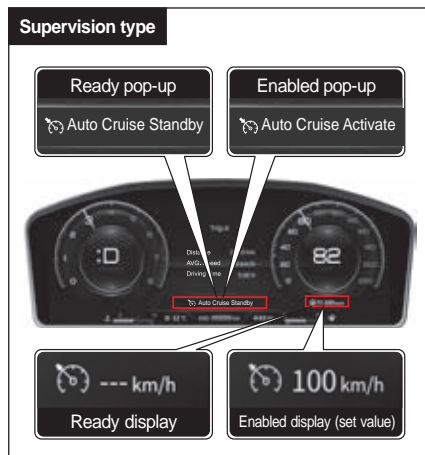

Auto cruise READY

The following message is displayed on the instrument panel LCD screen and the system enters auto cruise READY mode when you press the cruise control ON/OFF switch.

- “Auto cruise READY” pop-up displayed
- Symbol and “--- km/h” indicating that system ready to display speed displayed

Auto cruise ENABLED

When the cruise control is in the Ready mode and the speed control lever is lowered, the following message is displayed on the instrument panel LCD screen and the cruise control is enabled.

- “Set Auto Cruise” pop-up displayed
 - Symbol and set speed, “100km/h” displayed
- The cruise control works when driving at a vehicle speed of about 40 km/h or higher.

Setting the cruise control driving speed

- 1 Press the cruise control ON/OFF switch.
The READY indicator on the instrument cluster turns on.
- 2 Adjust the vehicle speed so that the speed range for the cruise control operation is between approximately 40 km/h and 180 km/h.
- 3 Set the desired driving speed by raising or lowering the speed control lever of the cruise control in the RES+ (SET+) or the SET- direction.

Now, the vehicle is driven at the set speed without depressing the accelerator pedal.

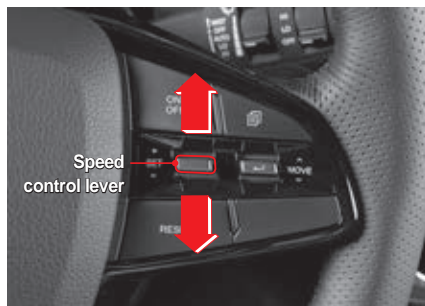

Warning

- Activate or deactivate the function after fully familiarizing yourself with the cruise control system. The cruise control operation speed should be set while driving. Operating it improperly or without fully familiarizing yourself with the system may lead to an accident.
- When you activate the cruise control while driving, do not change the gear shift lever to the N (neutral) position. Doing so may damage the relevant system or cause an accident.
- When you drive the vehicle at a fixed speed with the cruise control system activated, be sure to drive safely in order to be able to deal with any situation that can occur on the road and drive the vehicle in a way that you can operate the brake pedal and the accelerator pedal immediately.
- Be sure to always secure safe braking distance, depress the brake pedal if necessary.
- The actual speed for driving up or down a hillside road may be slightly different from the set speed. Avoid using the cruise control system on a hillside road or a sloping road if possible.
Use the engine brake and the foot brake on a steeply sloping road for driving safely and protecting the vehicle system.

Caution

- While you are not using the cruise control, turn off the READY indicator by pressing the cruise control ON/OFF switch.

Notice

- To reset the cruise control operation speed, carry out Step No. 2 and No. 3 again with the cruise control activated.
- Refer to the following contents for the detailed operation for each vehicle operation condition.

Speed acceleration process of the cruise control

When the cruise control system is activated

To increase the set vehicle speed while driving with the cruise control activated, push the speed control lever up in the RES+ (SET+) direction with the accelerator pedal not depressed.

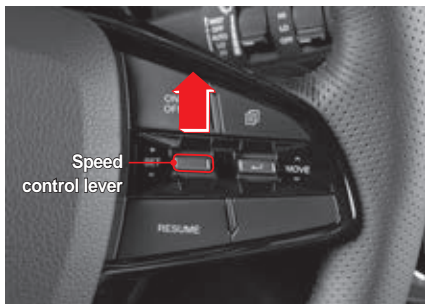

- Pushing the speed control lever up briefly once increases the speed by 1 km/h.
- Pushing and holding down the speed control lever increases the set speed of the vehicle continuously.

When the cruise control system is not activated

The following steps describe how to activate the cruise control system when it is not activated and raise the set vehicle speed.

- 1 Press the cruise control ON/OFF switch.
The READY indicator on the instrument cluster turns on.
- 2 Depress the accelerator pedal until the vehicle speed becomes approximately 40km/h or higher in order to activate the cruise control.
- 3 When the desired set speed is reached, adjust the speed by pressing the speed control lever in the RES+ (SET+) or the SET- direction.

Pushing and holding down the speed control lever up in the RES+ (SET+) direction increases the set vehicle speed slowly.

- 4 After setting the speed, take your foot off from the accelerator pedal slowly.

Increasing the set speed by phases with the cruise control activated

To increase the speed cruise control slightly by phases with the cruise control activated, carry out the following steps.

- Push the speed control lever up briefly in the RES+ (SET+) direction (within 0.5 second). The set vehicle speed increases by approximately 1 km/h each time you push the speed control lever up.
- For example, if you wish to increase the set vehicle speed by approximately 10 km/h, push the speed control lever up briefly in the SET+ direction 10 times.

Speed deceleration of the cruise control

When the cruise control system is activated

To decrease the set vehicle speed with the cruise control activated, push the speed control lever down in the SET- direction with the brake pedal not depressed.

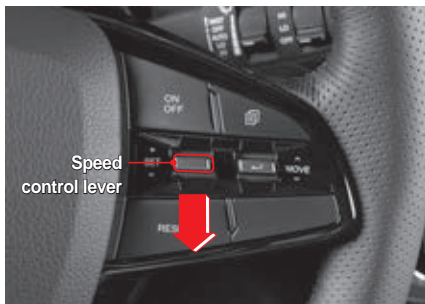

- The set vehicle speed decreases by 1 km/h each time you push the speed control lever down briefly.
- Pushing and holding the speed control lever down continuously decreases the set vehicle speed continuously.

However, when the vehicle speed becomes approximately 34 km/h or less, the cruise control function is deactivated.

Decreasing the set speed by phases with the cruise control activated

To decrease the speed cruise control slightly by phases with the cruise control activated, carry out the following steps.

- Push the speed control lever down in the SET- direction briefly (within 0.5 second). The set vehicle speed decreases by approximately 1 km/h each time you push the speed control lever down.
- For example, if you wish to decrease the set vehicle speed by approximately 10 km/h, push the speed control lever down briefly in the SET- direction 10 times.

Deactivating the cruise control

When the following deactivation signal is detected with the cruise control activated, the cruise control system is deactivated (READY indicator turns on).

Deactivation condition

- When the brake pedal is depressed for braking
- When the cruise control ON/OFF switch is operated once (cancel the operation when the switch is operated twice)
- When the gear shift lever is shifted to the N (neutral) position while driving

Other deactivation conditions according to the vehicle condition

- When the Electronic stability control system (ESP) is activated
- When the decelerated speed of the vehicle is approximately 34 km/h or less
- When the parking brake is depressed while driving
- Clutch pedal is depressed to shift (M/T only).

- The speed increases or decreases drastically (GSL only).
 - when driving at more than 20 km/h above the set speed
 - when driving at less than 20 km/h below the set speed
 - when driving at 140 km/h or more for 4 minutes or longer
- When the cruise control switch is abnormal
- When an abnormal signal from the brake system is detected
- When the engine RPM is approximately 4,400 rpm or higher

If normal conditions for the deactivation of cruise control are not met or an intermittent malfunctions occur, turn off the engine, wait for a little bit and start the engine again. The system is resets so that you can activate the system normally.

Resuming the cruise control

When the cruise control is deactivated due to the cruise control operation stop signal, the cruise control can be resumed.

Press the RESUME (CANCEL) button with the vehicle speed of approximately 40 km/h or higher and the brake pedal and the accelerator pedal not depressed.

- The last set speed memorized before the cruise control was deactivated is resumed.
- The AUTO CRUISE indicator on the instrument cluster turns on.

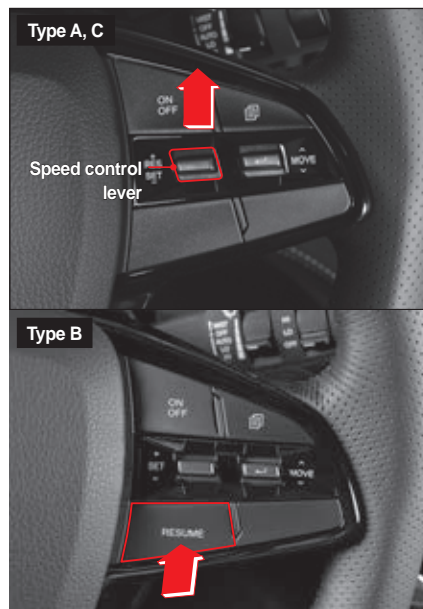

Intelligent / Adaptive Cruise Control*

Intelligent cruise control system

This system keeps the vehicle speed constant even if the driver does not depress the accelerator pedal and brake pedal. When a preceding vehicle is detected, it keeps the distance to the preceding vehicle constant at the preset distance. It allows the vehicle to travel in the middle of the lane via steering wheel (steering force) control.

Adaptive cruise control system

This is a convenient device to keep the vehicle speed constant even if the driver does not depress the accelerator pedal and brake pedal. When a preceding vehicle is detected, it keeps the distance to the preceding vehicle constant at the preset distance.

Intelligent Cruise Control Ready / Enabled Display

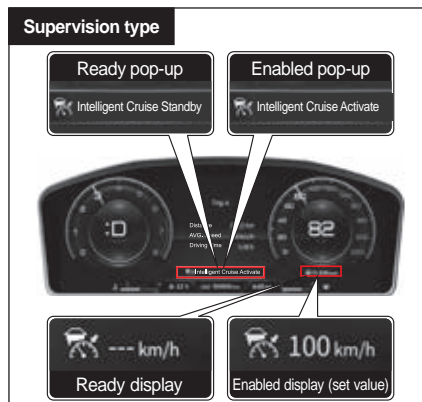

Intelligent Cruise Control Ready

During the intelligent cruise control (IACC) operation, when the standby conditions such as the brake pedal are satisfied, the following messages are displayed on the LCD of the instrument cluster and the intelligent cruise control enters standby mode.

- “Intelligent cruise READY” pop-up displayed
- Symbol and “--- km/h” indicating that system ready to display speed displayed

Set intelligent cruise (enabled)

When the intelligent cruise control is in the Ready mode and the speed control lever is lowered, the following message is displayed on the instrument panel LCD screen and the intelligent cruise control is enabled.

- “Intelligent cruise set” pop-up displayed
- Symbol and set speed displayed

The adaptive cruise control works when driving at a vehicle speed of about 10km/h or higher.

Notice

- **The description in this section is based on the intelligent cruise control. Steering wheel (steering force) control does not work when the adaptive cruise control system is operating.**

To enable intelligent cruise control at instrument cluster

- Supervision type / Standard type
Go to Driving Assist Setting → Intelligent Adaptive Cruise Control under  (User Settings) in the instrument cluster and tick the box.

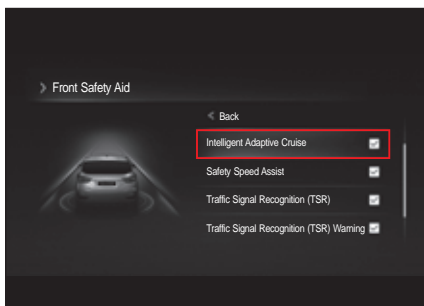

To set intelligent cruise control

- 1 Press the cruise control ON/OFF switch. The intelligent cruise control (IACC) is activated.
- 2 Adjust the vehicle speed within the operating speed range of the intelligent cruise control.
 - Set speed (30 km/h ~ 180 km/h)
 - Operating speed (0 km/h ~ 150 km/h)
- 3 Lower the cruise speed selector lever toward SET- to enable the cruise control.
 - “Intelligent cruise control set” message is displayed on the instrument cluster.
 - Then, the vehicle maintains the set speed without depressing the accelerator pedal and keeps driving in the middle of the lane via steering wheel (steering force) control.
 - If a preceding vehicle is detected, the driver’s vehicle will travel while maintaining a set distance to the vehicle ahead.

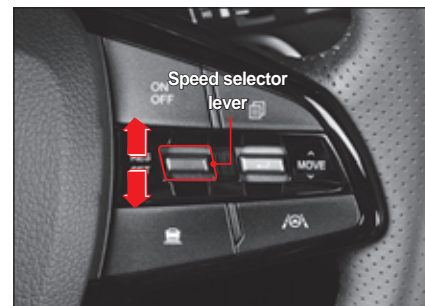

Caution

- The vehicle speed may decrease or increase temporarily on uphill or downhill while the intelligent cruise control is operating.

Increasing speed

To increase the set speed during intelligent cruise control operation, push the speed selector lever up toward RES+ without depressing the accelerator pedal.

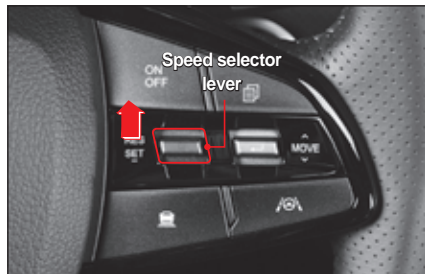

- Each time you push up the speed selector lever briefly, the speed increases by 5 km/h.
- If you push up the speed control lever for a long time, the speed increases by 10km/h. The vehicle setting speed increases continuously while the lever is being raised. (The set speed increases by a factor of 10.)
- You can set up to 180 km/h.

Caution

- Since if you push up and hold the lever the vehicle speed increases quickly, be careful of the surrounding situation when operating.

Decreasing speed

To decrease the set speed during intelligent cruise control operation, push the speed selector lever down toward SET- without depressing the accelerator pedal.



- Each time you push down the speed selector lever briefly, the speed decreases by 5 km/h.
- If you push down and hold the speed selector lever, the speed decreases by 10 km/h. The set speed decreases continuously while the lever is being lowered. (The set speed decreases by a factor of 10.)
- The lowest settable speed is 30 km/h.

Temporary acceleration (override)

Depress the accelerator pedal to accelerate the vehicle temporarily while intelligent cruise control is in operation.

Temporary acceleration is possible by driver's will without affecting the set speed.

In order to return the set speed, release the accelerator pedal. The vehicle will travel at the set speed.

Caution

- If you depress the accelerator pedal for more than about 60 seconds for temporary acceleration, the intelligent cruise control system will stop operating.

Deactivating

If the deactivation signals below are detected while intelligent cruise control (IACC) is operating, the intelligent cruise control (IACC) will be deactivated. (It enters standby mode)

Disable conditions

- Brake pedal depressed for braking
- Cruise control ON/OFF switch pressed once (pressing twice deactivates system)
- Depressing accelerator pedal for more than 60 sec (override)
- Electric vehicle posture stability control system in operation (e.g., ESP, TCS and ABS)
- Electric vehicle posture stability control system OFF (by ESP OFF switch)
- Shift lever in positions other than D (drive)
- EPB applied
- Driver's door open
- Maximum adaptive cruise control speed (180 km/h) exceeded
- Engine speed below 350 rpm or above 7,000 rpm

- 3rd warning, emergency braking applied by AEBS
- HDC system in operation
- Heavily contaminated radar sensor cover

Other disable conditions

- No preceding vehicle at the time of restart after vehicle stop by control
- Distance to front vehicle too far or too close during vehicle stop control
- Vehicle stop control occurs frequently

Notice

- **If "Intelligent cruise control READY" message is displayed on the instrument cluster with the disable conditions met, when you push up the speed selector lever toward RES+ briefly, the intelligent cruise control is reactivated.**

If the intelligent cruise control is disabled, check the road situations and driving conditions. In addition, depress the brake pedal to adjust the vehicle speed properly.

Supervision type

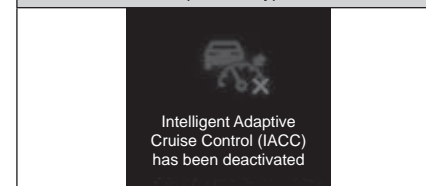

Notice

- **The message is displayed if the intelligent cruise control is disabled abnormally.**

Resume

If the intelligent cruise control is disabled (intelligent cruise control ready), you may reactivate it.

Push up the speed control lever toward RES+ briefly at a vehicle speed of about 10km/h or higher without depressing the brake pedal or accelerator pedal.

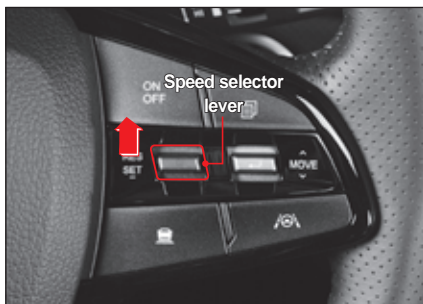

- The set speed returns to the value before intelligent cruise control was disabled.

! Caution

- **When resuming, the vehicle speed can be increased or decreased quickly to the set speed just before it is disabled. Be aware of the surrounding road conditions before resuming.**

If the following message is displayed on the instrument cluster while the vehicle is stationary, push up or lower the speed selector lever briefly toward RES+ or SET-.

Then, the intelligent cruise control resumes.

Depressing the accelerator pedal also resumes the intelligent cruise control.



When front vehicle departs, operate RES, SET button or pedal

To Deactivate

In order to completely deactivate the intelligent cruise control (IACC), press the cruise control ON/OFF switch.

- Intelligent cruise pop-up disappears on the instrument cluster.

When not using the intelligent cruise control, always press the switch to deactivate it.

! Caution

- **If you depress the accelerator pedal for more than about 60 seconds for temporary acceleration, the intelligent cruise control system will stop operating.**





Warning

- When not using the intelligent cruise control, always turn off the system.
- Always set the speed of the intelligent cruise control within the speed range specified by law.
- Check the surrounding road conditions prior to using the intelligent cruise control.
- Do not use the intelligent cruise control under following circumstances:
 - Near high interchange and tollgate
 - Where there are a lot of metals around road such as construction site and iron tunnel
 - Where lanes and guard rails in close proximity
 - Where there is no lane such as parking lot
 - Uphill or downhill with steep incline
 - Poor visibility due to factors such as fog, heavy rain, heavy snow, etc.
- The intelligent cruise control is a convenience feature for the driver. Do not use it as a safety device.
- The vehicle control should be determined by the driver at his/her own discretion. Relying on intelligent cruise control only increases the risk of accidents.

Steering wheel (steering force) control alert

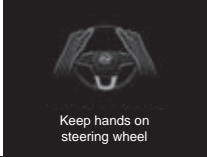
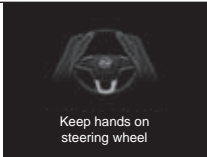
If the driver does not hold the steering wheel while driving during intelligent cruise control's steering wheel control, the hands-off warning will be displayed to the driver in 3 steps and the intelligent cruise control system stops operating.

Supervision type	
	Keep hands on steering wheel
Step 1: Message <ul style="list-style-type: none"> • Warning message is displayed. 	
	Keep hands on steering wheel
Step 2: Message + Beep <ul style="list-style-type: none"> • Warning message is displayed and beep sounds. 	

Supervision type	
	Keep hands on steering wheel
Step 3: Message + Beep (different from step 2) <ul style="list-style-type: none"> • Warning message is displayed, and a beep different from one in step 2 will sound. 	
	Intelligent Adaptive Cruise Control (IACC) has been deactivated
System deactivated: Message + System disabled <ul style="list-style-type: none"> • "Intelligent Adaptive Cruise Control (IACC) has been deactivated" message is displayed and steering control is disabled at the same time. However, the cruise control still functions. 	



Caution

- If the driver hold the steering wheel so weakly that there is no left or right movement when driving on a straight road, the system may determine that the driver does not hold the steering wheel and may generate a hands-off warning.
- Hands-off warning may be issued late depending on the road conditions. Always hold the steering wheel while driving.



Caution

The steering wheel (steering force) control system may not function or intervene unnecessarily under following circumstances:

- The system cannot recognize the lane markings because of rain, snow, dust, standing water or puddles, other obstruction on the road.
- The color of the lane markings is not clearly distinct from the road color.
- The lane markings are not clear or tampered by the traffic, or there are 2 or more lane markings on one side.
- There are other markings similar to the lane markings on the roads.

- The lane markings are covered in shadows of the median barriers, guardrails, noise barrier walls, roadside trees.
- There are environmental barriers, such as bollard.
- The traffic is heavy due to the construction in the area or traffic control items, such as traffic cones, are used to separate traffic flows.
- The lane markings are suddenly discontinued at roundabouts and road intersections.
- The vehicle is passing through a certain section, such as highway interchange, where the number of lanes increases or decreases.
- The width of the driving lane is too narrow or wide.
- The distance to the vehicle ahead is too short or a wheel of the vehicle ahead is touching the lane marker.
- There are other roadway markings on the roads, such as crosswalk markings, arrows, symbols, along with the lane markings.
- Poor visibility due to factors such as fog, heavy rain, heavy snow, etc.
- Hard to recognize other vehicles and pedestrians because of poor visibility.
- There is rapid change of illumination, for example at tunnel entry and exit points.

- The headlamps are not turned on or the brightness of the lamps is too low when driving at night or through tunnels.
- When you are traveling within or near the outer edges of the bus-only lane.
- The vehicle is driven on a steep hill or around sharp corners.
- the vehicle is driven under specific conditions which cause severe vibration.
- Objects with reflective surface (white paper, mirror, etc.) are on the dashboard.
- The windshield glass in front of the camera module is covered with ice, snow, slush, mud, dirt or debris.
- Fog or mist on the windshield.
- The temperature around the front view camera is too high because of the direct sunlight.
- The vehicle is moving towards a light source.
- The light from the sun, streetlamps, or headlamps of oncoming vehicles is reflected by the wet road surface.
- Bend such as sharp S-curve

To set safety distance to front vehicle

If the preceding vehicle is detected while the intelligent cruise control is operating, this system allows the driver's vehicle to maintain a distance to the preceding vehicle constant.

If the intelligent cruise control is activated, it will operate with the previously set safety distance without separate operation. If necessary, press the safety distance set button to change the inter-vehicle distance (safety distance) in 5 steps.

Set the safety distance according to the current vehicle speed.

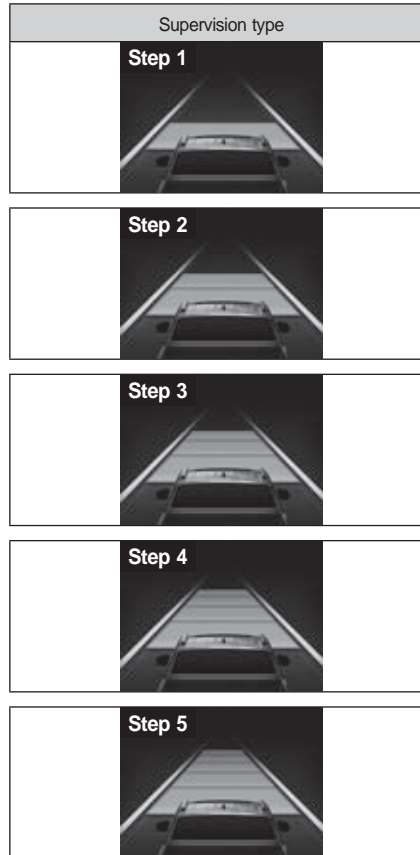

- If no preceding vehicle is detected, the vehicle travels at a speed set to the intelligent cruise control system.
- When the preceding vehicle accelerates and the inter-vehicle distance increases, the driver's vehicle accelerates only up to the set speed and then travels at constant speed.

Forward situation awareness



If the distance to the front vehicle is so close that a collision can occur or the front vehicle disappears from the front view due to lane change, etc. while the intelligent cruise control is activated, the message is displayed on the instrument cluster.

- If the driver has to operate the brake pedal or steering wheel, immediately reduce the vehicle speed or change the direction.



Caution

- **If the front vehicle disappears from the front view due to lane change, etc. while traveling and maintaining the distance to the front vehicle constant at a low speed the driver's vehicle may collide with a newly appearing stationary vehicle or object.**

Starting at congested areas

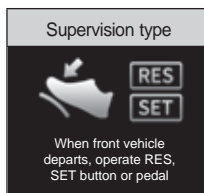

When the intelligent cruise control is operating, in congested areas, drive the vehicle while maintaining the distance to the front vehicle constant. Depress the accelerator pedal or push up the speed selector lever toward RES+ briefly or lower it toward SET- briefly to restart the vehicle 3 seconds after since the vehicle stops due to the front stationary vehicle.

Front detection sensor (Front radar + front camera)

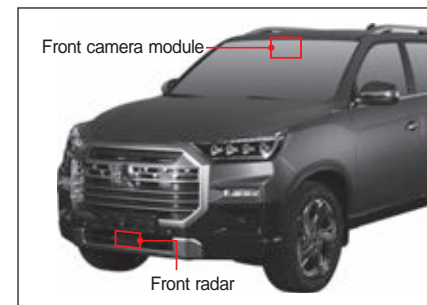

Front radar

It is a sensor that detects the front vehicle and allows the driver's vehicle to maintain the distance to the front vehicle constant and follow the front vehicle. If snow, rain, or foreign objects are stuck around the front sensor, the sensing performance of the sensor may deteriorate and intelligent cruise control may not function or may be temporarily disabled. Always keep the area around the front radar sensor clean.

Front camera

The camera detects the lane ahead of the vehicle through the sensor of the front camera module (FCM), allowing the vehicle to maintain the middle of the lane during intelligent cruise control operation. Always keep the area around the front camera module clean.



 **Caution**

- **Always keep the area around the front detection sensor clean and never attach any accessory (license plate molding, sticker etc.).**
- **Be careful not to damage the sensor due to high-pressure washing or to prevent water from entering during car washing (lower part).**
- **After car washing, be sure to wipe off moisture around the sensor.**
- **Avoid subjecting the front bumper to impacts. The impact may change the sensing area of the sensor.**
- **Use a genuine sensor only.**
- **Do not paint the front bumper arbitrarily.**

Vehicle detection is difficult under the following circumstances:

- Driving on a steep hill or sharp corners
- Driving under specific conditions which cause severe vehicle vibration
- A vehicle or a pedestrian recklessly cuts in front of you
- There is an approaching or reversing vehicle
- there is a vehicle with arbitrary shape
- Vehicle traveling close to one side lane or ahead
- Vehicle traveling at a very low speed or performing abrupt deceleration
- Stationary vehicle
- Vehicle with narrow rear structure (trailer, motorcycle, bicycle, etc.)
- When driving on a narrow road or a road with heavy curve
- When operating steering wheel
- When front part of vehicle lifted upwards due to excessive load in luggage compartment
- Foreign object stuck in sensor due to snow, rain, fog, etc.
- Vehicle which moves or is parked perpendicular to the direction of travel for your vehicle

 **Caution**

- **The system may not recognize the preceding vehicle under the circumstances described earlier. Special care is required. Always be careful of motor traffic and reduce the vehicle speed by depressing the brake pedal, if needed.**

Not detected preceding pedestrian

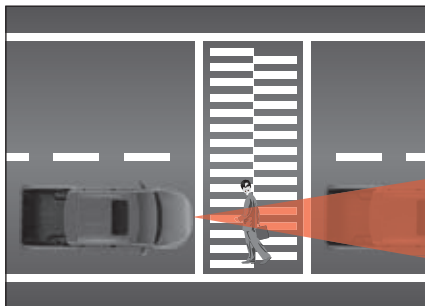

- The intelligent cruise control may not detect people.
- When traveling while maintaining the inter-vehicle distance, if a pedestrian appears in front of your vehicle, which can cause a dangerous situation.

Curved road

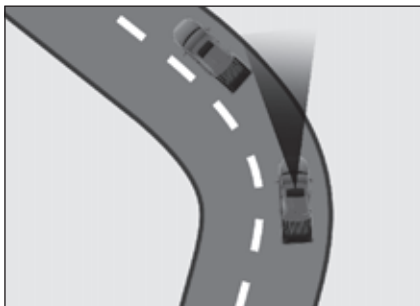

- The system may fail to recognize a preceding vehicle in the same lane on a curved road and accelerate the vehicle to the set speed rapidly.
- If the preceding vehicle is suddenly detected, the vehicle speed may decelerate rapidly.
- Always be careful of motor traffic and reduce the vehicle speed by depressing the brake pedal, if needed.



- It may detect a vehicle in a different lane on a curve and which may affect the driver's vehicle speed. Always be careful of motor traffic and reduce the vehicle speed by depressing the brake pedal.
- In this case, check the traffic conditions around you, then step on the accelerator pedal to prevent unnecessary deceleration.

Uphill or downhill

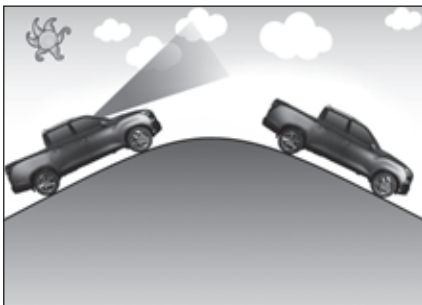

- The vehicle may accelerate to the driver set speed rapidly by failing to recognize a preceding vehicle in the same lane on an uphill or downhill.
- If the preceding vehicle is suddenly detected, the vehicle speed may decelerate rapidly.
- Always be careful of motor traffic on the uphill or downhill and reduce the vehicle speed by depressing the brake pedal, if needed.

To change lane

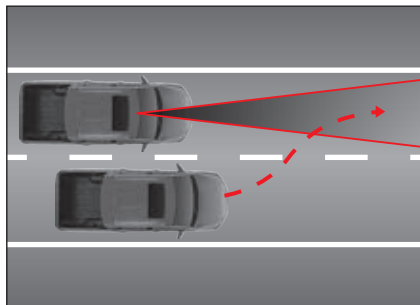

- When a vehicle in the lane next to you enters the same lane, the system may fail to recognize this vehicle until it enters into the sensor detection area.
- Be cautious at all times since the sensor may detect a vehicle cutting in suddenly late.
- Make sure to decelerate to maintain the vehicle-to-vehicle distance when an interposing vehicle's speed is lower than the driving speed.
- Make sure to keep the set speed to maintain the distance to a preceding vehicle when an interposing vehicle's speed is faster than the driving speed.

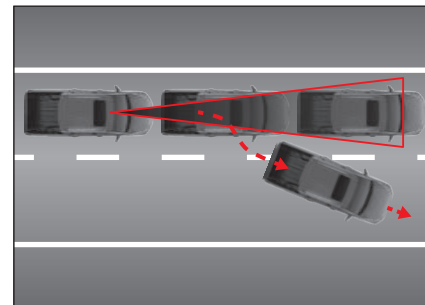

- If the front vehicle leaves the lane due to lane change, etc., be careful that there is a risk of collision because the system can not detect another vehicle ahead.

Detecting vehicle ahead

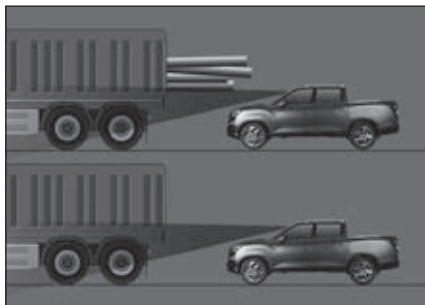

- Your attention is always required while driving behind a vehicle carrying cargo longer than the cargo bed or with high ground clearance because the AEBS may not work properly.

Warning

- In the event of an emergency, always stop the vehicle by depressing the brake pedal.
- Keep safety distance at all times. In particular, if you set the distance to the preceding vehicle to closer at high speed, it can cause a very dangerous situation such as collision with the front vehicle.
- The adaptive cruise control system can not cope with the vehicles parked in front, vehicle stopping suddenly, pedestrians, vehicles coming on opposite sides, etc. The driver should always be careful to look ahead and respond to unforeseen circumstances.
- If the preceding vehicle changes lanes frequently, the sensor recognition response rate may be slower. The driver should always be careful to look ahead and respond to unforeseen circumstances.
- The adaptive cruise control is a convenience device for the driver and not a safety device. The safe maneuvering and controls are always the driver's responsibility.

Warning

- The driver should always be aware of the adaptive cruise control set speed and distance to the front vehicle.
- Always allow for extra distance between your vehicle and the vehicle ahead. Reduce the vehicle speed by depressing the brake pedal, if needed.
- The adaptive cruise control can not recognize complicated traffic conditions, so you should always be careful about traffic conditions while it is operation and the driver must adjust the vehicle speed personally in dangerous situations.
- To use the adaptive cruise control more safely, be sure to read and familiarize yourself with the user manual before using it.

Caution

- The adaptive cruise control may be deactivated in an instant by strong electromagnetic waves.

Brake system

Warning Light and Indicator Related to Brake



ABS warning light



Brake warning light



EBD warning light



ESP warning light



ESP OFF indicator



HDC indicator

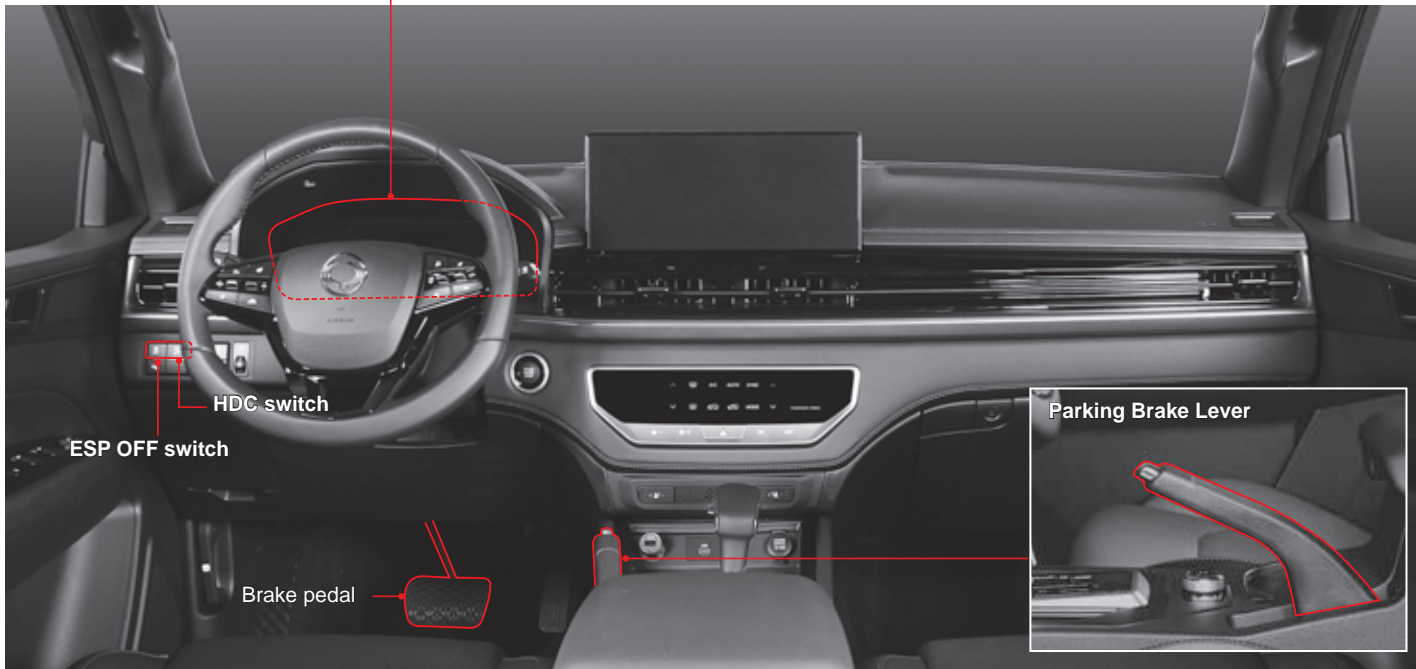

Foot brake

Depressing the brake pedal can reduce the vehicle speed or stop the vehicle.

If the foot brake is used for a long period of time on a long downhill road, the fade or vapor lock phenomenon may occur due to the overheating of the brake system, reducing the braking performance and causing an accident.

Use the engine brake with a lower gear along with the foot brake on a long downhill road.



Caution

- Reduce the speed properly using the engine brake on a slippery road such as an icy road or a snowy road.

What is the fade phenomenon?

The fade phenomenon is the reduction of braking force due to a decrease in the friction force caused by a temperature increase in the friction surface of a brake when the brake is applied excessively on a long downhill road.

What is the vapor lock phenomenon?

The vapor lock phenomenon is the condition that when the brake is applied excessively on a downhill road, bubbles form in the brake fluid in the wheel cylinder or brake pipe of the hydraulic brake so that proper hydraulic pressure cannot be transferred, causing the brake system not to operate properly even if the pedal is depressed.



Warning

Checking for foreign materials on the pedal operation area



- Before driving the vehicle, clean up the area where the brake pedal or the accelerator pedal is operated. If an empty can or an article is present below the pedal, it may obstruct the pedal operation, causing an accident. Be sure to check before driving the vehicle.

Checking and replacing the brake pads/discs

Check the brake pads and discs at every 10,000 km of driving and replace if necessary. When replacing the brake pad, replace the left and right brake pads at the same time.

The replacement period of the brake pads and discs may vary depending on the driver's driving habit.



Warning

- **If you hear a screeching sound when you depress the brake pedal, have your vehicle checked and serviced at a nearby KG Mobility authorized service center. Failure to do so may cause the brake not to operate, causing a serious accident.**

If the brake is not working

If the foot brake is not working while driving, decelerate the vehicle speed as much as possible using the engine brake and stop the vehicle safely by applying the parking brake slowly.

ABS (Anti-Lock Brake System)*

If you apply sudden braking or apply braking on a slippery road, the vehicle continues to move forward but the wheels are locked, not rotating. In such case, steering may not be possible or the vehicle may spin, causing an accident.

In such case, the ABS controls the locking of the wheels properly to maintain the steering force and improve the steering stability of the vehicle.

In normal driving conditions, the braking system of a vehicle equipped with the ABS operates in the same way as the braking system of a normal vehicle.



Warning

- **The ABS system prevents a situation that the wheels are locked, disabling the steering of the vehicle, when the braking is applied. Therefore, the ABS system does not affect the braking distance significantly.**
- **When the ABS system operates and the braking force is created, the braking distance may become longer or shorter than the braking distance of a vehicle without the ABS system according to the road surface condition.**
- **When applying a sudden braking, depress the brake pedal strongly until the vehicle stops completely. Never take your foot off from the pedal or depress the pedal in a pumping manner.**
- **Even a vehicle equipped with the ABS system cannot prevent a risk of the vehicle skidding sideways. Be sure to keep a proper safe distance from a preceding vehicle and drive the vehicle at a low speed on a slippery road.**



Caution

- A vehicle equipped with the ABS system performs the self-diagnosis function to check whether the system is abnormal or not after the engine is started and the vehicle is driven. In this process, the hydraulic pressure is transferred to the internal hydraulic system forcibly and the motor operates accordingly, so noises and vibrations may occur on the brake pedal. This indicates that the ABS is functioning normally.
- When the ABS system operates, you may feel vibrations through the brake pedal along with some noise. This is a normal phenomenon that occurs when the ABS system operates.

ABS warning light



This warning light turns on when the START/STOP switch is in the ON status and it turns off if the system is normal.



Warning

- If the ABS warning light stays on after the engine is started or it turns on while driving, this indicates that an ABS-related system is abnormal, and the ABS system does not operate and only normal braking function is activated. In such case, have your vehicle checked and serviced at a KG Mobility authorized service center promptly.

Electronic Brake-Force Distribution (EBD)

The EBD system distributes the braking force to the front wheels and the rear wheels efficiently by controlling the braking pressure electronically when the brake pedal is depressed.

The EBD system is activated when the speed difference between the fastest front wheel and the slowest rear wheel is approximately 1 km/h or more, and it is deactivated when the ABS operates.

EBD warning light*



When the ABS warning light and the brake warning light turn on at the same time, it indicates that the EBD system is abnormal. (There is no separate EBD warning light.)



Caution

- When the EBD warning light turns on, have your vehicle checked and serviced at a KG Mobility authorized service center.

Emergency Stop Signal (ESS)*

The ESS function informs of a dangerous situation to a following vehicle by blinking the emergency braking light fast when a sudden braking is applied or the ABS system operates while driving.

The ESS function operates when the vehicle speed is 50 km/h or higher, and it operates in the sequence of "Input ESS signal" → "Operate emergency braking light" → "Operate the hazard warning lamp".

Notice

- If the hazard warning lamp is on, the ESS function is not activated.

Activation and deactivation conditions

	Emergency braking light
Activation conditions	<ul style="list-style-type: none">• When the vehicle speed is 50 km/h or higher• When a sudden braking with the vehicle deceleration of 6.5m/s² or higher is applied• When the ABS system is operating while applying braking
Deactivation conditions	<ul style="list-style-type: none">• If there is no ESS from the vehicle• When the hazard warning lamp is activated• When the ABS operation is finished

	Hazard warning lamp
Activation conditions	<ul style="list-style-type: none">• If the vehicle speed is 50km/h or less at the time when the operation of the hazard warning lamp indicator is finished (canceled)• If the hazard warning lamp blinks for 10 seconds
Deactivation conditions	<ul style="list-style-type: none">• When the hazard warning lamp is activated• When 10 seconds have passed after the hazard warning lamp is activated• When the vehicle speed has increased by 10 km/h or more after the hazard warning lamp is activated

Electronic stability control system (ESP)*

The ESP system is an auxiliary driving safety system that controls the braking of each wheel or the engine output in order to correct the vehicle stability when it becomes unstable such as rapid cornering, helping the vehicle to avoid a dangerous situation.

- The ESP function is activated only when the vehicle becomes extremely unstable and it is not activated in normal driving conditions. You can confirm its activation from the blinking of the ESP indicator on the instrument cluster.

ESP indicator/warning light



- Indicator blinks: When the ESP function is activated
- Warning light turns on: When the ESP system is abnormal

Caution

- If the ESP indicator blinks, drive slowly without accelerating.
- If the ESP warning light turns on, visit a KG Mobility authorized service center and have your vehicle checked and serviced.

Notice

- The hazard warning lamp blinks for approximately 10 seconds to allow a vehicle right behind or around to prepare in advance when you apply sudden braking at the vehicle speed of 50 km/h or higher or the ABS system operates. (Emergency Stop Signal)

ESP OFF indicator



When you deactivate the ESP by pressing and holding down the ESP OFF switch (for 3 seconds or more), the indicator turns on.

Caution

- If the ESP OFF indicator stays on even though you did not deactivate the ESP function, visit a KG Mobility authorized service center and have your vehicle checked and serviced.

Notice

- Pressing and holding down the ESP OFF switch for 3 seconds turns on the ESP OFF indicator and the AEBS OFF indicator at the same time, and the ESP function and the AEBS function are deactivated.

Phenomenon that occurs when the ESP is activated

If the ESP is activated due to tight cornering, the ESP controls each wheel, so you can feel that the braking is applied to the relevant wheel, and vibrations on the brake pedal and noises may occur due to a change in the hydraulic pressure inside the system.

Also, the engine RPM may not increase due to the engine output control function if you depress the accelerator pedal.

When it is necessary to deactivate the ESP function

If the left and right driving wheels are slipping on a snowy road or an icy road continuously, the ESP function is activated to control the engine driving force. Accordingly, the engine RPM cannot be increased even if you depress the accelerator pedal, disabling you to drive the vehicle.

In such case, deactivate the ESP function to restore the engine driving force so that you can drive the vehicle.

- To deactivate the ESP function, press and hold down the ESP OFF switch (for 3 seconds or more).

The ESP OFF indicator on the instrument cluster turns on and the ESP function is deactivated.

- Pressing the ESP OFF switch again activates the ESP function.



Warning

- While the ESP is operating, do not press the ESP OFF switch. If you deactivate the ESP function by pressing the ESP OFF switch while suddenly accelerating or making a sharp turn, the vehicle may slip suddenly, causing a very dangerous situation. To deactivate the ESP function, be sure to press the ESP OFF switch only when you drive the vehicle on a straight flat road at a fixed speed.

Notice

A vehicle equipped with the ESP includes various auxiliary functions for improving the driving safety of the vehicle. The typical functions are as follows.

- BAS (Brake Assist System)

The BAS function detects a sudden braking situation and increase the brake pressure for a driver with leg strength who cannot apply sudden braking in a sudden braking situation.

- ARP (Active Roll-over Protection)

The ARP is an auxiliary safety function that helps the vehicle to maintain normal stability prior to the ESP when the driving status of the vehicle is highly unstable.

Caution

- The ESP is just a driving safety assist system of the vehicle and it cannot control the vehicle beyond its physical limitation. Do not rely too much on this system and be sure to drive safely.
- The activation of the ESP (the ESP indicator blinks) indicates that the vehicle is highly unstable. In such case, reduce the vehicle speed and drive the vehicle safely.
- The ESP is not activated when reversing the vehicle.
- Do not drive the vehicle immediately after starting the engine. When you drive the vehicle within 2 seconds after starting the engine, the self-diagnosis function of the ESP is not carried out and the ESP is activated in early stage while driving so that symptoms such as the ESP warning light turning on, warning buzzer and the generation of braking force on each wheel may occur.
- When the ARP function is activated, the braking of the engine and each wheel is controlled more powerfully in comparison to normal ESP operation, so the vehicle speed may decrease rapidly or strong braking force on each wheel is created, making the steering status unstable.
- When the ESP operates, vibrations and noises may occur on the brake pedal and other relevant devices due to a change in the hydraulic pressure inside the device.
- A vehicle equipped with the ESP may have slight vibrations while the self-diagnosis function is being carried out for the system, but this is a normal phenomenon.

Hill Descent Control (HDC)*

HDC is the system that decelerates the vehicle automatically to allow the driver to drive the vehicle at a low speed without depressing the brake pedal when the driver intends to drive the vehicle on a steep road at a low speed.

The variable type HDC applied to this vehicle operates flexibly in the range between 5 km/h and 30 km/h according to the vehicle environments (operation status of brake and accelerator pedal).

Warning

- Do not use the HDC function on a normal road. The HDC function is for driving on a downhill road, and using it on a normal road may cause a collision with a following vehicle.

Activating/deactivating the HDC function

- Pressing the HDC switch turns on the green HDC indicator on the instrument cluster and the HDC is in ready status.
- Pressing the HDC switch again turns off the HDC indicator and deactivates the HDC function.



HDC indicator/warning light



- Green indicator turns on: HDC in ready status
- Green indicator blinks: The HDC is operating.
- Red warning light turns on: The HDC system is overheated and abnormal.



Caution

- **When the red warning light turns on, the HDC function is not activated.**
- **When the red HDC indicator turns on, it indicates that the HDC system is overheated or abnormal. If the red HDC indicator stays on after the HDC-related device has been cooled down properly, have your vehicle checked and serviced at a KG Mobility authorized service center.**

HDC activation conditions

- When the HDC function is activated (green HDC indicator turns on)
- Within a certain degree of slope or higher and the operating speed range (approximately 5 km/h ~ 70 km/h)
- When the ESP function (including the BAS function) is not activated

HDC deactivation conditions

- When the HDC function is deactivated (green HDC indicator turns off)
- Degree of slope below the HDC activation condition
- When the vehicle speed is less than 5 km/h or more than 70 km/h
- When the HDC system is abnormal
- When the HDC system is overheated

Notice

- **While the HDC function is being activated, the driver can accelerate or decelerate the vehicle to the desired speed (approximately 5~30 km/h) for driving by depressing the brake pedal or the accelerator pedal. However, if the vehicle speed is less than 2 km/h or more than 70 km/h, the HDC function is deactivated.**

HDC operation

If the conditions for activating the HDC are met, the HDC is activated and the green HDC indicator on the instrument cluster blinks. If the vehicle speed becomes less than 2 km/h or more than 70 km/h or the sloping road becomes gentle while the HDC function is being activated, the HDC operation stops.

While the HDC function is operating, strong operating sounds and vibrations occur on the brake and this is normal according to the HDC operation.



Caution

- **The HDC function is for off-road driving on a steep downhill road.**
- **If the HDC function is used frequently, the brake system or the ESP may not operate normally.**
- **Avoid using the HDC function when driving on a normal road. If you drive the vehicle with the HDC ready status on a flat road, the HDC function may be activated when you make a tight cornering or pass through a speed bump.**
- **When the HDC is activated, vibrations and noises occur on the brake pedal and other relevant devices due to a change in the hydraulic pressure inside the device. This is a normal phenomenon according to the activation of the HDC.**

Manual parking brake



To operate manual parking brake

- 1 Park your vehicle to a level and safe ground.
- 2 Pull the manual parking brake lever.
The parking brake warning lamp lights up on the instrument cluster indicating that the parking brake is applied.

To release manual parking brake

- 1 Depress the brake pedal.
- 2 Press the Lock release button to lower the lever while pulling up the manual parking brake lever slightly.
The parking brake warning lamp goes off on the instrument cluster indicating that the parking brake is released.

Brake warning light

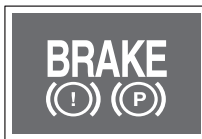

The warning lamp comes on when:

- Parking brake applied normally
- Brake fluid level low
- When driving with the parking brake applied (vehicle speed over 10 km/h for more than 2 seconds), the warning lamp flashes and a beep sounds. When this happens, stop the vehicle immediately and release the parking brake.

! Caution

- **Before driving off, be sure to check that the parking brake or low fluid level warning light is turned off.**
- **Always release the parking brake before starting. Driving with parking brake applied could damage the brake system.**

! Caution

- When using the parking brake to stop the vehicle, move the shift lever to the P (park) or N (neutral) position for your safety.
- Repeated use of the parking brake for an extended period of time may cause the parking brake cable to be stretched and the parking brake performance to deteriorate. Therefore, the parking cable should be checked periodically and adjusted if necessary.
- If the brake warning light doesn't go off after releasing the parking brake, have the brake system checked by a KG Mobility Dealer or KG Mobility Authorized Service Center.
- Do not attempt to replace the parking brake by placing the shift selector in the P (park) position. When parking/stopping the vehicle, always apply the parking brake firmly.
- When you park the vehicle with the shift lever in the N (neutral) position, turn the ignition off and move the shift lever to the N (neutral) position while pressing the shift lever lock release button.
- When parking/stopping the vehicle, always place the shift lever to the P (park) position. Otherwise, the vehicle can be rolled away according to the external impact or road condition.

Brake warning light

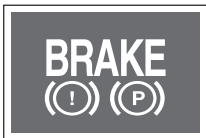

The warning light turns on in any of the following situations.

- When the parking brake is operating normally
- When the brake fluid is insufficient
- If you drive the vehicle without releasing the parking brake, the brake warning light blinks and the buzzer sounds to warn the driver when the vehicle speed exceeds 10 km/h for more than 2 seconds. When this happens, stop the vehicle immediately and release the parking brake.

Caution

- If the temperature drops below zero, such as during winter, the parking brake may not be released due to freezing of the parking brake related equipment.
- If you start the vehicle forcibly without releasing the frozen parking brake, the corresponding parts may be damaged. It may also cause noise.
- When you park the vehicle on a flat and safe place, not on a ramp in the sub-zero weather, place chocks under the wheels after parking the vehicle instead of using the parking brake.

Caution

- Before driving, be sure to check if the parking brake warning and the low oil warning light on the instrument cluster turn on.
- Be sure to release the parking brake before driving. Driving the vehicle with the parking brake applied may damage the brake system.
- When you use the parking brake for stopping while driving, move the gear shift lever to the P (parking) position or the N (neutral) position for safety.
- Do not use the P (parking) position of the gear shift lever instead of the parking brake. Be sure to apply the parking brake firmly when stopping or parking the vehicle.
- If you intend to place the gear shift lever in the N (neutral) and park the vehicle, turn off the engine with the gear shift lever in the P (parking) position, press the Gear shift lever unlock button and move it to the N (neutral) position.
- Be sure to place the gear shift lever in the P (parking) position when parking or stopping the vehicle. If the gear shift lever is not in the P (parking) position when parking or stopping, the vehicle may move due to an impact from the outside or along the road surface.

When parking the vehicle on an uphill road

- When you park the vehicle on an uphill road, park the vehicle with the steering wheel turned in the opposite direction from the curb.



When parking the vehicle on a downhill road

- When you park the vehicle on a downhill road, park the vehicle with the steering wheel turned in the direction toward the curb.



Double parking

To park the vehicle in front of another vehicle allowing the vehicle to be pushed or pulled, perform the following procedure:



- 1 Turn the ignition off with brake pedal depressed and gear selector lever in the P position.

Notice

- If the gear selector lever is in a position other than the P position, the vehicle power will not be turned off.

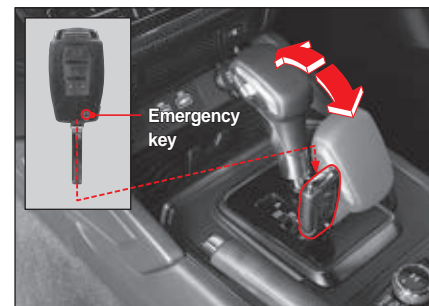

- 2 Shift the gear selector lever to the N position after pressing the lever lock release button with the brake pedal depressed.

! Caution

- In double parking mode, the vehicle may roll away. Therefore, the vehicle should be parked on a flat surface and taking the appropriate action, such as installing wheel chocks, is required.

Autonomous Emergency Braking (AEB)*

The AEB (Autonomous Emergency Braking) is an assist device that warns the driver of the risk of collision when a collision with the front vehicle or pedestrian is expected by the sensor of the front sensor module (front camera module and front radar).

This system informs the driver about the collision risk with the warning message and warning buzzer according to the level of collision risk. If this collision risk persists, this system controls the braking force to avoid collision or relieves the shock when a collision occurs, improving the safety of the driver and pedestrians.

1st collision alert → 2nd collision warning → 3rd emergency braking → Vehicle stop



Warning

- **AEBS is only an auxiliary system for helping the driver to secure safety in a dangerous situation and it does not avoid a collision situation automatically. The driver is responsible for the vehicle safety and control.**

Notice

- **The AEBS is set and Medium is set for the sensitivity of the forward collision warning as the factory default settings.**

AEB indicator/warning light

AEB OFF indicator



When the AEBS system and the ESP function are deactivated, the AEBS OFF indicator on the instrument cluster turns on.

Notice

- **Pressing and holding down the ESP OFF switch for 3 seconds turns on the ESP OFF indicator and the AEBS OFF indicator at the same time, and the ESP function and the AEBS function are deactivated.**

AEB indicator/warning light



The AEB indicator and warning light operate as follows depending on the AEB status.

- Blink: AEB is operating
- Turn on: AEB is abnormal

A warning message is displayed on the display of the instrument cluster as follows according to the AEBS status.

AEB is operating

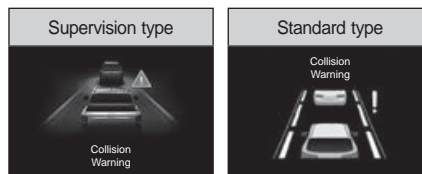

AEB is abnormal

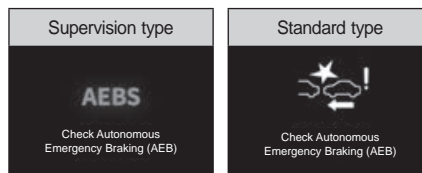

AEB is activated

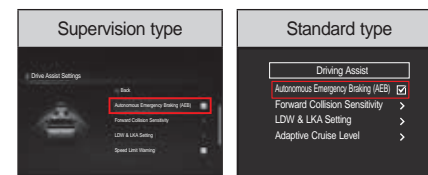

When you put a check mark on  (User Settings) → **Driving assist** → **AEB** from the instrument cluster, the function is activated and the AEBS OFF indicator on the instrument cluster turns off.

When you remove the check mark from the **AEB**, the function is deactivated and the AEBS OFF indicator turns on.

Caution

- **Activate or deactivate the AEB system before driving the vehicle or after stopping the vehicle at a safe place for safety.**
- **When the ESP function is deactivated, the AEB function is also deactivated automatically even if it was activated previously. The AEB function can also be activated from the User Settings menu on the instrument cluster.**

Setting the sensitivity of the forward collision warning



You can change the setting from  (User Settings) → **Driving assist** → **Forward Collision Sensitivity** on the instrument cluster.





- If **Fast** is set, the AEB warning is issued fast.
- If the AEB warning is too fast, set it to **Medium** or **Slow**.

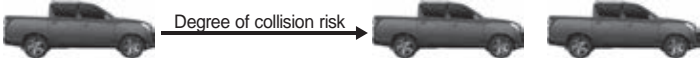

Caution

- Even if **Fast** is set for the sensitivity of the AEB warning, you may feel it is slow when a front vehicle applies a sudden braking.

AEBS operation

	Collision alert (1st warning)	Collision alert (2nd warning)	Emergency braking (3rd warning)	Vehicle stop
Classification				
Display window of the instrument cluster				
Warning buzzer	Sounds 7 beeps for 1 second			-
Vehicle control	-	-	Full brake control before collision.	Maintain the braking force for approximately 2 seconds after the vehicle stops.



Warning

- The AEB is an auxiliary system that helps the driver to secure safety in a dangerous situation and it does not guarantee safety.
- The AEB does not recognize all urgent and dangerous situations.
- Do not attempt dangerous driving for activating the AEB.
- The AEB does not avoid a collision situation automatically. The driver is responsible for the vehicle safety and control.
- Always secure safe braking distance and depress the brake pedal to reduce the vehicle speed if necessary.
- The AEB is activated according to the distance from a front vehicle or a pedestrian, relative speed and the driver's response.
- The AEB detects the driving situation through the front sensor module (front camera module and front radar). If the driving situation is not covered by the front camera, the performance of the system may deteriorate.

Activation conditions

When the following conditions are met after the AEB is activated, the system operates normally.

- When the AEB is activated
- When the Electronic stability control system (ESP) is activated
- When the Front Camera Module (FCM) recognizes a vehicle and a pedestrian at the front normally
- When the vehicle speed is between 8 km/h and 60 km/h

Notice

- The AEB is ready to operate in preparation of an urgent (dangerous) situation and when the driver depresses the brake pedal, this auxiliary system responds promptly.
- When the AEB is activated, it supplements the optimal braking force required for decelerating the vehicle.
- If the urgent (dangerous) situation is cleared, the AEB control stops.
- The 1st warning is activated up to the vehicle speed of 180 km/h.

Deactivation conditions

When the following conditions are met after the AEB is activated, the system is deactivated and the AEB does not operate.

- When the AEB is deactivated
- When the Electronic stability control system (ESC) is deactivated
- When the vehicle speed exceeds 60 km/h
- When the steering wheel is operated
- When the gear shift lever is placed in the P (parking) or the R (reverse) position
- When the accelerator pedal is depressed

The AEB cannot detect a vehicle properly:

- on a sharply curved section or a steeply sloping road
- when the vehicle wobbles significantly
- when the tail lights of a front vehicle are asymmetrical or are not turned on at night
- when the rear side of a front vehicle is asymmetrical
- when a vehicle cuts in suddenly
- An animal, an object or a vehicle driving, or when the vehicle is driving in the opposite direction
- An approaching vehicle or a vehicle that is reversing
- An odd-shaped front vehicle
- When there is rapid change of illumination (tunnel entrance, etc.)
- When the shape is not visible due to shade right below an overpass

- There is poor visibility due to bad weather such as snow, rain and fog
- When the moisture formed on the glass of the windshield is not removed completely
- When the reflection from an object placed on the dashboard panel obstructs the recognition of the Front Camera Module (FCM)
- When there is a narrow object such as a motor cycle or a bicycle in front of the vehicle
- A vehicle moving or stopping perpendicularly to the driving direction at an intersection



Caution

- **The driver's attention is required since the AEB may not respond normally or the system may malfunction when it is difficult to detect a vehicle.**

Curved road



On a curved road, a front vehicle on the same lane cannot be detected and the AEB performance is reduced so that unnecessary warning or braking is applied or the system may not operate.

Check the front road and driving conditions on a curved road and adjust the vehicle speed directly by depressing the brake pedal if necessary.

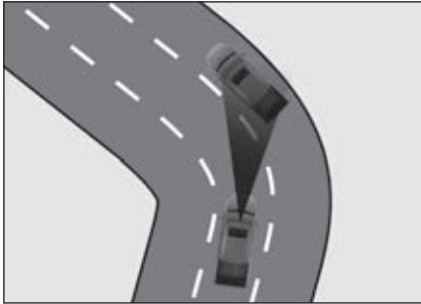

A vehicle on another lane may be detected, affecting the speed. Check the front road and driving conditions and adjust the vehicle speed directly by depressing the brake pedal if necessary.

In such case, you can prevent unnecessary deceleration by depressing the accelerator pedal.

Sloping road

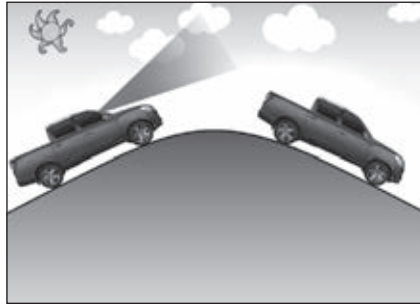

On a uphill road or a downhill road, a vehicle on the same lane cannot be detected and the AEBS performance is lowered so that unnecessary warning or braking is applied or the system may not operate.

Also, a front vehicle is detected suddenly and the warning and braking may be applied.

Check the front road and driving conditions on a uphill road or a downhill road and adjust the vehicle speed directly by depressing the brake pedal if necessary.

When changing the lane

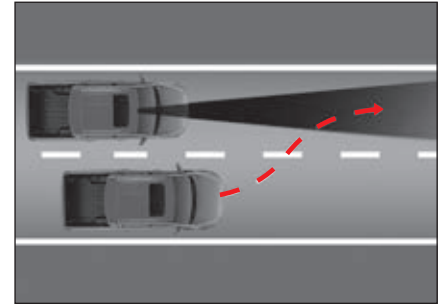

When a vehicle on the next lane changes the lane to the same lane, the vehicle may not be detected until it enters the detection range of the Front Camera Module (FCM).

Always pay attention since a vehicle that cuts in suddenly may be detected late.

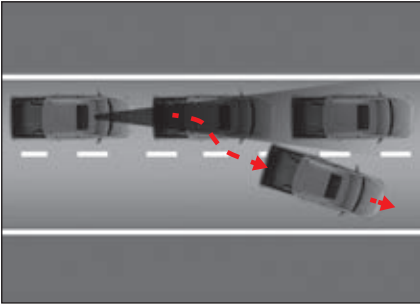

Caution should be taken that if there is a vehicle stopped in front of the vehicle ahead and the vehicle ahead moves out of the lane while your vehicle has been decelerated due to the AEB operation, the vehicle stopped at the front is not selected as the control target, causing a collision risk.

Recognition of a vehicle ahead

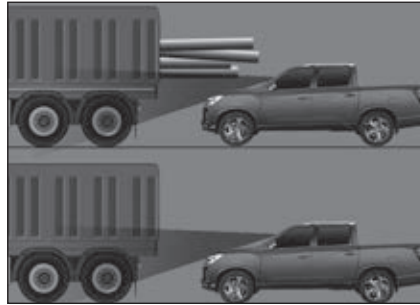

Caution should be taken that a tall vehicle or a vehicle with cargo sticking out the back of the vehicle may cause a dangerous situation.

The AEB cannot detect a pedestrian

- who is not standing normally
- whose body is hidden or who does not walk upright
- who moves fast
- who cuts in suddenly
- who wears clothes in a color similar to the background
- when the surrounding illumination intensity is too high or too low
- at night or when the surrounding area is dark
- if there is a structure similar to a person
- if he/she is short
- whose behavior is unstable
- When there is a situation that disables the AEB to detect a pedestrian by environments
- when there are many people gathered together
- When there is an object (cart, bicycle, two-wheeler, suitcase, stroller, etc) pushed by the pedestrian



Warning

- The AEB is not activated in all situations. Therefore, do not test the AEB targeting a person or an object. Doing so may cause serious injury or death.
- When you start the vehicle, the AEB is always activated automatically. If you need to deactivate the function, use the User Settings menu on the instrument cluster.
- If the AEB is activated and you apply a sudden braking, occupants in the vehicle may face danger. Therefore, always pay attention just in case.
- If the front camera is stained with foreign materials, its detection function is lowered and the AEB is deactivated temporarily. Always keep the camera clean.
- If the front camera has deviated from its normal position due to a shock, the system may not operate normally even if the warning light does not turn on or the warning message is not displayed on the instrument cluster.
- At night, the vehicle and pedestrian detection performance may be lowered since the lighting condition is poor in comparison to daytime.
- If frost forms on the windshield during winter, the front camera may not detect normally. Be sure to remove the frost.

- Failure to do so may result in unnecessary warning and braking, and the warning and braking may not be applied due to the detection limitation of the sensor.
- If a vehicle ahead applies a sudden braking, proper brake application may not be carried out, causing a collision. Always pay attention in preparation for a dangerous situation.
- If you tow another vehicle or a trailer, cancel the AEB setting. Applying braking while towing may lower the safety of the vehicle.
- When you load the vehicle on a truck, a train or a ship that transports a vehicle, deactivate the AEB. The system may be activated according to the contact condition in the loading process.



Caution

- The AEB may be deactivated temporarily by a strong electromagnetic wave.
- Do not tint the Front Camera Module (FCM) detection area. Doing so may cause the relevant system to malfunction or not to operate.

Part prohibited for tinting (FCM detection area)

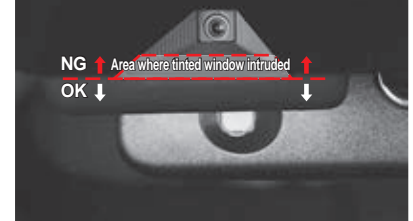

Rear and side warning system*

The rear and side warning system is an auxiliary system that detects and informs the blind spot area that cannot be detected by the driver using the detection sensor located inside of both edges of the rear bumper.

- The rear and side warning system includes the following warning systems.
 - Blind spot-detection warning (BSW) system
 - Blind spot collision assist (BSA) system
 - Lane change warning (LCW) system
 - Rear cross traffic warning (RCTW) system
 - Rear cross traffic assist (RCTA) system
 - Safety exit warning (SEW) system

Display of rear and side warning system activation



When the outside rearview mirror warning light blinks twice with the START/STOP switch in the ON status or while the engine is running, it indicates that the rear and side warning system is operating normally.

Note

- You can change the BSW system settings in User Settings in the instrument cluster.

Warning

- The rear and side warning system is an auxiliary system that helps the driver to drive the vehicle safely. Avoid depending on the rear and side warning system in any case and drive the vehicle while checking the road condition.

Caution

- Always keep the rear bumper clean. The sensor that detects the rear and both sides of the vehicle is installed inside of both edges of the rear bumper. If the rear bumper is stained with foreign materials, the sensors may not function normally
- When the rear bumper is replaced, painted or repaired, the system operation performance may be lowered.
- The detection sensors of the system may not operate depending on the surrounding environment. Drive the vehicle while checking the road condition directly for an emergency situation.
- Failure to do so may cause the system to malfunction due to a strong electromagnetic wave.

Activating/deactivating the warning buzzer of the rear and side warning system

• Supervision type

Go to Instrument **Cluster Settings** → **Sound** → **BSW System Audible Alert** → **Enable BSW Audible Alert, RCTW Audible Alert and SEW Audible Alert** in  (User Settings) in the instrument cluster and tick the corresponding boxes.

• Standard type

Go to **Sound** → **BSW System Audible Alert** → **Enable BSW System Audible Alert, RCTW Audible Alert and SEW Audible Alert** in  (User Settings) in the instrument cluster and tick the corresponding boxes.

Notice

- “Rear and side warning system ON” or “Rear and side warning system OFF” message is displayed for approximately 2 seconds on top of the display window of the instrument cluster according to the activation and deactivation of the rear and side warning system. Also, the outside rearview mirror warning light blinks twice.
- If you do not use the rear and side warning system, be sure to deactivate the system.
- If you wish to connect a trailer, be sure to deactivate the system for preventing a system malfunction.

Warning level of the rear and side warning system

When a blind spot on the rear left or right side of the vehicle or a vehicle approaching at a fast speed is detected with the blind spot detection and lane change assist system function activated and the driving speed is approximately 30 km/h or more, the rear and side warning system is activated.

1st warning

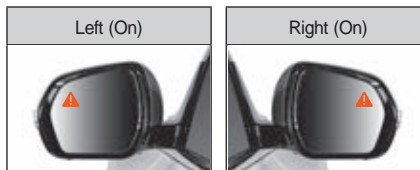

When a vehicle in the rear and side warning area of the vehicle is detected, the yellow warning light indicator on the outside rearview mirror turns on.

When the relevant vehicle deviates the warning area during the operation of the 1st warning, the warning operation is stopped according to the driving condition after a certain period of time.

2nd warning

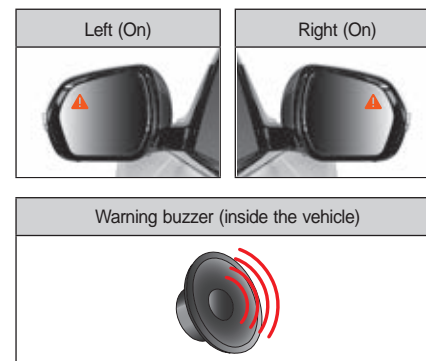

When you operate the turn signal with the 1st warning (Yellow warning light on the outside rearview mirror turns on), the 2nd warning is operated as follows.

- Yellow warning light on the outside rearview mirror blinks
- Warning buzzer sounds inside the vehicle.

When you return the turn signal switch to its original position (OFF status) during the operation of the 2nd warning, the second warning operation is stopped.

When the rear and side warning system is abnormal

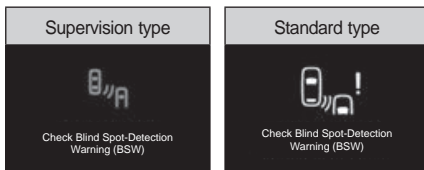

When the rear and side warning system is abnormal, a warning message is displayed on the display of the instrument cluster.

Caution

- When the warning message on the faulty RCTW is displayed, all the RCTW relevant functions are disabled.
- If the warning message persists, have your vehicle checked and serviced at a KG Mobility authorized service center.



If the sensor cannot detect the rear and both side areas of the vehicle normally with the rear and side warning system activated, the message is displayed on the display of the instrument cluster.

- When there is a foreign material on the outside and inside of the rear bumper
- When equipment such as a trailer is installed on the rear of the vehicle
- When driving on open area where no objects around road continuously (e.g., desert, meadow)
- When there is a heavy snow or a heavy rain
- When the width of the road is wide

Blind Spot Warning (BSW) system

The BSW system detects a vehicle approaching the blind spot on the rear and both sides of the vehicle and informs it to the driver by turning on the outside rearview mirror warning light.

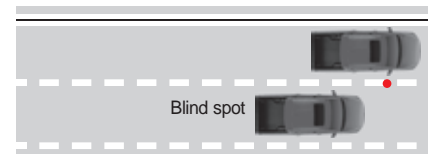

Activation conditions

The BSW system is activated when the following conditions are met.

- When the rear and side warning system is activated
- When the vehicle speed is more than 30 km/h and less than 255 km/h
- When a vehicle is present in the blind spot detection area

Warning

- The Blind Spot Warning (BSW) system can only give a warning in a limited area and the warning function may not operate for a vehicle approaching the rear blind spot depending on the surrounding situation and driving conditions.

Lane Change Warning (LCW) system

The LCW (Lane Change Warning) system is designed to alert the driver by flashing the outside rearview mirror and sounding the beep when a fast approaching vehicle is detected from the rear side of the driver's vehicle.

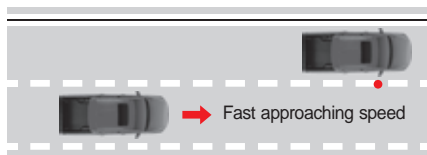

Operating conditions

The LCW system activates the warning system when the following conditions are met:

- BSW system is activated.
- Vehicle speed is between 30km/h and 255km/h.
- When a vehicle approaching at a high speed is in the detection area.
- Driver's vehicle is driving on a straight road.

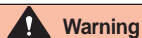

Warning

- **This system is an aid to ensure the driver convenience. If you depend on this system, it may cause accidents. Always check the surroundings with a side mirror when changing lanes.**

BSA System

The BSA (Blind Spot-collision Assist) system is a system that, when the driver's vehicle unintentionally closes to the lane, directs the vehicle through one-sided braking to the center of the lane when a collision with the vehicle in the rear blind spot is expected, and notifies the driver by illuminating the warning light in the outside rearview mirror.

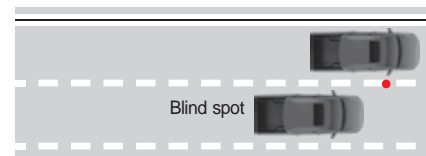

4

Operating conditions

The blind spot collision assist (BSA) system issues a warning when:

- Blind spot collision assist (BSA) is set.
- Vehicle speed is between 60km/h and 140km/h.
- Vehicle is driving on a road where both lanes are recognized normally with no brake applied. (including AEB and ACC)

BSA is deactivated when:

- Driver turns the steering wheel sharply.
- Part of vehicle has already entered the next lane.
- Brake pedal is depressed.
- The brake-related function is working (such as ACC, AEB, ESP and ABS)

Caution

- After changing lanes, you must move to the center of the lane. The system may not work if the vehicle continues to drive close to the lane.

Warning

- The braking control may not work depending on the electronic stability control (ESP).
- When the electronic stability control (ESP) warning light comes on, the braking control does not work.
- When the electronic stability control (ESP) performs another function, the braking control does not work.

RCTW System

The RCTW (Rear Cross Traffic Warning) system is a system that, when a vehicle is detected approaching from the rear left/right side during reversing the vehicle, displays a warning message in the instrument panel display window, sounds a audible alert and illuminates the warning lamp in the outside rearview mirrors to inform the driver.

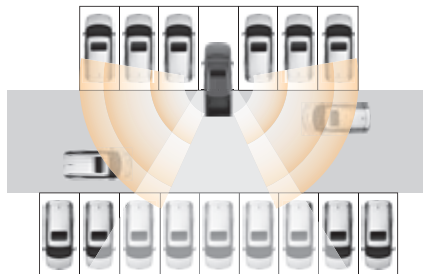

Activating / deactivating RCTW system

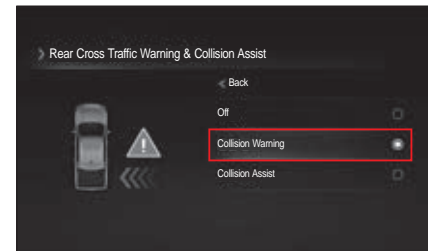

- Go to **Driving Assist Setting** → **Blind-Spot Collision Assist** → **Blind Spot Detection & Collision Assist** → **Enable Collision Warning** in  (User Settings) in the instrument cluster and tick the check box.

Activation conditions

- RCTW system is activated
- If the gear shift lever is placed in the R (reverse) position
- When the vehicle speed is less than 10km/h
- If a vehicle exists within the RCTW range and the speed of the approaching vehicle is 24 km/h or less

If an approaching vehicle is detected, the approach message from the relevant side is on the display of the instrument cluster.

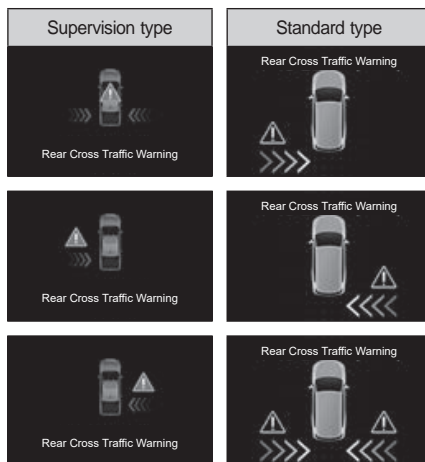

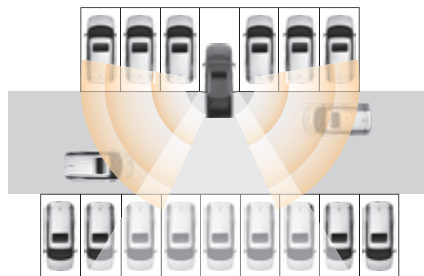

RCTA System

The RCTA (Rear Cross Traffic-collision Assist) system is an assistive device that outputs a warning message and a buzzer to inform the driver of risk of collision due to a vehicle approaching to your side when backing up and help collision avoidance or mitigate damage by applying brake assist.

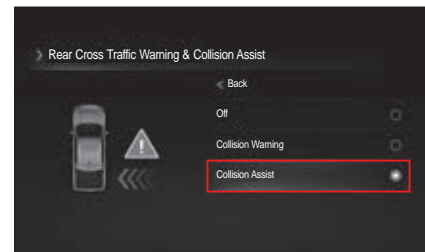

Activating / deactivating RCTA system



- Go to **Driving Assist Setting** → **Blind-Spot Collision Assist** → **Blind Spot Detection & Collision Assist** → **Enable Collision Assist** in  (User Settings) in the instrument cluster and tick the check box.

Operating conditions:

- Shift lever in R (reverse) position
- Vehicle speed of below 8 km/h
- Vehicle in warning area with approaching speed of less than 24 km/h

If the risk of collision is detected due to an approaching vehicle during operation of the RCTA system, emergency braking (braking assist) is performed.

- The braking assist does not restart for about 10 seconds after it operates.

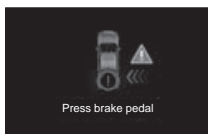
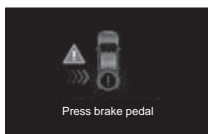
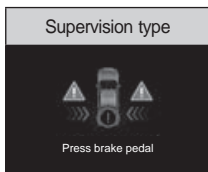

Note

- **This system may not function depending on the operation of ESC system.**
 - **When ESC warning lamp light up**
 - **When ESC system is operating**

Cases where RCTA system not work

In any of the following cases, the RCTA may not operate.

- If the target vehicle is out of the RCTA detection area
- If the target vehicle is right behind
- If the target vehicle is moving in the same direction
- If the speed of the target vehicle is fast
- If the speed of the target vehicle decreases suddenly
- If the detection sensor is covered with an obstacle

Cases where the RCTA system malfunctions

In any of the following cases, the system may malfunction, so the driver's attention is necessary.

- If the rear bumper is stained with foreign materials (rain, snow, dust, sticker, etc)
- When equipment such as a trailer is installed on the rear of the vehicle
- When the rear bumper is damaged or the vehicle body is distorted
- Sharp curve, tollgate entrance and exit section
- Tire pressure imbalance and excessive loading
- Bad (heavy snow, heavy rain) weather
- When there is a fixed object (median strips, guardrails, noise barriers) on the road or a construction section
- When a large vehicle or a small motor cycle (bicycle) is driving at a close range
- When your vehicle is passing by heavy-duty trailer
- When you accelerate the vehicle with an opposite vehicle together at the same time
- When the speed of a vehicle behind is very fast (passing)
- When you change the lane
- Steep uphill road, downhill road or a road condition where the height of lanes is different
- When an opposite vehicle is driving very closely to the rear side of the vehicle

- When a vehicle behind driving closely passes
- When the area near the sensor is covered with a vehicle, a column or a wall in the parking lot
- A vehicle that moves in the same direction when reversing the vehicle
- A small moving object such as a person, a shopping cart or a stroller
- When parking conditions are complicated (diagonal parking, near the ramp, obstacle, etc.)
- A vehicle with very low vehicle body
- A narrow road densely covered with trees or grass
- When the width of the road is very wide
- When the road surface is wet
- When the sensor detection area is changed due to a rear collision

Warning

- **The Rear Cross Traffic Warning (RCTW) system does not give a warning for an article adjacent to the vehicle and the warning function may not be activated for a vehicle approaching fast in the rear.**
- **The BSW and RCTW are assistive devices for the driver, not the safety devices. If you depend on these systems, it may cause accidents. The driver is responsible for safe driving of the vehicle by maneuvering the brake pedal. Depending on the surrounding environment and driving conditions, the warning and control functions of the system may not operate or may operate unnecessarily. Always check the surroundings while driving.**

SEW System

The SEW (Safety Exit Warning) system is an assistive device that warns the driver and passengers about the risk of an accident by displaying a warning message on the instrument panel along with a buzzer when there is a vehicle approaching from the rear side when the driver or passenger is getting off the vehicle.

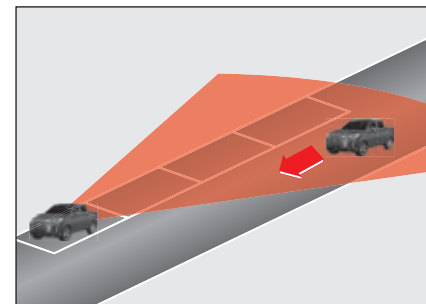

Caution

- **The exit assist function operates for about 10 minutes after the ignition switch is turned off. After about 10 minutes, the exit assist function does not work to prevent battery drain.**
- **When you lock the door with a smart key, the exit assist function will not work immediately.**

Activating / deactivating SEW system

- Go to **Driving Assist Setting** → **Blind-Spot Collision Assist** → **Enable SEW** in  (User Settings) in the instrument cluster and tick the check box.

Operating conditions:

- Shift lever in P (park) or N (neutral) position
- Vehicle parked
- You are about to open the door to leave the vehicle when a vehicle is approaching from the rear side

If a vehicle approaching from the rear side is detected, a warning message is displayed on the instrument panel display along with a buzzer to inform the driver and the passenger.

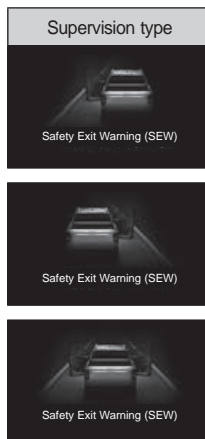

LDW (Lane Departure Warning)*

The LDW is a driving assist system that its Front Camera Module (FCM) detects the lanes ahead and issues a warning message and sounds the warning buzzer to help the driver to drive the vehicle while maintaining the vehicle on the line properly when the vehicle deviates from the lane with the turn signal not activated.

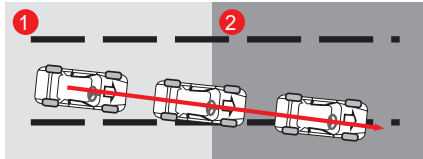

- 1 Detect the deviation of the lane with the turn signal not activated
- 2 Display a warning message and sound the warning buzzer

Warning

- The LDW prevents the lane departure, gives a warning to the driver and sounds the warning buzzer. Never depend on the lane departure warning system in any case and drive while checking the road condition.

To activate / deactivate lane departure warning (LDW)



- Go to Driving Assist Setting → Forward Safety Assist → Enable LKAS in  (User Settings) in the instrument cluster and tick the check box of Lane Departure Warning (LDW).

Activating/deactivating the LDW

With the START/STOP switch in the ON status, press the lane departure warning system switch to activate the system. When the system is activated, the lane departure warning indicator on the instrument cluster turns on.

Pressing the switch again with the lane departure warning system activated deactivates the system and the lane departure warning indicator turns off.

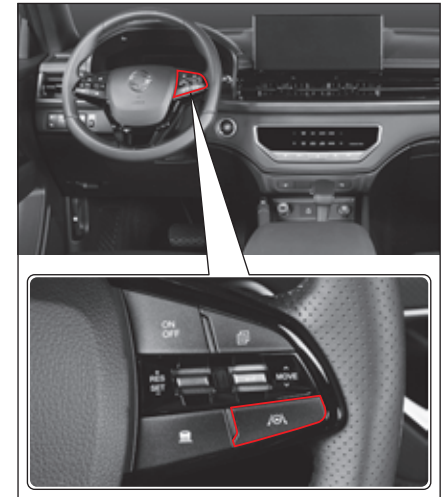

4

LDW ON indicator



When the lane departure warning system is activated, the indicator on the instrument cluster turns on.

- White indicator turns on: The lane departure warning system is in ready status (the vehicle speed is below a prescribed speed or the lane is not recognized).
- Green indicator turns on: The lane departure warning system is operating normally.
- Yellow warning light turns on/blinks: When the LDW is abnormal

Activation conditions

If the following conditions are met, the LDW is activated.

- When the LDW is set
- When the vehicle speed is between 40 kph and 175 kph
- When the front camera recognizes the left and right lanes
- A straight road or gently curved road

☞ Refer to "Lane departure indicator/warning light**" (p.4-45)

Notice

- **Entry and release conditions depending on vehicle speed**
 - **Entry conditions: 40 kph or above, 175 kph or less**
 - **Release conditions: 35 kph or less, 185 kph or above**



Warning

- **Be sure to hold the steering wheel while driving.**
- **The driver is responsible for operating the steering wheel to ensure the safe driving of the vehicle.**
- **Do not steer the vehicle rapidly when the lane departure warning system is activated.**
- **The lane departure warning system only gives a warning and sounds the warning buzzer. Therefore, the driver should keep the vehicle in the lane by steering the vehicle carefully while driving.**
- **The lane departure warning system may be deactivated, may not operate or may operate unnecessarily according to road condition and surrounding environment. Therefore, pay attention while driving.**
- **Do not attempt dangerous driving for activating the lane departure warning system.**



Caution

- Do not tint or attach a sticker or an accessory to the Front Camera Module (FCM) detection area. Doing so may cause the relevant system to malfunction or not to operate normally.
- The lane departure warning system recognizes a lane using the camera, and if the lane is not recognized properly, the system may be deactivated or may operate unnecessarily, so be careful when using the system.
- If the lane is not recognized properly, be sure to check the conditions for driver's attention.
- Do not detach any component from the LDW or apply an impact to the LDW.
- Do not place a reflecting object (white paper or mirror) on the dashboard. Doing so may cause the system to malfunction due to the reflection of light.
- The warning buzzer of the LDW may not be heard due to the loud sound from the audio system.

Message on instrument cluster

Both lane lines are detected

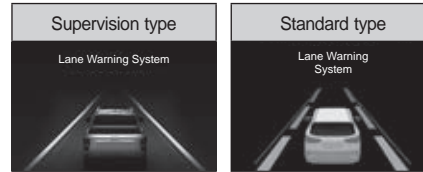

When both lane lines are detected while the vehicle is being driven at 40 km/h or more, both the lane markers on the display turns green.

Only one lane line is detected

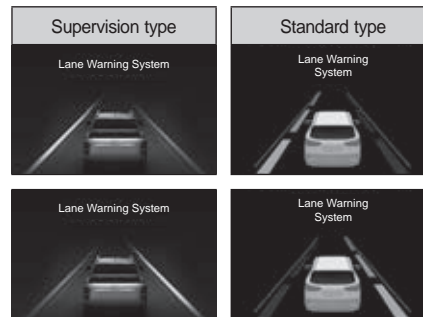

When only one lane line is detected while the vehicle is being driven at 40 km/h or more, the corresponding lane marker on the display turns green.

Driving at low speed or both lane lines are not detected

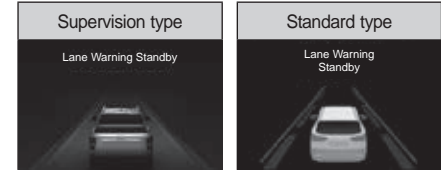

When the vehicle is driven at less than 40 kph (low speed conditions) or both lane lines are not detected, the lane marker is shaded.

Approaching a lane line without a turn signal

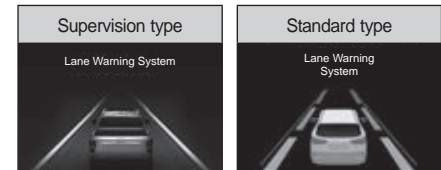

It is activated when the turn signal is not activated or the vehicle deviates from center of the lane.

LDW cannot operate

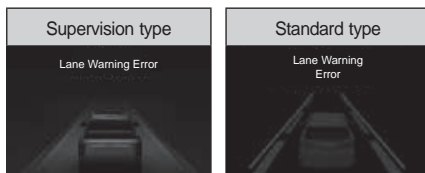

This message is displayed when the LDW is unavailable.

System check in progress



This message is displayed when the LDW is being checked.

System OFF



This message is displayed when the LDW is deactivated.

Cases that the system is not activated

- When the turn signal and the hazard warning lamp are operated for changing the lane
- When both the left and right lanes are not recognized
- When the vehicle is driven on one side of the lane continuously without moving to the center of the lane after changing the lane
- If the steering wheel is operated suddenly for changing the lane (the system is not activated temporarily)
- When the Electronic stability control system (ESC) is activated
- When the vehicle is circling fast on a curved road
- When the vehicle speed is less than 35 kph and more than 180 kph
- When you need to change the lane rapidly
- When the width of the lane is too narrow or too wide so that the lane cannot be detected
- When there are 2 or more lane markings on the lane while driving (example: construction section)
- If the radius of a curved road is too small

- In case of a steep sloping road
- When the vehicle speed is reduced rapidly
- When the tinted part of the windshield covers a part of the Front Camera Module (FCM) detection range

Warning

- **Change the lane after operating the turn signal switch.**

Caution

- **Do not tint the Front Camera Module (FCM) detection area. Doing so may cause the relevant system to malfunction or not to operate.**

Part prohibited for tinting (FCM detection area)



Cases requiring the driver's attention

In any of the following cases, the system may not operate or may operate unnecessarily. Therefore, the driver's attention is necessary.

- If the lanes are not visible due to foreign substances (rain, snow, dust, puddle, wet road surface)
- If the color of lane markings and the road cannot be distinguished clearly
- If the lane markings are not clear or are damaged or two or more lane markings are present on one side
- If there are markings other than or similar to the lane marking near the lane
- If the lane markings are covered in the shade of median strips, guardrails, noise barriers, other structures or roadside trees
- If there are boundary structures such as sidewalk blocks
- If the lane is crowded due to the construction section or some lanes are replaced with structures
- When the lane suddenly disappears or is invisible on the intersection
- There is a section where the number of lanes increases or decreases or the lanes intersect complicatedly (tollgate entrance, road junction/merge section, etc)
- If the lane is too narrow or too wide
- If the distance from a vehicle ahead is extremely short or a vehicle ahead is driving while hiding the lane
- There is a marking for a crosswalk or road sign on the road surface
- If the visibility is poor due to bad weather such as fog, heavy rain or heavy snow
- If the visibility is poor so that the lane cannot be recognized
- When the brightness outside the vehicle changes rapidly such as the entering a tunnel
- When the light is weak or the head light of the vehicle is not used at night or in a tunnel section

- When you drive the vehicle on the bus-only lane or on the left or right lane of the bus-only lane
- On a sharply curved section or a steeply sloping road
- when the vehicle wobbles significantly
- When a reflecting object (white paper or mirror, etc.) is placed on the dashboard
- When the windshield or the front side of the camera lens is contaminated with dust
- When the moisture formed on the glass of the windshield is not removed completely
- When the temperature near the camera is very high due to direct sunlight
- When there is backlight in the moving direction of the vehicle
- When the sunlight, streetlight or the light from an incoming vehicle is reflected by water on the road surface
- When front camera is arbitrarily refitted (Be sure to visit our authorized service center to perform the calibration of the front camera. Otherwise, it may cause the camera to malfunction.)

Lane Keeping Assistance (LKA)*

The LKA (Lane Keeping Assist) is an assistive vehicle operation technology that detects vehicles up ahead using the FCM (Front Camera Module), and when the system detects that the vehicle is departing from the current lane without a lane change indication, the vehicle visually and audibly warns the driver through the LDW (Lane Departure Warning), and if the vehicle continues to depart from the lane, the vehicle maintains stays in the current lane by taking control using the EPS (Electronic Power Steering) system.

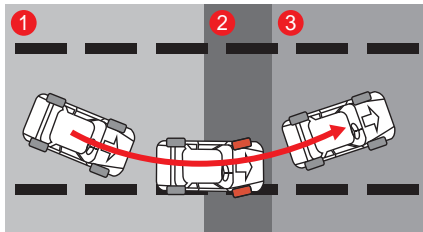



- 1 Lane departure without activation of turn signal lamp detected
- 2 Steering control by EPS as well as warning message and buzzer
- 3 The vehicle is steered toward the center of the lane.

Warning

- The LKA assists the driver with audible and visual warnings so that the vehicle does not move out of the driving lane unintentionally. Do not drive the vehicle in a dangerous or reckless manner relying on the LKA. Always drive safely paying attention to the road conditions.
- The LKA is an assistive device that precisely controls the steering wheel so that the vehicle does not leave the lane regardless of the intention of the driver.

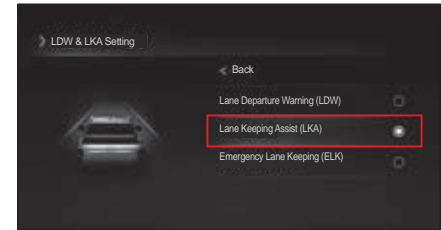
To activate / deactivate lane keeping assistance (LKA)



- Go to Driving Assist Setting → Forward Safety Assist → Enable LKAS in  (User Settings) in the instrument cluster and tick the check box of Lane Keeping Assist (LKA).

4

To enable / disable LKA

Press the LKA switch with the ignition switch turned on. If the system is activated, the LKA ON indicator lights up on the instrument cluster.

When the switch is pressed again with the LKA is in active, the system will be deactivated and the LKA ON indicator will go off.

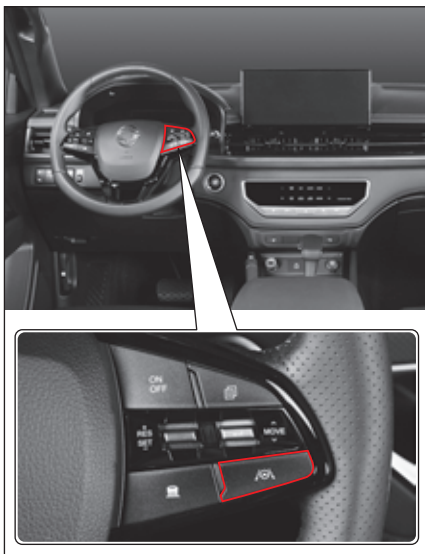

LKA ON indicator



This indicator light up on the instrument cluster when the LKA is activated.

- Indicator ON in white: System READY state (Vehicle speed below specified value or no lane detected)
- Indicator ON in green: LKA operates normally
- Indicator ON in yellow / flash: Faulty LKA system

Operating conditions

The LKA system is activated when:

- LKA is enabled
 - Vehicle travels at a speed between 40 kph and 175 kph
 - Front camera recognizes left/right lanes
 - Driving on a straight road or gentle curve
 - Turn signal is not activated
- ☞ Refer to "Lane departure indicator/warning light*" (p.4-45)

Notice

- **Entry and release conditions depending on vehicle speed**
 - Entry conditions: 40 kph or above, 175 kph or less
 - Release conditions: 35 kph or less, 180 kph or above



Warning

- Do not release your hands from the steering wheel while driving.
- The driver is responsible for safe driving of the vehicle by maneuvering the steering wheel.
- Do not steer the vehicle rapidly while the LKA is activated.
- The LKA does not always control the steering wheel automatically.

Warning

- The LKA is only a device to assist with the steering wheel operation, and the driver is entirely responsible for maintaining the lane with the steering wheel operation.
- The LKA may be deactivated, not work at all, or activated when it is not desired depending on the road conditions and surrounding environment.
- Never drive the vehicle in a dangerous or reckless manner to test the LKA.
- When replacing the steering wheel system-relevant parts, have the system checked and serviced at a KG Mobility Dealer or KG Mobility Authorized Service Center.

Caution

- Do not attach sticker, accessory, tinting films on the detection area of the FCM. This can cause malfunctions and abnormal operation of the related systems.
- The LDW recognizes the lanes by using the images from the cameras. Keep in mind that the LDW may be deactivated or activated when it is not desired if the lanes are not recognized successfully.
- Pay close attention especially when the LKA fails to detect the lane markings.

Caution

- Do not remove any part of the LDW or apply impact on it.
- Do not put any object with reflective surface (white paper, mirror, etc.) on the instrument panel. Reflected lights can cause system malfunction.
- You may not hear the audible alert (chime) if the sound from your audio source is too loud.
- If you drive without holding the steering wheel for too long, LKA will be turned off automatically after the hands off alert.
- Please note that when driving at high speed, the steering assist force of the lane keeping assist system may be reduced, which can cause the vehicle to leave the lane.
- The driver is responsible for operating the steering wheel.
- The driver can still steer the vehicle in the event of the faulty LKA.
- Please operate the steering wheel by hand without using the LKA when:
 - Weather is bad
 - Road condition is not good
 - Frequent steering wheel control is required
- You may feel that the steering wheel is heavy or light when the LKA is not operating.

Message on instrument cluster

Both lane lines are detected

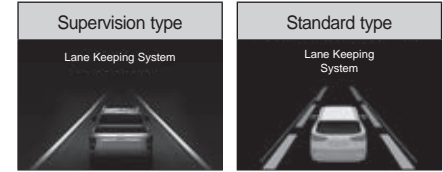

When both lane lines are detected while the vehicle is being driven at 40 km/h or more, both the lane markers on the display turns green.

Only one lane line is detected

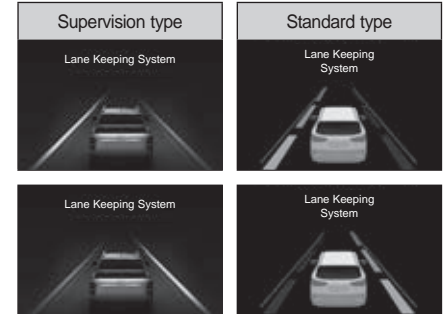

When only one lane line is detected while the vehicle is being driven at 40 km/h or more, the corresponding lane marker on the display turns green.

Driving at low speed or both lane lines are not detected

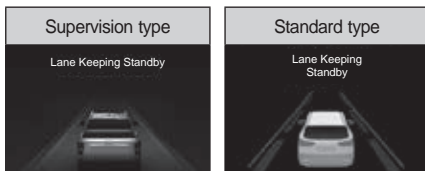

When the vehicle is driven at less than 40 kph (low speed conditions) or both lane lines are not detected, the lane marker is shaded.

Approaching a lane line without a turn signal

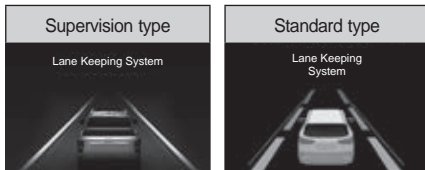

If your vehicle approach either side of the lane without turning on the corresponding turn signal lamp while the LKA is operating, the corresponding lane marker on the display will blink (green ↔ red).

LKA cannot operate

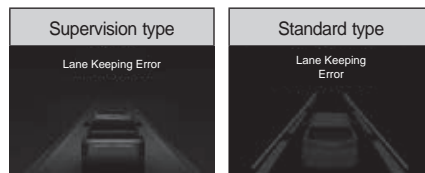

This message is displayed when the LKA is unavailable.

System check in progress

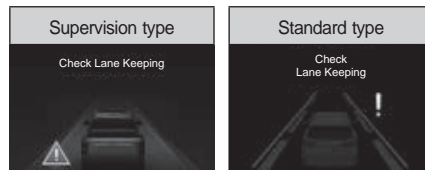

This message is displayed when the LKA is being checked.

System OFF



This message is displayed when the LKA is deactivated.

Cases that the system is not activated

- When the turn signal and the hazard warning lamp are operated for changing the lane
- When both the left and right lanes are not recognized
- When the vehicle is driven on one side of the lane continuously without moving to the center of the lane after changing the lane
- If the steering wheel is operated suddenly for changing the lane (the system is not activated temporarily)
- When the Electronic stability control system (ESC) is activated
- When the vehicle is circling fast on a curved road
- When the vehicle speed is less than 35 kph and more than 165 kph
- When you need to change the lane rapidly
- When the width of the lane is too narrow or too wide so that the lane cannot be detected
- When there are 2 or more lane markings on the lane while driving (example: construction section)
- If the radius of a curved road is too small

- In case of a steep sloping road
- When the vehicle speed is reduced rapidly
- When the tinted part of the windshield covers a part of the Front Camera Module (FCM) detection range

Warning

- **Change the lane after operating the turn signal switch.**

Caution

- **Do not tint the Front Camera Module (FCM) detection area. Doing so may cause the relevant system to malfunction or not to operate.**

Part prohibited for tinting (FCM detection area)

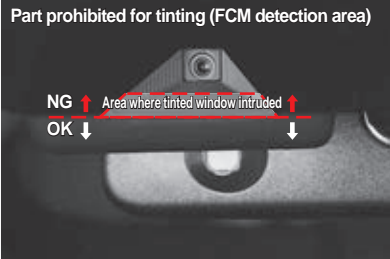

Cases requiring the driver's attention

In any of the following cases, the system may not operate or may operate unnecessarily. Therefore, the driver's attention is necessary.

- If the lanes are not visible due to foreign substances (rain, snow, dust, puddle, wet road surface)
- If the color of lane markings and the road cannot be distinguished clearly
- If the lane markings are not clear or are damaged or two or more lane markings are present on one side
- If there are markings other than or similar to the lane marking near the lane
- If the lane markings are covered in the shade of median strips, guardrails, noise barriers, other structures or roadside trees
- If there are boundary structures such as sidewalk blocks
- If the lane is crowded due to the construction section or some lanes are replaced with structures

- When the lane suddenly disappears or is invisible on the intersection
- There is a section where the number of lanes increases or decreases or the lanes intersect complicatedly (tollgate entrance, road junction/merge section, etc)
- If the lane is too narrow or too wide
- If the distance from a vehicle ahead is extremely short or a vehicle ahead is driving while hiding the lane
- There is a marking for a crosswalk or road sign on the road surface
- If the visibility is poor due to bad weather such as fog, heavy rain or heavy snow
- If the visibility is poor so that the lane cannot be recognized
- When the brightness outside the vehicle changes rapidly such as the entering a tunnel
- When the light is weak or the head light of the vehicle is not used at night or in a tunnel section
- When you drive the vehicle on the bus-only lane or on the left or right lane of the bus-only lane
- On a sharply curved section or a steeply sloping road
 - when the vehicle wobbles significantly
- When a reflecting object (white paper or mirror, etc.) is placed on the dashboard
- When the windshield or the front side of the camera lens is contaminated with dust
- When the moisture formed on the glass of the windshield is not removed completely
- When the temperature near the camera is very high due to direct sunlight
- When there is backlight in the moving direction of the vehicle
- When the sunlight, streetlight or the light from an incoming vehicle is reflected by water on the road surface
- When front camera is arbitrarily refitted (Be sure to visit our authorized service center to perform the calibration of the front camera. Otherwise, it may cause the camera to malfunction.)

ELK (Emergency Lane Keeping)*

RKA-ROADEDGE (Lane Keeping Assist-Roadedge)

The RKA-ROADEDGE (Lane Keeping Assist-Roadedge) is a driving assistance system that helps the driver's vehicle maintain a Road-edge through the steering wheel (EPS) control if the front camera module (FCM) recognizes the left and right roads in front and the driver's vehicle departs the Road-edge without using a turn signal in that direction.

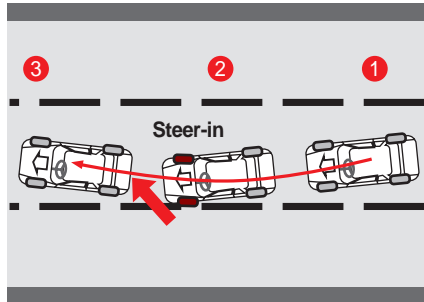

- 1 Road-edge departure detected with no turn signal operated
- 2 EPS steering control
- 3 Vehicle enters middle of driving road

Warning

- RKA-ROADEDGE is an assist system to precisely control the steering wheel so that the driver's vehicle does not leave the Road-edge, regardless of the driver's intention.

Activation / Deactivation

To activate ELK : Turn the ignition switch on.

To deactivate ELK : Please untick "ELK" in the User Settings on the instrument cluster.

Operating conditions

The RKA-Roadedge system is activated when:

- Vehicle travels at a speed between 60 km/h and 175 km/h
- Front camera recognizes left/right Road-edge
- Driving on a straight road or gentle curve
- Turn signal is not activated

Warning

- Do not release your hands from the steering wheel while driving.
- The driver is responsible for safe driving of the vehicle by maneuvering the steering wheel.
- The RKA-Roadedge does not always control the steering wheel automatically.

Warning

- The RKA-Roadedge may be deactivated, not work at all, or activated when it is not desired depending on the road conditions and surrounding environment.
- Never drive the vehicle in a dangerous or reckless manner to test the RKA-Roadedge.
- When replacing the steering wheel system-relevant parts, have the system checked and serviced at a KG Mobility Dealer or KG Mobility Authorized Service Center.

! Caution

- Do not attach sticker, accessory, tinting films on the detection area of the FCM. This can cause malfunctions and abnormal operation of the related systems.
- The RKA-Roadedge recognizes the Road-edge by using the images from the cameras. Keep in mind that the RKA-Roadedge may be deactivated or activated when it is not desired if the Road-edge are not recognized successfully.

! Caution

- Do not remove any part of the RKA-Roadedge or apply impact on it.
- Do not put any object with reflective surface (white paper, mirror, etc.) on the instrument panel. Reflected lights can cause system malfunction.
- Please note that when driving at high speed, the steering assist force of the RKA-Roadedge may be reduced, which can cause the vehicle to leave the Road-edge.

Does not work when:

- The driver activates the turn signal lamps or hazard warning lamp.
- The vehicle keeps being driven too close to any side of the lane after changing the lane.
- The driver changes the lane with abrupt steering wheel operation. (temporarily system inactivated)
- ESP system is activated.
- The vehicle is cornering at high speed.
- Vehicle speed is below 55 km/h or above 180 km/h
- The driver changes the lane abruptly.
- The lane is too narrow or too wide to recognize it.
- The vehicle is driven around a curve with too small radius.
- The vehicle is driven on steep hills.
- The vehicle decelerates abruptly.
- The windshield tinting film covers the detection range of the front camera module (FCM).

! Warning

- Activate the turn signal lamps before trying to make a lane-change.

! Caution

- Do not apply tinting film on the FCM detection area. This may cause the related system to malfunction or not work.

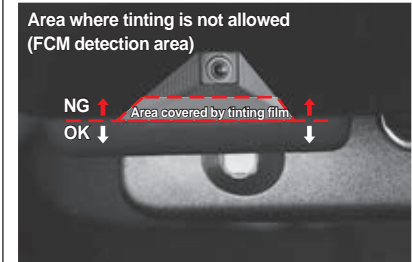

Driver Attention Required

The RKA-ROAEDGE may not work at all or be activated when it is not desired in the following conditions:

- The system cannot recognize the Road-edge markings because of rain, snow, dust, standing water or puddles, other obstruction on the road.
- The color of the Road-edge markings is not clearly distinct from the road color.
- The Road-edge markings are not clear.
- The Road-edge markings are covered in shadows of the median barriers, guardrails, noise barrier walls, roadside trees.
- There are environmental barriers, such as bollard.
- The Road-edge markings are suddenly discontinued at roundabouts and road intersections.
- The vehicle is passing through a certain section, such as highway interchange, where the number of lanes increases or decreases.
- The distance to the vehicle ahead is too short or a wheel of the vehicle ahead is touching the Road-edge marker.
- Poor visibility due to factors such as fog, heavy rain, heavy snow, etc.
- There is rapid change of illumination, for example at tunnel entry and exit points
- The headlamps are not turned on or the brightness of the lamps is too low when driving at night or through tunnels.
- The vehicle is driven on a steep hill or around sharp corners.
- The vehicle is driven under specific conditions which cause severe vibration.
- Objects with reflective surface (white paper, mirror, etc.) are on the dashboard.
- The windshield glass in front of the camera module is covered with ice, snow, slush, mud, dirt or debris.
- Fog or mist on the windshield.
- The temperature around the front view camera is too high because of the direct sunlight.
- The vehicle is moving towards a light source.
- The light from the sun, streetlamps, or headlamps of oncoming vehicles is reflected by the wet road surface.

TSR (Traffic signal recognition)*

It is the system which recognizes the speed limit of the traffic sign and other major signs.



Setting

Driver can set the function on the instrument cluster (Cluster Setting → Driving Assist) when the vehicle is switched on.

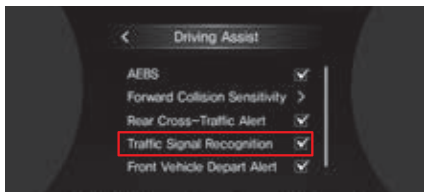

Notice

Recognizable Signs

- Vienna convention sign
- Standard traffic sign, Electronic sign, Prism sign



Caution

- TSR does not recognize all signs.
- It is possible that recognition is not available due to location, color or dents of sign.

FVSW (Front Vehicle Start Warning)*

It is a system that notifies the driver when the driver does not recognize that the ahead vehicle departed while the driver's vehicle is stationary, using the sensor (FCM) at front of the vehicle.

FVSW : Front Vehicle Start Warning

How To Set

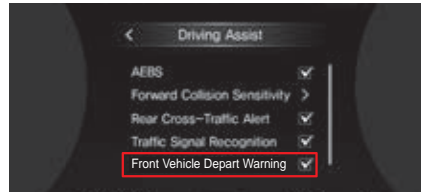

You can enable (check) or disable (uncheck) this feature under the instrument cluster main menu, "User Settings > Driving Assist > Front Vehicle Depart Warning" with the vehicle turned on.

Operation

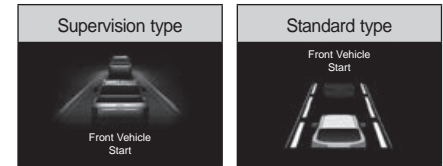

If the driver does not perform any operation (such as not starting the vehicle) about 1 second after the ahead vehicle departs, the message will be displayed on the LCD and alarm will sound.

Caution

- For safe driving, be sure to check the front and surrounding road conditions before starting the vehicle.

Parking assist system*

Front/rear obstacle detection system

The front/rear obstacle detection system is a parking assist system that detects an obstacle through the ultrasonic sensor installed on the bumper and informs the driver with a warning buzzer when the driver places the gear shift lever in the D (driving) or the R (reverse) position and drives the vehicle.

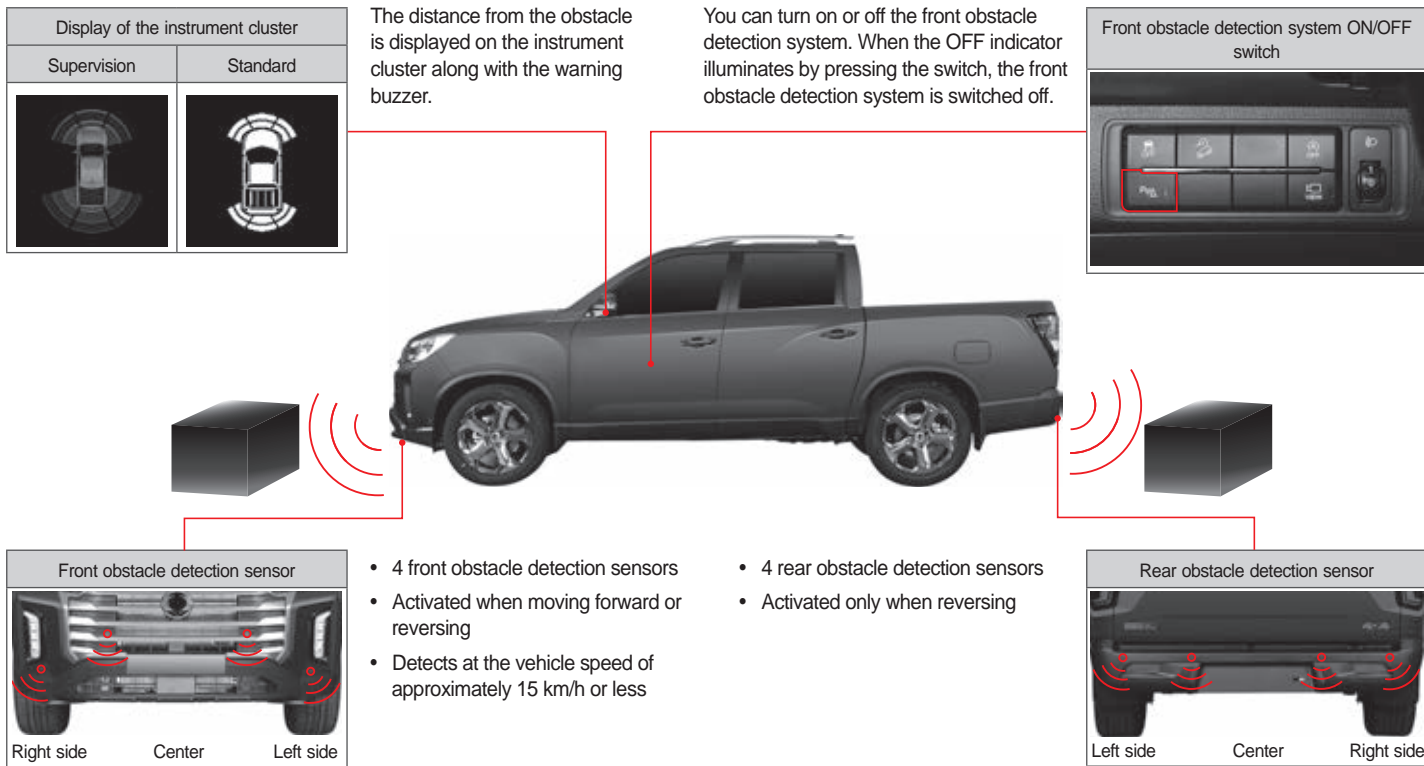

Activating the obstacle detection system

When an obstacle is detected through the front/rear obstacle detection sensor, the distance from the obstacle and the direction are displayed along with a warning buzzer according to the detected distance.

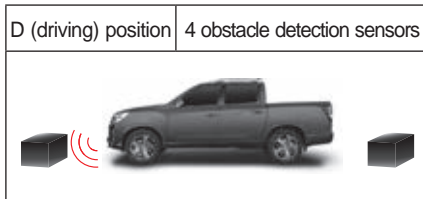

If the transmission selector lever is in the D (drive) position, the detection sensor operates when:

- Vehicle starts to move after initial start (at vehicle speed of 15 km/h or lower).
- Transmission selector lever is changed from R (reverse) position to D (drive) position (at vehicle speed of 15 km/h or lower).
- Front obstacle detection warning switch is turned on (at vehicle speed of 15 km/h or lower).

However, it will remain off after the vehicle speed exceeds 15 km/h.

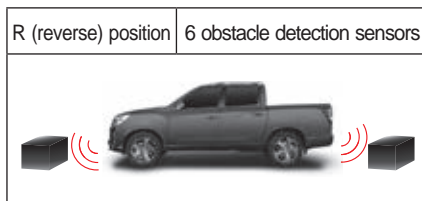

When the gear shift lever is placed in the R (reverse) position, 2 front obstacle detection sensors and 4 rear obstacle detection sensors are activated at the same time.

Notice
<ul style="list-style-type: none"> • The front obstacle detection sensor always works while reversing with the front obstacle detection alarm ON/OFF switch pressed (OFF indicator lit). • The front obstacle detection sensor always works at low speed. An alarm may sound intermittently in the event of rain and this is not a malfunction but normal operation.

Indication on the display of the instrument cluster

When an obstacle is detected, the relevant edge indicating the detection distance and direction blinks.

Standard type

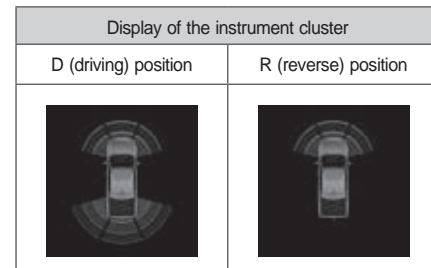



When no obstacle is detected



The range of front and rear sensors is displayed and blinks (no warning buzzer)

If an obstacle is detected from 40 cm at the front left side or the front right side



Line No. ① at the front left side is deleted and Line No. ② blinks (Warning buzzer sounds)

If an obstacle is detected from 80 cm at the rear left side, front side or right side



Line No. ③ at the rear right side is deleted and Line No. ④ blinks (Warning buzzer sounds)

Warning buzzer interval

The warning buzzer sounds as follows depending on the distance from the obstacle.

Front obstacle detection sensor (level 2 warning buzzer)

Warning buzzer interval	Distance from the obstacle	
	Center	Side
No warning buzzer	100 cm	60 cm
① 0.15 second	50 cm ~ 100 cm	40 cm ~ 60 cm
② Continuous	25 cm ~ 50 cm	25 cm ~ 40 cm

Rear obstacle detection sensor (Level 3 warning buzzer)

Warning buzzer interval	Distance from the obstacle	
	Center	Side
③ 0.3 second	80 cm ~ 120 cm	-
④ 0.15 second	50 cm ~ 80 cm	
⑤ Continuous	25 cm ~ 50 cm	

Sensor and relevant system malfunction

Standard type



Display of the instrument cluster

D (driving) position	R (reverse) position

When the obstacle detection sensor is abnormal, “?” is displayed for the relevant sensor. If this message is display on the display of the instrument cluster, have your vehicle checked and serviced at a nearby KG Mobility authorized service center.

! Caution

- If the distance between the sensor and the obstacle is 25 cm or less, the warning buzzer does not sound. However, if the obstacle is recognized clearly, the warning buzzer may sound.
- When the warning buzzer sounds, the distance from the obstacle may be different from the actual distance by approximately ± 10 cm.
- Do not rely too much on the parking assist system and reverse the vehicle while checking the rear side.
- If an abnormal warning buzzer whose duration is different from a warning buzzer that occurs due to the detection of an obstacle or a long warning buzzer for 3 seconds occur when the gear shift lever is placed in the R (reverse) position, the obstacle detection system or the detection sensor is abnormal. Have your vehicle checked.

If the system does not operate or malfunctions

If there is an object that cannot be detected by the sensor

- A thin object such as steel wire, rope or chain
- An object such as cotton, sponge, fiber or snow that absorbs sound waves
- An object that is located lower than the bumper (example : drainage or puddle)

The sensor cannot detect

- when the sensor is frozen (the normal function is restored after thawed.)
- When sensor is clogged by foreign materials such as snow, mud or water drops (the normal function is restored after removed)

When the sensor detection range becomes narrower

- The sensor is partially covered with snow or mud so that the signal detection area becomes narrower (the normal function is restored after removal)
- When the temperature near the sensor is extremely high or low

Cases that may cause malfunction although it is not a system failure

- Driving the vehicle on bumpy roads, gravel roads, hillside road, or grass
- When the height of the bumper is lowered due to heavy load
- When other ultrasound waves are received (metallic sound, air brake sound of a large vehicle, etc)
- When a high-power radio set is used
- When there is a heavy rain
- When an accessory is attached to or near the area where the sensor is installed

When towing a trailer

- The sensor may detect the trailer, sounding the warning buzzer continuously.

Cautions regarding the front/rear obstacle detection system



Caution

- When parking or reversing the vehicle, check if there is any person, animal or especially a child around. If you cannot check it properly, be sure to get out of the vehicle and check.
- The parking assist system is only a system for the user's convenience and this system does not guarantee safety. The driver should pay attention to all possible conditions.
- When you strongly press or apply an impact to the sensor part on the bumper or strong water pressure is applied during car wash, the sensor may be damaged.
- When the system is normal and the gear shift lever is placed in the R (reverse) position with the START/STOP switch in the ON status, a beep sounds once briefly.
- If an abnormal warning buzzer whose duration is different from a warning buzzer that occurs due to the detection of an obstacle or a long warning buzzer for 3 seconds occur when the gear shift lever is placed in the R (reverse) position, the obstacle detection system or the detection sensor is abnormal. Have your vehicle checked.

- In the parking space shown in the figure below, the upper portion of the vehicle may collide before the detection sensor at the bottom operates. Park the vehicle while checking through the outside rearview mirror or turning your head directly.



Rear camera system

The rear camera system is an auxiliary safety system that allows the driver to view the situation behind the vehicle through the rear camera using the monitor when the gear shift lever is placed in the R (reverse) position.

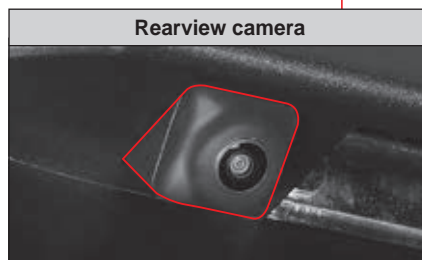
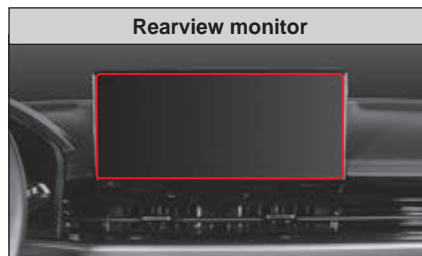
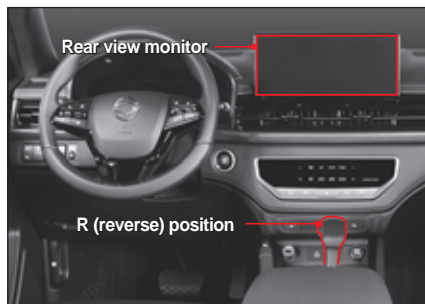

Caution

- The rear camera uses a wide-angle lens to secure a wide view, so the actual distance is different from what you see through the monitor. Be sure to check the rear, left and right view directly.
- The screen shown on the monitor is a part of, not the whole background view of the vehicle.
- Clean the rear camera lens frequently using a camera lens cleaner to prevent it from being contaminated.

Around View Monitoring (AVM) system

The AVM system is a parking assist system that helps the driver to park the vehicle safely by allowing the driver to view the outside situation in the vehicle through the monitor.

The driver can see the information received from 4 cameras installed on the exterior of the vehicle through the monitor. The driver can activate 3D view and check the outside of the vehicle in the desired direction if necessary.

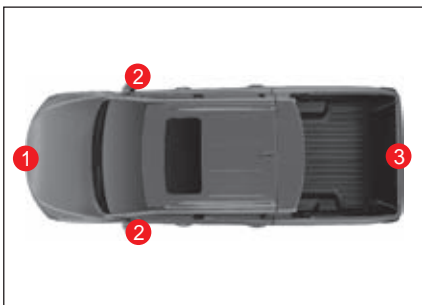

- ① Front camera
- ② Left/right camera
- ③ Rear camera

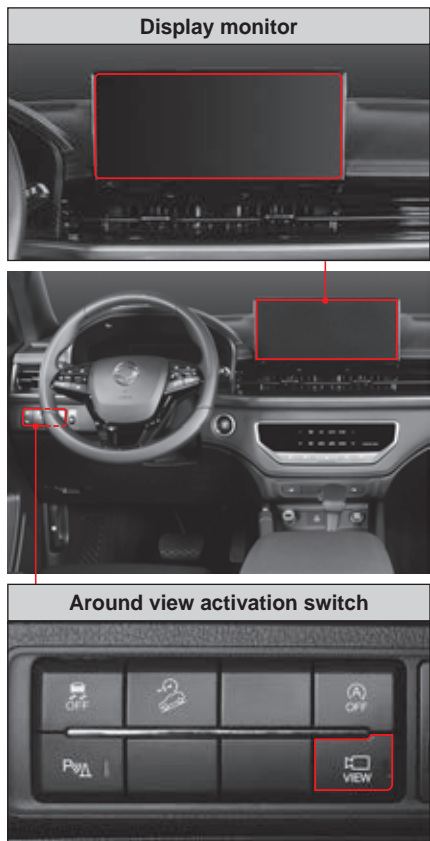

! Caution

- The AVM system combines 4 camera images and displays the combined image on the monitor. Therefore, the actual position of the vehicle and parking guide line are different from those shown in the screen. When parking the vehicle, be sure to check the rear, left and right view directly for safety.
- Since the AVM camera uses a wide-angle lens for securing wide view, the actual distance may be different from what you see through the monitor. Be sure to check the rear, left and right view directly for safety.
- If the surface of the camera lens is contaminated by foreign materials, a system error may occur due to performance degradation. Always keep the lens clean.

Activation conditions

When the following condition is met, the AVM system is activated.

- When the START/STOP switch is in the ON status or the engine is running
- When the vehicle speed is less than 20 km/h
- When the around view operation switch is turned on with the gear shift lever in P (parking), R (reverse), N (neutral) or D (driving) position

Notice

- If the gear shift lever is placed in the R (reverse) position, the AVR system is activated regardless of the switch ON/OFF status.
- If the gear shift lever is in the P (parking) position, the AVM system is activated, but the previous view is displayed on the monitor.
- When you drive the vehicle at a speed of approximately 20km/h or more with the front AVM activated, the AVM is deactivated. Even if the vehicle speed decreases to approximately 20km/h or less in this status, the AVM system remains deactivated.

AVM settings

To move to the AVM settings screen, press the  (Settings) button.

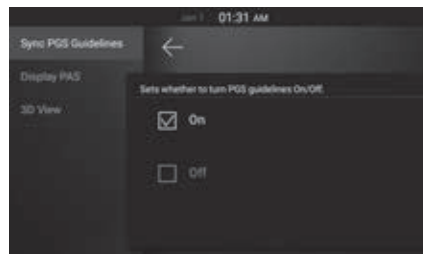

- **PGS guidelines linkage:** Sets the PGS guidelines linkage function ON/OFF.
- **PAS proximity warning display:** Sets PAS proximity warning display ON/OFF.
- **3D View:** When the 3D View is set, the screen is displayed in 3D mode.

Front AVM operation

When you press the  (camera) button with the gear shift lever placed in the N (neutral) or D (driving) position after starting the engine, the front AVM system is activated.

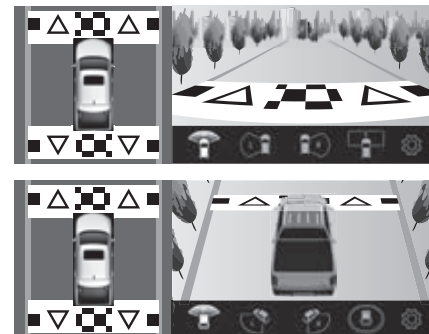

- **PAS information display:** The front and rear object detection result is displayed.
- **Front camera screen:** The front view from the camera is displayed.
- **Left camera screen:** The left view from the camera is displayed.

- Right camera screen: The right view from the camera is displayed.
- Whole front/3D screen:
 - In 2D mode, the whole front view is displayed.
 - In 3D mode, the whole 3D view is displayed.
-  (Settings): Moves to the settings screen of the AVM system.

Rear AVM operation

When you place the gear shift lever in the R (reverse) position after starting the engine, the rear AVM system is activated.

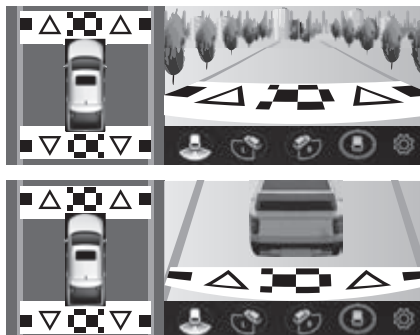

- PAS information display: The rear object detection result is displayed.
- Rear camera screen: The rear view from the camera is displayed.

- Left camera screen: The left view from the camera is displayed.
- Right camera screen: The right view from the camera is displayed.
- Whole rear/3D screen:
 - In 2D mode, the rear view is displayed.
 - In 3D mode, the view changes to the 3D view.
-  (Settings): Moves to the settings screen of the AVM system.

5. Emergency Measures in the Event of Emergency

You can check useful information and emergency measures for various emergency situations you can face while driving.

Information regarding the warning triangle and OVM tools, the correct procedure in case of a dead battery, engine overheating, flat tire, and towing a vehicle is provided. An explanation is also provided for how to respond to a fire, heavy snow, vehicle trouble, and an accident safely.

Warning triangle and OVM (Owner Vehicle Maintenance) tools

Warning triangle*

A warning triangle is a stop sign that should be placed in the rear side of the vehicle in order to prevent any secondary accidents in the event of emergency such as car trouble or the occurrence of an accident.

Carrying and placement of a warning triangle is mandatory by the Road Traffic Act. A fine is imposed if you violate it.

Storage place of the warning triangle



The warning triangle is stored at the bottom of the luggage board.



Caution

- The KS standard automotive warning triangle (sign of broken down vehicle) should be stored in the vehicle according to the Road Traffic Act. Failure to do so is subject to a fine.
- While paying particular attention to surrounding traffic conditions, place the warning triangle in a position where its reflecting plate can be clearly visible to vehicles approaching from the rear.
- Place a road flare in addition to the warning triangle at night.
- If your vehicle becomes operational again or the problem is fixed, move the vehicle promptly while paying particular attention to the traffic conditions.

OVM tools

The OVM tools are apparatuses or tools stored in the vehicle in preparation for a failure or an emergency situation that can occur while driving the vehicle.



- 1 Jack
- 2 Compressor
- 3 Sealant
- 4 Jack connection
- 5 Tow eye
- 6 Screwdriver (+ and -)
- 7 Spanner
- 8 OVM tool roll
- 9 Wheel nut wrench

- Spare tire*: 1, 4, 5, 6, 7, 8, 9
- Service kit: 2, 3, 5, 6, 7, 8

※ CE, UKCA certified parts: Compressor (2),
Jack (1)

(1) CE

- Representative: KG Mobility European Parts Center B.V.
- Address: IABC 5253&5254, 4814RD Breda, The Netherlands

(2) UKCA

- Importer: KG Mobility UK Ltd
- Address: G Offices, Parsonage Road, Stratton St. Margaret, Swindon, Wiltshire SN3 4RN

Location where the OVM tools are stored



Take out and use the OVM tools any time when necessary.

When the engine cannot be started due to depletion of the battery

If the engine cannot be started due to depletion of the battery, you can start the engine by connecting a battery of the same standard and capacity from another vehicle or an auxiliary battery to your battery using the jump cable.

Starting the engine using the jump cable

Move another vehicle that has the same 12 V power or an auxiliary battery closely to the depleted battery that can be reached by the jump cable and start the engine according to the following order.

- 1 Switch off all electrical accessories of the depleted vehicle.
- 2 Place the gear shift lever of the depleted vehicle in the P (parking) position and apply the parking brake.
- 3 Connect the jump cable in the following order.
 - + terminal (1) of the depleted battery
 - + terminal (2) of the battery in another vehicle or an auxiliary battery that provides power supply
 - - terminal (3) of the battery in another vehicle or an auxiliary battery that provides power supply
 - Vehicle body of the depleted vehicle (4) (a location far from the battery)

- 4 If the battery of another vehicle is used, start the engine of the relevant vehicle and idle the engine for several minutes.
- 5 Start the engine of the depleted vehicle.

- 6 When the engine is started, separate the jump cable in the following order.
 - Jump cable connected to the minus (-) terminal
 - Jump cable connected to the positive (+) terminal

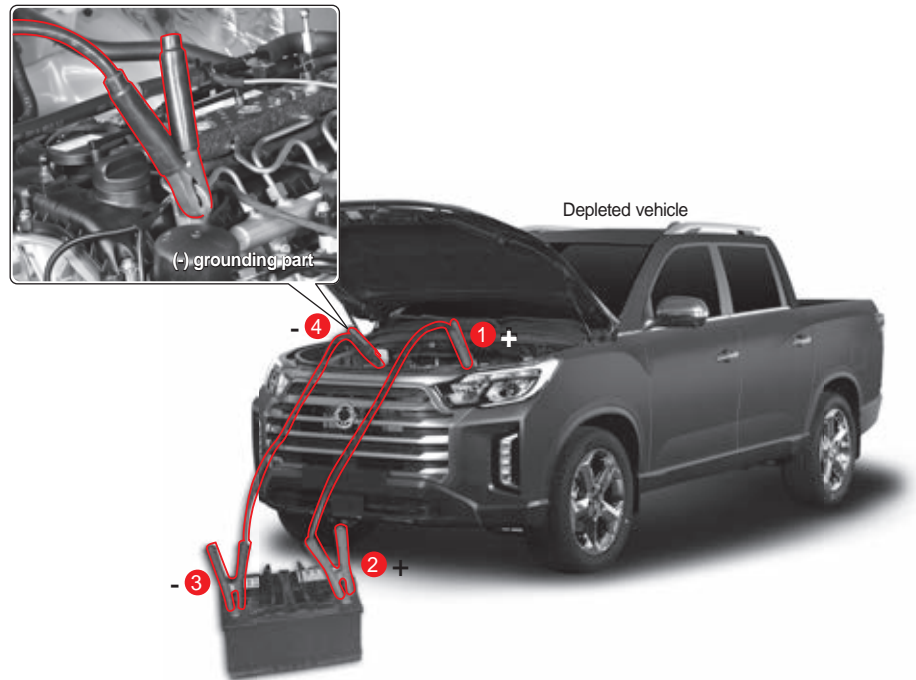



Warning

- Follow the procedure to start the engine using the jump cable explained in this owner's manual. Failure to do so may cause an injury or damage the vehicle due to a battery explosion.
- If the battery is frozen, do not attempt to start the engine using the jump cable. Doing so may lead the battery to burst or explode, causing serious injury.
- Be sure to wear insulated gloves for starting the engine using the jump cable to prevent an electric shock.
- Make sure that two vehicles do not come into contact with each other. Failure to do so may result in ground connection status, causing an electric shock and a vehicle failure.
- Be sure to use the jump cable of the specified standard and a battery of the same standard and capacity. Failure to do so may cause a spark when the jump cables are connected and gas generated from the battery may explode.
- When using the battery of another vehicle, connect the jump cable with the engine of the other vehicle turned off for safety.
- When connecting the jump cables, make sure that the positive (+) and negative (-) cables do not come into contact with each other. Otherwise, an electric spark may occur, resulting in the explosion of the battery.

- Do not connect the jump cable to the negative (-) terminal of the depleted battery directly. Otherwise, an electric spark may occur, resulting in the explosion of the battery. Be sure to connect the jump cable to the vehicle body of the depleted vehicle.
- Make sure that the jump cables are securely fixed to each terminal. Failure to do so may cause disconnection due to an instantaneous vibration when the engine is started. If the jump cable is separated and comes into contact with the vehicle body, an electric shock may be applied to the vehicle, damaging electric and electronic components.
- The battery fluid is very acidic, so if it comes into contact with your eyes or on your skin, take off the clothes that are stained with the battery fluid immediately, rinse the contacted area with clean water continuously and contact your doctor. While being transported to a hospital, gently wipe the contacted area with a water-wet soft cloth or sponge continuously.



Caution

- Make sure when starting the engine that the jump cable is not wound around the fan in the engine room.
- After starting the engine using the jump cable, do not turn off the engine for a certain period of time to allow the depleted battery to be recharged. Otherwise, you may not be able to start the engine again according to the charging status of the battery.
- If the cause of the depleted battery is not clear, have your vehicle checked at a KG Mobility authorized service center.

When the engine is overheated or other problems have occurred

When the engine is overheated so that the warning light turns on



When the engine is overheated, various symptoms appear such as the warning light turns on and steam comes out from the engine.

In such case, park your vehicle at a safe place immediately and take the necessary action.



Symptoms that appear when the engine is overheated

- The engine overheat warning lamp blinks and the warning buzzer sounds.
- The coolant temperature gauge indicates the H part.
- Steam comes out from the engine.
- A decrease in the engine output

Emergency measures when the engine is overheated

Place the warning triangle at the rear side of the vehicle, evacuate all occupants to a safe place, check for safety again if necessary and take emergency measures according to the following procedure.

- 1 Place the gear shift lever in the P (parking) position and apply the parking brake.
- 2 Turn off the heater and the air conditioner.
- 3 Open the engine hood so that the engine room can be well ventilated.

At this time, if steam comes out of the engine, turn off the engine immediately.

If steam does not come out, idle the engine continuously with the engine hood opened.

If the coolant temperature gauge does not go down while the engine is idling, turn off the engine and let it cool down properly.

- 4 Check the coolant level on the coolant reservoir.

If the coolant level is low, add coolant and check if a leak occurs from the connecting part of each hose and the radiator.

Cover the reservoir cap with a cloth, turn it a little bit to release steam pressure, remove the cap and add the coolant. Close the reservoir cap after adding the coolant.

If the engine is overheated when the coolant level is normal, have the cooling systems (including the electric fan) and belts checked and serviced at a KG Mobility authorized service center.



Warning

- **Caution should be taken that hot steam or coolant may come out when you open the engine hood.**
- **Be careful not to allow your clothes or hands to come into contact with the driving parts (belts, etc.) of the engine when you open the engine hood while the engine is running.**
- **Do not open the coolant reservoir cap rapidly when the engine is hot. Hot steam or water may come out, causing a burn. Be sure to open the coolant reservoir cap slowly after the engine is turned off and the engine has been cooled down properly.**



Caution

- If the engine is overheated with insufficient coolant, turn off the engine immediately, cool down the engine and add coolant.
- Do not add cold coolant suddenly when the engine is overheated. Doing so may damage the engine or the radiator.
- Only use the KG Mobility genuine coolant that meets the standard.
- If the engine is overheated continuously after taking the emergency measures, have your vehicle checked and serviced at a KG Mobility authorized service center.

Accident or fire



If your vehicle catches on fire, don't panic. Evacuate any occupants and use the extinguisher.

Accident

Turn on the emergency hazard warning switch. If possible, move your vehicle to a safe place to avoid any secondary accidents. If anyone is injured, call an ambulance and contact the nearest police station.

Fire

Stop immediately in a safe place. Turn off the engine. Use fire extinguishers to put out the fire. If it is impossible to extinguish the fire, contact the nearest fire or police station.



Warning

- In an accident, fuel can be released from the vehicle. Therefore, stop the engine and avoid any sparks or flames.
- If you have even a minor burn, see your doctor.

When the engine check indicator turns on

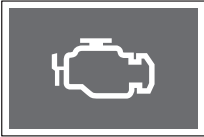

The engine check indicator turns on when various sensors (including automatic transmission) and equipment related to the engine control are abnormal.

If the engine check indicator turns on while driving, have your vehicle checked and serviced at a KG Mobility authorized service center.

☞ Refer to "Emission reduction device" (p.6-62)



Caution

- If the engine check indicator turns on, the driving power of the engine may decrease or the engine may stall.

When the water separator warning light turns on (diesel-powered vehicle)

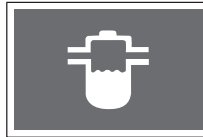

If water in the fuel filter exceeds a prescribed level, the water separator warning light turns on and the driving force of the engine decreases in addition to the warning buzzer.

At this time, water should be removed from the fuel filter immediately.

Have your vehicle checked and serviced at a nearby KG Mobility authorized service center.



Caution

- Driving the vehicle continuously with the water separator warning light turned on may damage the vehicle fuel system and the engine significantly.
- If low quality fuel that contains a large amount of water is used, water may be accumulated faster in the fuel filter, turning on the water separator warning light. Never use low quality fuel.

When a tire is flat



If a tire becomes flat while driving, do not panic and take action according to the following order.

- 1 Turn on the hazard warning lamp indicator.
- 2 Stop the vehicle at a safe place.
For such purpose, hold the steering wheel firmly, take your foot off the accelerator pedal, decelerate the vehicle slowly and depress the brake pedal slightly to stop the vehicle safely.
- 3 Place the gear shift lever in the P (parking) position and apply the parking brake.
- 4 Place a chock in front of and at the back of the tires located in the diagonal direction of the flat tire.

- 5 Be sure to place the warning triangle on a road or an expressway where other vehicles are driving.

The position that is easily identified by a driver in an approaching vehicle while maintaining a safe distance (100 m during daytime, 200 m in the rear during night time) is an appropriate place to place the warning triangle.

- 6 If there are other occupants besides the driver, evacuate such occupants to a safe place.
- 7 Judge if the flat tire can be repaired using the service kit for tire repair (stored in the storage box of the luggage compartment) and take the necessary action accordingly.

Warning

- If a tire becomes flat while driving, do not steer the vehicle or depress the brake suddenly. Doing so may cause the vehicle to lose its stability, leading to an accident.
- Do not drive the vehicle for even a short distance with a flat tire. Doing so may damage the wheels and disable normal driving, leading to a dangerous situation.
- Turn on the hazard warning lamp indicator, move the vehicle to the shoulder of the road or a safe location and place the warning triangle in a place easily identified by a driver in an approaching vehicle.
- If possible, park the vehicle on a flat, solid, and non-slippery road surface and repair the tire with no occupants in the vehicle.

Notice

- If you are not good at repairing a flat tire, request a KG Mobility authorized service center or your auto insurance company for help.

Repairing a flat tire/inflating a tire using the service kit for tire repair

Components of the service kit for tire repair (Type A)

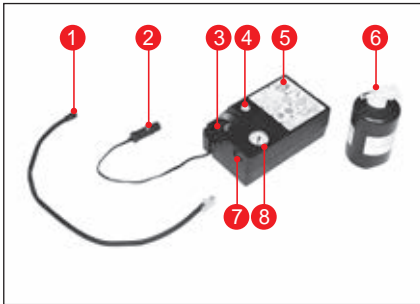

- 1 Air hose
- 2 Power cable
- 3 Sealant installation part
- 4 Air release switch
- 5 Compressor
- 6 Sealant
- 7 Power switch
- 8 Pressure gauge

Storage location of the service kit



You can access the service kit from the floor rear box by reclining the rear seat back.

Confirming whether it is possible to repair the flat tire with the service kit or not

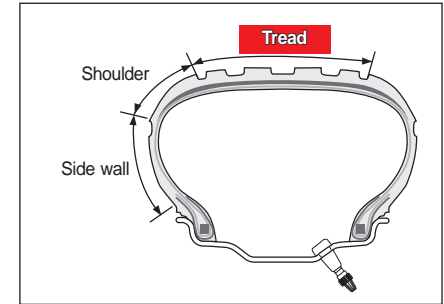

When a tire is flat, check the position of the hole first and use the service kit after judging whether it can be repaired using the service kit or not.

- If the size of the hole on the tread of the tire is less than 6 mm, it can be repaired using the service kit.

Warning

- Do not repair the tire using the service kit if the tire shoulder or the side wall is torn or there is a sign of cracks or damage. In such case, have the tire checked and serviced at a KG Mobility authorized service center or contact your car insurance company.

Operating principle of the service kit

When the vehicle is driven after the sealant is injected using the compressor, the sealant is spread on the inner surface of the tire, filling up the hole and enabling temporary driving.

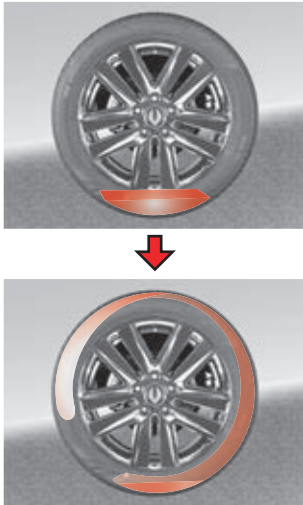

Repairing a flat tire

When a tire is flat, it can be repaired in the following method using the service kit.

- 1 Take the service kit out of the floor rear box (OVM tool box and service kit storage box).



- 2 Detach the speed limit sticker from the bottom surface of the sealant container and attach it to the steering wheel.



Caution

- The speed limit sticker alerts the driver that the tire has been repaired using the service kit and the speed should be limited. Do not drive the vehicle at a speed faster than 80 km/h at any time.

- 3 Connect the air hose (1) of the service kit to the connecting part of the sealant container (2).

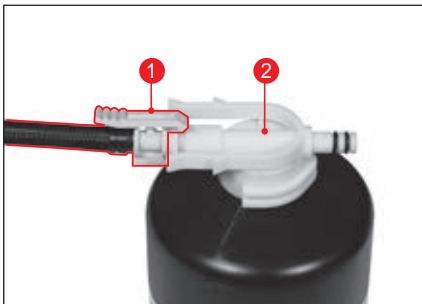

⚠ Caution

- Check the expiration date of the sealant. The expiration date is marked on top of the sealant. Replace expired sealant with a new one since the sealing performance of the expired sealant may be degraded.
- Be sure to read the cautions on the container before using the sealant.

Notice

- Before using the sealant, shake the container well to mix the contents.

- 4 Fix the sealant container onto the compressor body completely.

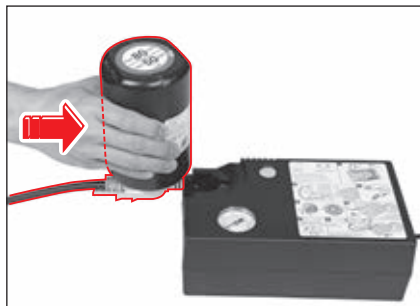

- 5 Remove the air valve cap of the flat tire.
6 Connect the air hose of the sealant container to the air valve on the flat tire firmly.



⚠ Caution

- The power switch of the service kit should be in the OFF position.

- 7 Insert the power cable of the service kit into the USB charging port on the front side of the central console.



Warning

- Do not connect the power cable of the service kit (12V/20A, 240W) to the power socket (12V/10A, 120W) of the vehicle. Doing so may overload the electric system of the power socket, causing a fire or damaging the electric accessories.

- 8 Start the engine.

Warning

- Be sure to repair a tire in a well-ventilated area. Failure to do so may lead to suffocation due to exhaust gas after starting the engine.

- 9 Press the power switch of the service kit to activate the compressor.



Caution

- Do not operate the compressor for more than 10 minutes. Doing so may overheat the compressor, leading to a malfunction.

- 10 Wait until the pressure reaches the prescribed pressure (34psi, 2.3bar) while checking the pressure gauge of the service kit.

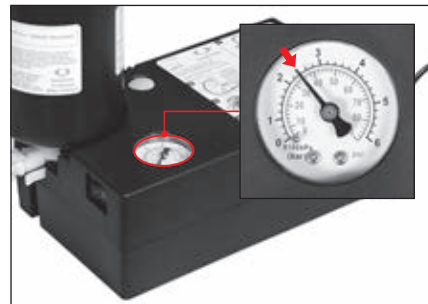

If the tire is overinflated, press the air pressure release button to adjust the tire pressure.



- 11 When the prescribed pressure is reached, turn off the service kit.



Caution

- If the tire pressure does not go above 26psi after operating the compressor for more than 10 minutes, the tire cannot be repaired using the service kit. Request an emergency rescue service or vehicle towing.

- 12 Disconnect the air hose from the tire.
- 13 Install the air valve cap on the tire.
- 14 Turn off the engine.
- 15 Remove the sealant container and the air hose from the service kit and place the service kit back to its original position (storage box at the rear left side of the luggage compartment).
- 16 Drive the vehicle immediately for approximately 10 km to allow the sealant to be spread on the inner surface of the tire evenly.
- 17 Stop the vehicle at a safe place and measure the tire pressure with the service kit.



Warning

- Use the service kit only when a small hole (approximately 6 mm or less) has occurred on the tread of the tire.
- Do not use the service kit if the tire shoulder or side wall is torn or the hole is too large. In such case, have your vehicle towed or serviced at a KG Mobility authorized service center.
- When a tire repaired using the service kit is fixed, drive the vehicle at a speed less than 80 km/h.
- The service kit should be used only for temporary repair. The maximum distance that can be traveled with a tire repaired by injecting sealant is approximately 200 km.
- If a vibration occurs or the steering is unstable and a noise occurs while driving, stop driving the vehicle immediately. In such case, have your vehicle serviced at a KG Mobility authorized service center.



Caution

- Remove the sealant container carefully to prevent the sealant from coming into contact with your skin. If sealant comes into contact with your skin, wash it with soapy water.
- The sealant container cannot be used after it is used once. Just in case, purchase and replace with new sealant.
- Do not discard the used sealant container anywhere. Return it to a KG Mobility authorized service center.
- Do not use an unauthorized sealant which is not KG Mobility genuine sealant. Doing so may damage the sensor of the TPMS.
- Replace the tire repaired using the sealant with a new one at a KG Mobility authorized service center as soon as possible and have the TPMS checked for abnormality.
☞ Refer to "Tire pressure monitoring system (TPMS)*" (p.2-26)

Checking the tire pressure after repairing a flat tire

The pressure of the tire repaired using the service kit should be checked as follows after driving for approximately 10 km.

- 1 Take out the service kit from the storage box at the rear left side of the luggage compartment.
- 2 Take out the air hose from the service kit.
- 3 Remove the air valve cap of the tire.
- 4 Connect the air hose of the service kit to the air valve on the tire firmly.
- 5 Check the tire pressure from the pressure gauge of the service kit.

If the tire pressure is higher or lower than the prescribed pressure (34psi, 2.3bar), adjust it to the prescribed pressure using the air valve of the tire.



Warning

- If the tire pressure is not maintained at the prescribed pressure (34psi, 2.3bar), stop driving the vehicle immediately and request a KG Mobility authorized service for help.

Inflating a tire

When the tire pressure is insufficient, you can inflate the tire to the prescribed pressure with the following method using the service kit.

- 1 Take out the service kit from the storage box at the rear left side of the luggage compartment.
- 2 Take out the air hose and the power cable from the service kit.



- 3 Connect the air hose to the compressor in the service kit.

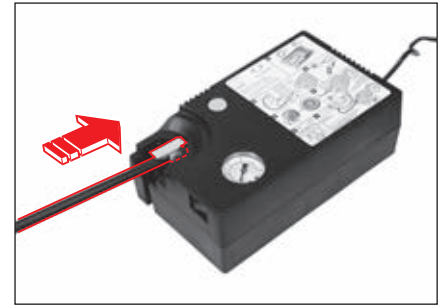

4 Remove the air valve cap of the tire you wish to inflate.

5 Connect the air hose of the service kit to the air valve on the tire firmly.



⚠ Caution

- The power switch of the service kit should be in the OFF position.

6 Insert the power cable of the service kit into the USB charging port on the front side of the central console.



⚠ Warning

- Do not connect the power cable of the service kit (12V/20A, 240W) to the power socket (12V/10A, 120W) of the vehicle. Doing so may overload the electric system of the power socket, causing a fire or damaging the electric accessories.

7 Start the engine.

⚠ Warning

- Be sure to repair a tire in a well-ventilated area. Failure to do so may lead to suffocation due to exhaust gas after starting the engine.

8 Press the power switch (1) of the service kit to activate the compressor.

9 Wait until the pressure reaches the prescribed pressure (34psi, 2.3bar) while checking the pressure gauge (2) of the service kit.

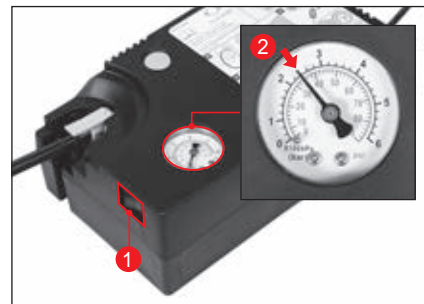

If the tire is overinflated, press the air pressure release button to adjust the tire pressure.



- 10 When the prescribed pressure is reached, press the power switch (1) of the service kit to turn it off.

Caution

- Do not operate the compressor for more than 10 minutes. Doing so may overheat the compressor, leading to a malfunction.

- 11 Turn off the engine.
- 12 Disconnect the air hose from the tire.
- 13 Install the air valve cap on the tire.
- 14 Place the service kit back to its original position (storage box at the rear left side of the luggage compartment).

Components of the service kit for tire repair (Type B)

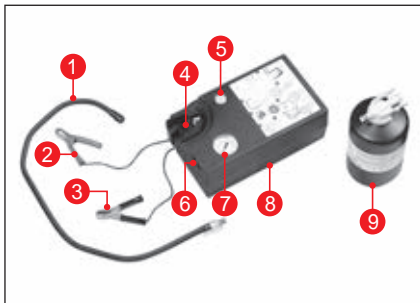

- 1 Air hose
- 2 Positive (+) cable
- 3 Negative (-) cable
- 4 Sealant installation part
- 5 Air release switch
- 6 Compressor
- 7 Sealant
- 8 Power switch
- 9 Pressure gauge

Repairing a flat tire

When a tire is flat, it can be repaired in the following method using the service kit.

- 1 Take out the service kit from the storage box at the rear left side of the luggage compartment.



- 2 Detach the speed limit sticker from the bottom surface of the sealant container and attach it to the steering wheel.



⚠ Caution

- The speed limit sticker alerts the driver that the tire has been repaired using the service kit and the speed should be limited. Do not drive the vehicle at a speed faster than 80 km/h at any time.

- 3 Connect the air hose (1) of the service kit to the connecting part of the sealant container (2).

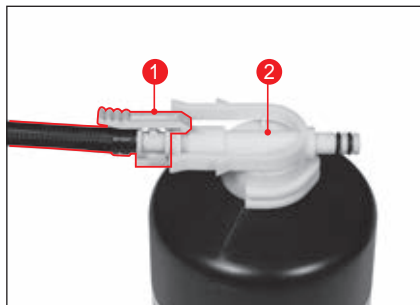

⚠ Caution

- Check the expiration date of the sealant. The expiration date is marked on top of the sealant. Replace expired sealant with a new one since the sealing performance of the expired sealant may be degraded.
- Be sure to read the cautions on the container before using the sealant.

Notice

- Before using the sealant, shake the container well to mix the contents.

- 4 Fix the sealant container onto the compressor body completely.

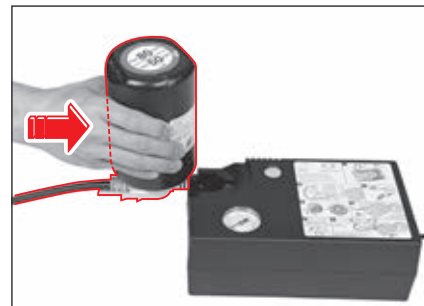

- 5 Remove the air valve cap of the flat tire.
- 6 Connect the air hose of the sealant container to the air valve on the flat tire firmly.



! Caution

- The power switch of the service kit should be in the OFF position.

- 7 Connect the + (red) (1) cable of the service kit to the vehicle battery and then connect the - (black) (2) cable.

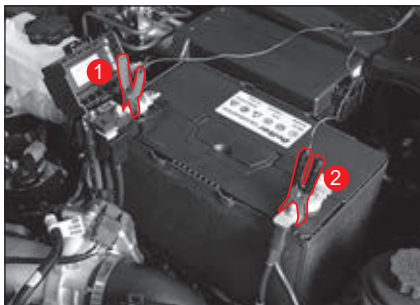

! Warning

- Use caution when connecting the cables. Sparks may occur.

! Caution

- Connecting the positive (+) and negative (-) terminals of the battery in reverse may result in damage to the battery and the tire service kit. Be sure to connect the cables in the correct order.
- Be sure to start with removing the negative (-) terminal (black cable) when disconnecting the cables.

- 8 Start the engine.

! Warning

- Be sure to repair a tire in a well-ventilated area. Failure to do so may lead to suffocation due to exhaust gas after starting the engine.

- 9 Press the power switch of the service kit to activate the compressor.



! Caution

- Do not operate the compressor for more than 10 minutes. Doing so may overheat the compressor, leading to a malfunction.

- 10 Wait until the pressure reaches the prescribed pressure (34psi, 2.3bar) while checking the pressure gauge of the service kit.

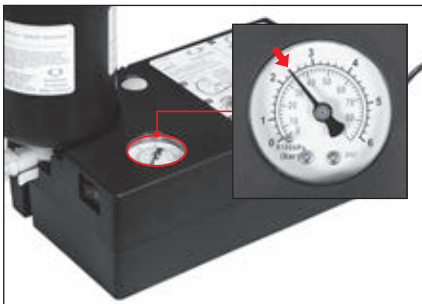

Warning

- If the specified tire pressure is not reached within 8 minutes (however, current tire pressure has reached at least 26 psi), re-inflate the tire as described below:
 1. Stop using the service kit and remove the sealant from the compressor.
 2. Place the service kit back in place (bottom of the luggage compartment board).
 3. Drive the vehicle at low speed for about 10 m so that the sealant is applied on the inner surface of the tire evenly.
 4. Fit the air injection hose at the compressor to the flat tire.
 5. Connect the power cable at the bottom of the compressor to the vehicle battery.
 6. Start the engine to operate the compressor.
 7. Operate the compressor until the tire pressure reaches to the specified value (34 psi, 2.3 bar).

If the tire is overinflated, press the air pressure release button to adjust the tire pressure.



- 11 When the prescribed pressure is reached, turn off the service kit.

Caution

- If the tire pressure does not go above 26psi after operating the compressor for more than 10 minutes, the tire cannot be repaired using the service kit. Request an emergency rescue service or vehicle towing.

- 12 Disconnect the air hose from the tire.
- 13 Install the air valve cap on the tire.
- 14 Turn off the engine.
- 15 Remove the sealant container and the air hose from the service kit and place the service kit back to its original position (storage box at the rear left side of the luggage compartment).

16 Drive the vehicle immediately for approximately 10 km to allow the sealant to be spread on the inner surface of the tire evenly.

17 Stop the vehicle at a safe place and measure the tire pressure with the service kit.



Warning

- Use the service kit only when a small hole (approximately 6 mm or less) has occurred on the tread of the tire.
- Do not use the service kit if the tire shoulder or side wall is torn or the hole is too large. In such case, have your vehicle towed or serviced at a KG Mobility authorized service center.
- When a tire repaired using the service kit is fixed, drive the vehicle at a speed less than 80 km/h.
- The service kit should be used only for temporary repair. The maximum distance that can be traveled with a tire repaired by injecting sealant is approximately 200 km.
- If a vibration occurs or the steering is unstable and a noise occurs while driving, stop driving the vehicle immediately. In such case, have your vehicle serviced at a KG Mobility authorized service center.



Caution

- Remove the sealant container carefully to prevent the sealant from coming into contact with your skin. If sealant comes into contact with your skin, wash it with soapy water.
- The sealant container cannot be used after it is used once. Just in case, purchase and replace with new sealant.
- Do not discard the used sealant container anywhere. Return it to a KG Mobility authorized service center.
- Do not use an unauthorized sealant which is not KG Mobility genuine sealant. Doing so may damage the sensor of the TPMS.
- Replace the tire repaired using the sealant with a new one at a KG Mobility authorized service center as soon as possible and have the TPMS checked for abnormality.
☞ Refer to “Tire pressure monitoring system (TPMS)” (p.2-26)

Checking the tire pressure after repairing a flat tire

The pressure of the tire repaired using the service kit should be checked as follows after driving for approximately 10 km.

- 1 Take out the service kit from the storage box at the rear left side of the luggage compartment.
- 2 Take out the air hose from the service kit.
- 3 Remove the air valve cap of the tire.
- 4 Connect the air hose of the service kit to the air valve on the tire firmly.
- 5 Check the tire pressure from the pressure gauge of the service kit.

If the tire pressure is higher or lower than the prescribed pressure (34psi, 2.3bar), adjust it to the prescribed pressure using the air valve of the tire.



Warning

- If the tire pressure is not maintained at the prescribed pressure (34psi, 2.3bar), stop driving the vehicle immediately and request a KG Mobility authorized service for help.

Inflating a tire

When the tire pressure is insufficient, you can inflate the tire to the prescribed pressure with the following method using the service kit.

- 1 Take out the service kit from the storage box at the rear left side of the luggage compartment.
- 2 Take out the air hose and (+) red / (-) black cables from the bottom of the service kit box.

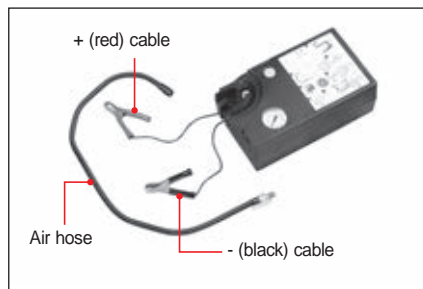

- 3 Connect the air hose to the compressor in the service kit.

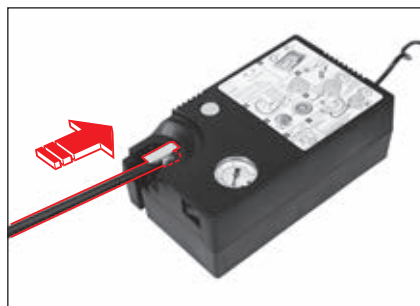

- 4 Remove the air valve cap of the tire you wish to inflate.
- 5 Connect the air hose of the service kit to the air valve on the tire firmly.



Caution

- The power switch of the service kit should be in the OFF position.

- 6 Connect the + (red) **(1)** cable of the service kit to the vehicle battery and then connect the - (black) **(2)** cable.

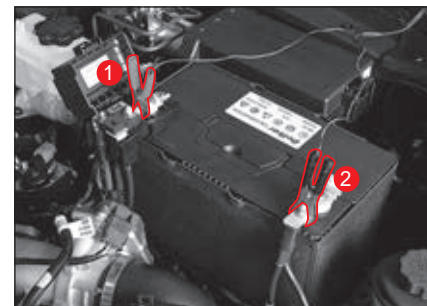

Warning

- Use caution when connecting the cables. Sparks may occur.

Caution

- Connecting the positive (+) and negative (-) terminals of the battery in reverse may result in damage to the battery and the tire service kit. Be sure to connect the cables in the correct order.
- Be sure to start with removing the negative (-) terminal (black cable) when disconnecting the cables.

7 Start the engine.

Warning

- Be sure to repair a tire in a well-ventilated area. Failure to do so may lead to suffocation due to exhaust gas after starting the engine.

8 Press the power switch (1) of the service kit to activate the compressor.

9 Wait until the pressure reaches the prescribed pressure (34psi, 2.3bar) while checking the pressure gauge (2) of the service kit.

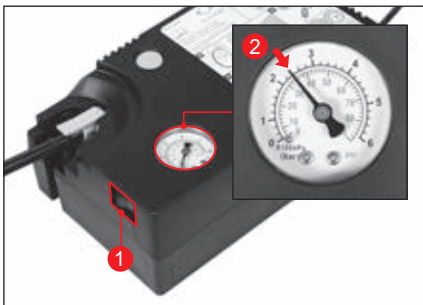

If the tire is overinflated, press the air pressure release button to adjust the tire pressure.



10 When the prescribed pressure is reached, press the power switch (1) of the service kit to turn it off.

Caution

- Do not operate the compressor for more than 10 minutes. Doing so may overheat the compressor, leading to a malfunction.

11 Turn off the engine.

12 Disconnect the air hose from the tire.

13 Install the air valve cap on the tire.

14 Place the service kit back to its original position (storage box at the rear left side of the luggage compartment).

Removing the spare tire



1 Insert the connection rod in the hole located in the upper center of the bumper after opening the tailgate, and then connect the wheel nut wrench to it.

2 Turn the wheel nut wrench counter-clockwise to lower the spare tire.

3 When the spare tire is on the ground, remove the tire by prying off the lift plate.

Caution

- When reinstalling the spare tire to the carrier, be sure to securely lock it to the carrier holder.
- While your vehicle is being raised up with the jack, avoid any impact on your vehicle. Otherwise, you may get injured.

Warning

- The emergency spare tire is only for emergency situations. Never use it for normal driving. After installing the spare tire on a wheel, take your vehicle to a KG Mobility authorized service center or a tire-specialized shop to replace it with a new regular tire.

Changing a spare tire



- 1 Chock the front and rear of the wheel diagonally opposite to the wheel being changed.

Warning

- The parking brake should always be applied when replacing the flat tire.

- 2 Loosen the wheel nuts two or three turns by turning them counterclockwise with the wheel nut wrench.

Caution

- When reinstalling the wheel cap, be sure to completely fit it into its location.

Warning

- Do not remove the nuts yet from the wheel. If they are removed, the wheel could slip off from the vehicle. Then, the body of the vehicle will fall down on you and you may get seriously injured.
- Loosen the wheel nuts two or three turns.
- The parking brake should always be applied when replacing the flat tire.
- Chock the front and rear of the wheel opposite to the wheel being changed.

When replacing a front tire

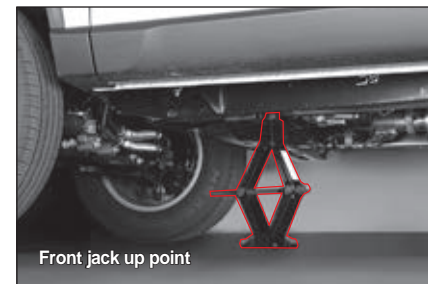

- 3 Place the jack directly under the jack-up points so that the top of the jack contacts the vehicle at the jack-up point.

Warning

- The jack should be used on level firm ground wherever possible.
- It is recommended that the wheels of the vehicle be chocked, and that no person should remain in a vehicle that is being jacked.
- No person should place any portion of their body under a vehicle that is supported by a jack.
- Jack working load limit 1,300 kg.

When replacing a rear tire

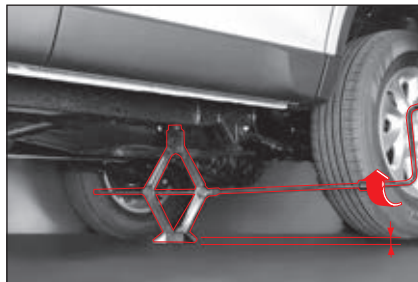
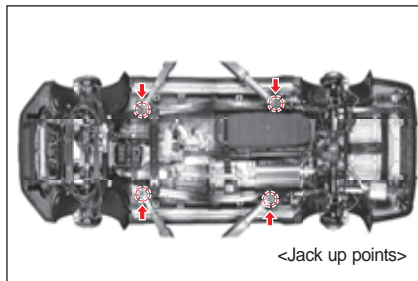
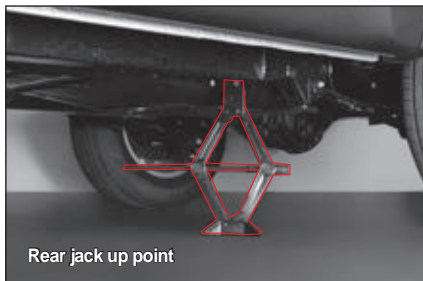

- 4 Combine the jack, jack extension and the wheel nut wrench as shown in the figure. Raise up the vehicle by rotating the combined wrench clockwise until the tire is off from the ground about 3 cm.

- 5 Remove the wheel nuts by hands while the vehicle is stationary. Remove all of the wheel nuts.

Warning

- Do not attempt to raise the vehicle until the jack is in the proper position, and secure both to the vehicle and the ground. It may cause a personal injury or vehicle damage.

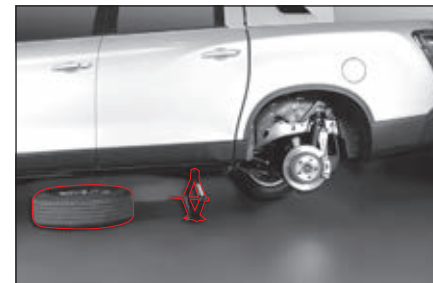

- 6 Take the wheel off and place the wheel under the vehicle body. This helps to minimize any danger if the jack slip off position.

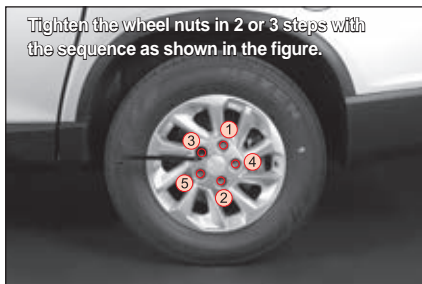

Tighten the wheel nuts in 2 or 3 steps with the sequence as shown in the figure.

7 Then mount the spare tire and temporarily tighten the wheel nuts until the spare tire wheel is no longer loose.

Warning

- By tightening up the spare tire until it is not loose any more, you can avoid any tilting of the tire on the wheel hub when the tire touches the ground.

8 Lower the vehicle by rotating the combined wrench counter-clockwise until the tire touches the ground. Remove the jack.

Warning

- While the jack is supporting your vehicle, do not use too much force to tighten the nuts. Otherwise, the vehicle may slip off and you may get injured.

9 Tighten the wheel nuts in 2 or 3 steps with the sequence as shown in the figure.

10 When done with mounting the spare tire, place the flat tire in the luggage room. Store the jack and other emergency tools in their storages.

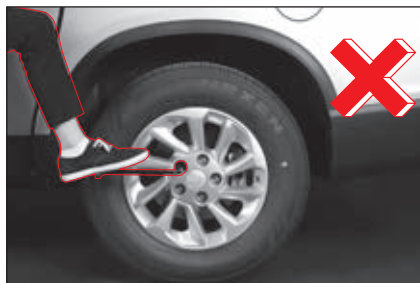

If over tightened, the wheel nuts could be damaged. Do not overtighten the wheel nuts by pressing the wheel nut wrench by foot or using an assist pipe.

Caution

- After changing the tire and driving the vehicle about 1000 km, retighten the wheel nuts.
- Wheel nut tightening torque: 120 ~ 140 Nm

Warning

- With the emergency spare tire, do not drive any faster than 60 km/h.
- The temporary spare tire is only for emergency situations. Never use it for normal driving. After installing the spare tire on a wheel, take your vehicle to a KG Mobility authorized service center or a tire-specialized shop to replace it with a new regular tire.
- Improperly tightened wheel nuts can cause the wheel to become loose and even come off or any malfunctioning in the steering and braking system.
- This could lead to an accident. Be sure to tighten the wheel nuts as specified. If the wheel comes off due to a loose wheel nut, you may have a fatal accident.
- Using different tires could cause you to lose control while driving. Be sure to use the same size and type tires from the same manufacturer on all wheels.

Cautions when changing the tire

Caution

- ▶ **Before changing the tire**
 - Turn on hazard flashers and move off the road to a safe place away from traffic. Park on a firm and level ground.
 - Set up the jack at the specified position. Never get under the vehicle while it is supported by the jack. While the vehicle is on the jack, never start or run the engine or push the vehicle.
 - Have all passengers get out of the vehicle and stay in a place away from traffic.
- ▶ **During changing the tire**
 - Do not completely tighten the wheel nuts at a time. Tighten the wheel nuts in the diagonal sequence in 2 or 3 steps.
 - Never apply oil or grease to either wheel studs or nuts as it will cause them to overtighten.

▶ **After changing the tire**

- Check, repair, and retighten the replaced tire at the nearest KG Mobility Authorized Service Center or a qualified tire shop after an emergency change.
- Securely fix the tire in its carrier. Check to see if the spare tire is securely locked into the carrier without any looseness. Otherwise, it may make some abnormal noises or fall out from the carrier on the road while the vehicle is moving. This may cause an accident or hit a pedestrian.
- If this happens, the fallen tire can be a great danger to other vehicles or people. Check the tightness of the wheel nuts and tire pressure before driving.
- The spare tire is designed as an emergency spare only. Do not exceed 60 km/h speed when the spare tire is installed on the vehicle.

Caution

- Repair or change the flat tire. Stow the emergency tire in its location properly.
- Make sure to check the tightness and inflation pressure of tires before driving.
- In the vehicle equipped with TPMS, the TPMS warning lamp comes on and TPMS does not work when installing the emergency tire.

Warning

- Make sure that tighten the wheel nuts again after driving of about 1,000 km when the tires have been replaced.
- Drive the vehicle at the speed of 60km/h or less (maximum speed 80 km; maximum distance 200 km) when the vehicle is driven with the spare tire.
- Drive the vehicle in 2H mode when the spare tire is fitted. When driving in 4H mode, it will damage the drive system.
- Be sure to use the same size and type tires of the same manufacturer on all wheels so that the vehicle characteristics can be maintained safely.

When you need to have your vehicle towed

Towing a disabled vehicle

- Flat towing

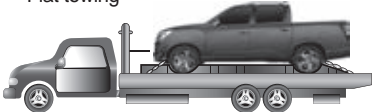

- Towing with front wheels on ground



Dolly

- Towing with rear wheels on ground



Dolly

Towing with tow truck

The best towing method is to lift the entire vehicle onto the flatbed so that all wheels are off the ground. If it is impossible, put the front or rear wheels on the jig and tow the vehicle using a dolly, with other wheels off the ground.

For 4WD vehicle

Your vehicle must be towed with a wheel lift and dollies or flatbed equipment with all the wheels off the ground.



Warning

- The 4WD system equipped vehicle should never be towed with the wheels on the ground. This can cause serious damage to the transmission or the 4WD system.
- If your vehicle should be towed due to wheel slips in mud or sand, you can use the towing hooks in your vehicle. However, if the load to hooks is too heavy, the towing hook, rope or chain could be broken, resulting in serious personal injury and vehicle damage.
- To prevent damage to your vehicle, proper lifting and towing procedures are necessary. When you need a towing service, contact KG Mobility Dealer or KG Mobility Authorized Service Center.

For 2WD vehicles

It is not allowed to use a tow truck or keep the rear wheels from moving with the parking brake released for towing, as shown in the following figure.

Do not tow the vehicle with the rear wheels on the ground.



Caution



- Do not tow with the sling-type equipment or the bumper and lower parts can be damaged.
- If the vehicle is towed with the driving wheels on the ground, the transmission may be damaged.
- Be careful not to damage the bumper and lower parts during towing.

When a tow truck is unavailable (in case of emergency)

If your vehicle needs to be towed when a tow truck is unavailable, you can have your vehicle towed by installing the towing hook to a towing vehicle and the vehicle to be towed and connecting the two vehicles with the towing rope (sold separately).

Installing the towing hook

- 1 Take out the towing hooks from the OVM tools stored in the storage box at the rear left side of the luggage compartment.
- 2 Press the bottom side (1) of the hole cover located in the front bumper of the vehicle to be towed and the rear bumper of the towing vehicle each to remove the cover.
- 3 Insert the towing hook into each hole and fasten it firmly.

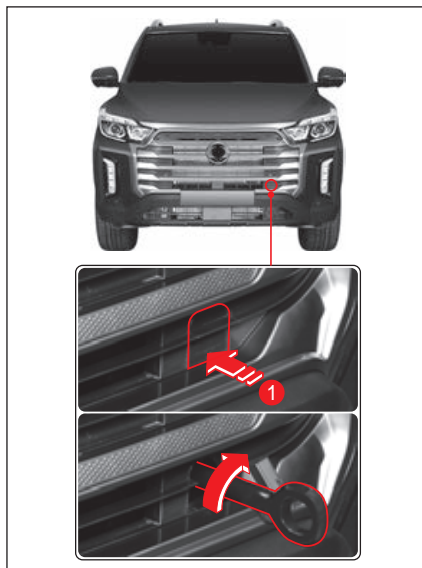

Using a towing rope

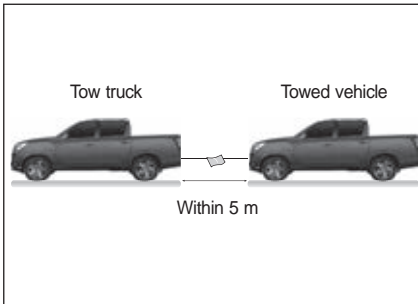

- 1 Connect the towing rope to the towing hook of the towing vehicle and the vehicle to be towed securely.
- 2 Tie a white cloth in the middle of the rope so that the towing rope is clearly visible.
- 3 Release the parking brake of the vehicle to be towed and place the gear shift lever in the N (neutral) position.
- 4 If the engine of the vehicle to be towed is turned off, place the START/STOP switch in the ON position.
- 5 Turn on the hazard warning lamp of both the towing vehicle and the vehicle to be towed.

- 6 Start the engine of the towing vehicle and tow the vehicle to be towed.

At this time, the length of the towing rope should be less than 5 m and the total length of the towing vehicle and the vehicle to be towed should not exceed 25 m.

Tow the vehicle at a speed of 5 km/h or less.



Warning

- Use the towing hook only for towing a vehicle for a short distance temporarily or in an emergency situation. Avoid using it for towing all the time.
- If you want to tow the vehicle using the towing hook, make sure that the force is applied in the front, rear and horizontal direction. Do not drive off suddenly or recklessly since it can apply excessive load to the towing hook. Doing so may damage the towing rope or chain, leading to vehicle damage or a serious injury.



Caution

- Avoid impractical towing and towing a vehicle which is heavier than the towing vehicle.
- If there are many steep downhill or slopes in the towing path, do not attempt to tow the vehicle using the towing hook.
- The brake performance is significantly lowered while the engine is not running. Therefore, depress the brake pedal stronger than usual when towing the vehicle using the towing hook.
- Tow the vehicle while operating the turn signal and the hazard warning lamp along with the towing vehicle's signals.

Trailer towing

Your vehicle is designed primarily as a passenger vehicle therefore handling, braking, durability and economy will be affected by towing a trailer.

Your safety and satisfaction depend upon proper use of correct equipment. Also, you should avoid overloading and other abusive use.

The maximum loaded trailer weight you can pull with your vehicle depends on your intended use and what special equipment has been installed on it. Before attempting any towing, ensure that the correct equipment is fitted to your vehicle.

Your KG Mobility Dealer will help supply and install towing equipment to suit your requirement.

Trailer loading

To load your trailer properly, you must know how to measure gross trailer weight and trailer ball weight. Gross trailer weight is the weight of the trailer plus all cargo in it.

You can measure gross trailer weight by putting the fully loaded trailer on a vehicle scale.

Trailer ball weight is the downward force exerted on the hitch by the trailer coupler at its normal towing height. This weight can be measured using a bathroom scale.

The weight of your loaded trailer (gross trailer weight) should never exceed the specified values.

The permissible trailer loads are valid for several gradients from 6.8% to 12.6% according to engine power applied.

When the trailer has been coupled, the permissible rear axle load for the fully loaded towing vehicle (including occupants) must not be exceeded.

Maximum Load Limits

MUSSO

unit: kg, []: 2WD

Engine	Type	Maximum Trailer	Trailer coupling weight		
			Maximum permissible static vertical load on the coupling device	Maximum trailer hitch	
EU/GENERAL (EU6b, EU6d)	D22DTR	with brake	M/T 2,800 [2,800]	112 [112]	25
			A/T 3,000 [2,800]	120 [112]	
	without brake	M/T 750 [750]	30 [30]		
		A/T			
GENERAL (EU4)	D22DTR	with brake	2,300 [2,300]	92 [92]	25
		without brake	750 [750]	30 [30]	
	G20DTR	with brake	M/T 2,300 [2,300]	92 [92]	25
			A/T		
	without brake	M/T 750 [750]	30 [30]		
		A/T			

MUSSO GRAND (5-Link)

unit: kg, []: 2WD

Engine		Type		Maximum Trailer	Trailer coupling weight	
					Maximum permissible static vertical load on the coupling device	Maximum trailer hitch
EU/ GEN- ERAL (EU6b, EU6d)	D22DTR	with brake	M/T	2,600 [2,600]	104 [104]	25
			A/T	3,000 [2,600]	120 [104]	
		without brake	M/T	750 [750]	30 [30]	
			A/T			

MUSSO GRAND (Leaf)

unit: kg, []: 2WD

Engine		Type		Maximum Trailer	Trailer coupling weight	
					Maximum permissible static vertical load on the coupling device	Maximum trailer hitch
EU/GEN- ERAL (EU6b, EU6d)	D22DTR	with brake	M/T	2,600 [2,600]	104 [104]	25
			A/T	3,000 [3,000]	120 [120]	
		without brake	M/T	750 [750]	30 [30]	
			A/T			
GEN- ERAL (EU4)	D22DTR	with brake	2,300 [2,300]	92 [92]	25	
		without brake	750 [750]	30 [30]		
	G20DTR	with brake	2,000 [2,000]	80 [80]	25	
		without brake	750 [750]	30 [30]		

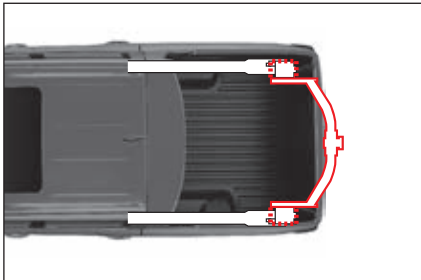
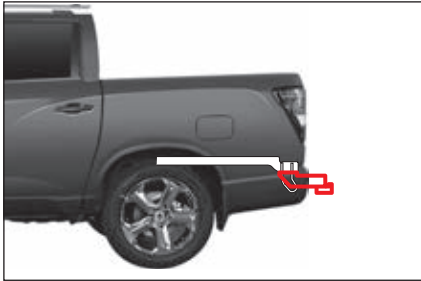

If you want to pull a trailer

Important points:

- You have to consider a sway control. You can check the sway control to hitch dealer.
- If the total driving distance of your new vehicle is under 800 km (500 miles), do not tow a trailer. For the first 800 km (500 miles) that you tow a trailer, do not drive over 80 km/h (50 mph) and do not start off your vehicle at full throttle. Otherwise, your engine and other parts could be damaged due to heavier loads.
- Always drive your vehicle at a moderate speed (less than 80 km/h).
- You have to consider the weight of trailer.
- The permissible trailer ball weight varies according to the cargo weight on the deck.
- It has to be limited to the number of passengers by 5 people including a driver.

Weight of trailer

To keep the vehicle and trailer safely, you must consider many factors except the maximum load limit.

The vehicle and trailer's safety depends on how you use your trailer. Vehicle speed, altitude, load, outside temperature and frequency of using trailer are all very important. Any special equipment on your vehicle also affects on your vehicle.

Weight of trailer tongue

The tongue load of a trailer is also considered very carefully because it affects the gross vehicle weight (GVW) of your vehicle. This weight includes the curb weight of vehicle, any luggage in trailer, and the passengers in vehicle. In addition to that, you must add the trailer tongue load to the GVW because your vehicle will carry all the weight.

The trailer tongue should weigh a maximum of 4% of total loaded trailer weight. To check the weights are proper, you must weigh the trailer and the tongue separately after loading. If the weights are not proper, unload some items from the trailer.

Caution

- **Never load a trailer with more weight in the rear side than in the front side. (Recommendation - Front: approx. 60%, Rear: approx. 40%)**
- **Never exceed the maximum load limits of trailer or trailer towing equipment. Improper loading may result in damage to your vehicle. It may occur the personal injury. Before driving, check the weight and loading at a commercial scale or highway patrol office equipped with scales.**
- **An improperly loaded trailer may cause the loss of vehicle control.**

Trailer brakes

If the trailer brakes are used, you should follow all instructions provided by the manufacturer. Never modify the brake system of your vehicle.

Trailer lights

Make sure your trailer is equipped with lights which meet country and local requirements.

Always check for the proper operation of all trailer lights before you start to tow.

Tires

When towing trailers, be sure your tires are properly inflated to the inflation pressure.

Safety chains

Always attach safety chains between your vehicle and the trailer. Cross the safety chains under the tongue of the trailer so that the tongue will not drop to the road if it becomes separated from the hitch. Follow the manufacturer's recommendation for attaching safety chains. Always leave just enough slack to permit full turning. Never allow safety chains to drag on the road.

Brake fluid

Change the brake fluid every 15,000 km (9,000 miles) under the following conditions.

- Towing a trailer frequently.
- Driving in hilly or mountainous terrain.

Automatic transmission fluid

More frequent maintenance is required if your vehicle tows trailer frequently.

Towing tips

When towing a trailer, your vehicle will handle differently compared with normal driving condition.

- For safety, observe the following precautions:
- Practice turning, stopping, and reversing before you begin towing in traffic.
Do not tow in traffic until you are confident that you can handle the vehicle and trailer safely.
- Before driving, make sure that the lighting system of the trailer works properly.
- Do not drive faster than 80 km/h.
- Make sure that you have enough room when cornering and avoid sudden maneuvers.
- Avoid abrupt starts, acceleration or stops.
- Avoid sharp turns or lane changes.
- Always have someone guide you when reversing.

- Allow adequate stopping distance.
Stopping distance is increased when you tow a trailer.
- Avoid holding the brake pedal down too long or too frequently, which will cause the brakes to overheat and result in reduced brake efficiency.
- Always block the wheels on both vehicle and trailer when parking. Apply the parking brake firmly.
- Parking on a steep slope is not recommended. You really should not park your vehicle, with a trailer attached, on a hill.
If something goes wrong, such as the trailer/ caravan hitch becoming disengaged, people can be injured and both the vehicle and trailer can be damaged.
- If someone removing the blocks stands directly behind the trailer, he could be injured. If your brakes or the hitch slipped, the trailer could roll backward. Make sure anyone removing blocks from your wheels stands to one side.
- Take note of trailer manufacturer's instructions.

Driving on hill

Reduce speed and shift to a lower gear before you start down a long or steep downgrade. If you don't shift down, you might have to use your brakes so much that they would get hot and no longer work well.

On a long uphill grade, shift down and reduce your speed to a level which minimizes the possibility of engine and transmission overheating.

Notice

- **When towing a trailer on steep hill (over 12%), pay particular attention to the engine coolant temperature gauge to ensure the engine does not overheat. If the gauge reaches to the “H” mark, stop your vehicle at a safe place and allow the engine to idle until it cools down. When the engine has cooled sufficiently, you may proceed.**
- **To avoid the engine and transmission overheating, you must check the driving speed depending on trailer weight and uphill grade.**

Parking on hills

You really should not park your vehicle, with a trailer attached, on a hill. If something goes wrong, your rig could start to move. People can be injured, and both your vehicle and the trailer can be damaged.

But if you ever have to park your rig on a hill, here's how to do it:

- 1 Apply your regular brakes, but don't shift into PARK (P) for automatic transmission yet, or into a gear for a manual transmission.
- 2 Have someone place chocks under the trailer wheels.
- 3 When the wheel chocks are in place release the regular brakes until the chocks absorb the load.
- 4 Reapply the regular brakes. Then apply your parking brake, and then shift to PARK (P) for automatic transmission, or First or Reverse gear for a manual transmission.
- 5 Release the regular brakes.

When you are ready to leave after parking on a hill

- 1 Apply your regular brakes and hold the pedal down while you:
 - Start your engine
 - Shift into a gear and
 - Release the parking brake.
- 2 Let up on the brake pedal.
- 3 Drive slowly until the trailer is clear of the chocks.
- 4 Stop and have someone pick up and store the chocks.

Maintenance when towing trailer

Your vehicle will need service more often when you're towing a trailer. See the maintenance Schedule for more on this. Things that are especially important in trailer operation are engine oil, brake pads & discs, automatic transmission fluid. Each of these is covered in this manual and the index will help you find them quickly. If you want to tow a trailer, it's a good idea to review these sections before you start your trip.

Check periodically to see that all hitch nuts and bolts are tight.

When the vehicle has stopped due to a failure

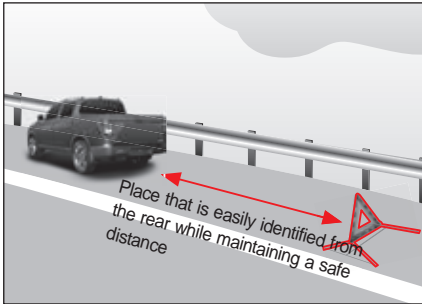

If the vehicle malfunctions and has stopped while driving, do not panic and take an action according to the following order.

- 1 Turn on the hazard warning lamp of the vehicle.
- 2 Move your vehicle to the right shoulder of the road or a safe location.
- 3 Place a warning triangle.
The position that is easily identified by a driver in an approaching vehicle while maintaining a safe distance (100 m during daytime, 200 m in the rear during night time) is an appropriate area to place the warning triangle.
Place a road flare additionally at night.
- 4 Evacuate all occupants to a safe place.
- 5 Request an emergency rescue service or vehicle towing.

In the event of an accident

If an accident has occurred while driving, do not panic and take an action according to the following order.

- 1 Turn on the hazard warning lamp of the vehicle.
- 2 Move your vehicle to the right shoulder of the road or a safe location.
- 3 Place a warning triangle.
The position that is easily identified by a driver in an approaching vehicle while maintaining a safe distance (100 m during daytime, 200 m in the rear during night time) is an appropriate area to place the warning triangle.
Place a road flare additionally at night.
- 4 Evacuate all occupants to a safe place.
- 5 If anyone is injured, give aid and call an ambulance.
- 6 Contact the nearest police station and when a police officer arrives, follow his/her instructions.
- 7 Even in case of a minor accident, be sure to visit a hospital and see the doctor.

Tips when an accident or a malfunction occurs on the expressway

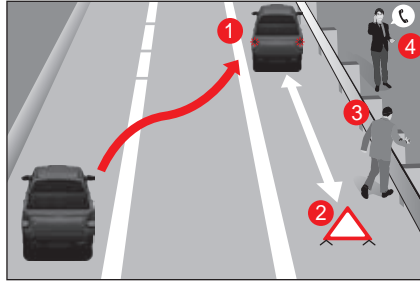

When you stop the vehicle on the expressway due to an accident or a malfunction, take an action according to the following order in order to prevent a secondary accident.

- 1 Turn on the hazard warning lamp promptly and move the vehicle to the shoulder of the road (1).
- 2 Place a warning triangle on the rear side of the vehicle (2). (Place a road flare additionally at night)
- 3 The driver and any occupants should be evacuated to a safe area such as behind the guardrail (3).
- 4 Call a police station (112), a fire station (119) or Korea Expressway Corporation (1588-2504) and ask for help (4).

In the event of a fire

When a fire has occurred in the vehicle, do not panic and take an action according to the following order.

- 1 Turn on the hazard warning lamp of the vehicle.
- 2 Stop the vehicle at a safe place immediately and stop the engine.
- 3 Extinguish the fire using an extinguisher.
- 4 If you cannot extinguish the fire, report it to a police station or a fire station.

At this time, do not approach the vehicle and maintain a safe distance with the vehicle.



Warning

- **When a vehicle accident occurs, the fuel may leak, causing a fire. Stop the engine immediately and keep any Inflammables away from the vehicle.**



Placing an extinguisher in the vehicle

Place an extinguisher in the vehicle since it is needed for early fire extinguishing when a fire occurs.

Purchase a fire extinguisher from your nearest fire fighting equipment store and keep it in your vehicle.

Notice

- **Refer to the label attached to the extinguisher for detailed information regarding tips to use and manage the extinguisher.**

How to use the extinguisher*

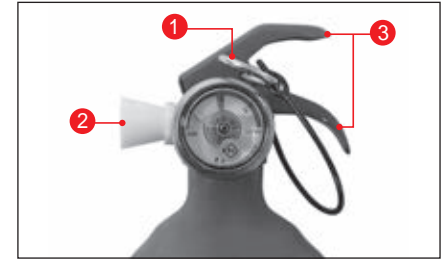

- 1 Remove the safety pin (1) from the extinguisher with the wind at your back.
- 2 Face the extinguisher nozzle (2) towards the place where the fire occurs.
- 3 Hold the handle (3) and spray to the place where the fire occurs, using a sweeping motion.

Checking and maintaining the extinguisher

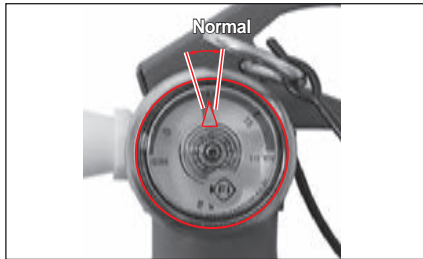

- Check at least once a month if the needle on the pressure gauge of the extinguisher is in the normal range.
If there is a pressure loss or other abnormalities, have the extinguisher serviced immediately.
- The lifetime of the extinguisher is approximately 5 years when it is maintained under normal conditions.
After 5 years have passed, it should be inspected and confirmed by a fire fighting equipment company every 2 years.
- After using the extinguisher, be sure to release the chemical (ABC powder) from the inside of the extinguisher completely and refill with an ABC powder fire extinguishing agent.
If it is left unattended for a long period of time, the contents may become hardened and it cannot be used. Shake the extinguisher periodically.

In the event of a heavy snow

When there is a heavy snow, do not panic and refer to the following tips for actions.

- Always listen to the radio and use the expressway information call number.
- Drive slowly on a curved road, an uphill road or a bridge.
- Avoid parking or leaving the vehicle on the shoulder of the road that cause inconvenience for snow removal operations.
- Be sure to leave your contact information when you leave the vehicle unavoidably.
- Drive slowly while securing a safe distance between vehicles.
- Avoid using the brake and stop the vehicle while reducing the vehicle speed using the engine brake.
- Remove snow near the vehicle frequently to prevent the exhaust pipe (muffler) from being blocked.

6. Periodic Checking and Maintenance

You can check the necessary periodic check and maintenance methods in detail for safe and pleasant vehicle driving.

Scheduled maintenance services (EU) - D22DTR

* Use only approved KG Mobility genuine parts.

Maintenance service and record retention are the owner's responsibility. You should retain evidence that proper maintenance has been performed on your vehicle in accordance with the scheduled maintenance service chart.

* EU Countries: Only countries that belong to EU. (It does not apply to all countries in EU.)

MAINTENANCE ITEM	MAINTENANCE INTERVAL	Kilometers (miles) or time in months, whichever comes first								
		x1000 km	20	40	60	80	100	120	140	160
		x1000 miles	12.5	25	37.5	50	62.5	75	87.5	100
		Months	12	24	36	48	60	72	84	96

ENGINE CONTROL SYSTEM

Drive belt	I	I	I	I	I	I	I	I	I
* Engine oil & filter ¹ (1)* (3)* (4)*	R	R	R	R	R	R	R	R	R
	Shorten the service interval under severe conditions								
Cooling system hose & connections	I	I	I	I	I	I	I	I	I
Engine coolant (3)* (4)*	Change every 200000 km or 5 years. And, inspect and replenish if necessary.								
* Fuel filter (1)*	I	R*	I	R*	I	R*	I	R*	I
	Draining water from fuel filter: whenever replacing the engine oil								
Fuel line & connections	I	I	I	I	I	I	I	I	I
Air cleaner (2)*	R	R	R	R	R	R	R	R	R
	Shorten the service interval under severe conditions								
Urea solution level	Regularly check / add (add immediately when low urea solution warning lamp comes on and warning message displayed)								
Urea line / connection oil leakage	I	I	I	I	I	I	I	I	I

Chart Symbols:

- I - Inspect these items and their related parts. If necessary, correct, clean, replenish, adjust or replace.
 - *1 Check the engine oil level and leak every 3000 km (2000 miles) or before starting a long trip.
- R - Replace or change.
 - (1)* If vehicle is operated under severe condition: Shorten the service interval.
 - Frequent stop-and-go traffic, extended idling, short driving distance below 6 km, driving distance below 16 km when the outside temperature remains below freezing

- Driving in a hilly or mountainous terrain, sandy, or dusty area
- High load driving such as trailer towing
- Taxi, patrol service or delivery service (extended idling and excessive driving with low speed)
- (2)* If vehicle is operated under severe condition, driving in dusty condition or sandy condition, pollutant area or off-road driving, frequently inspect the air cleaner, if necessary, change the air cleaner.
- (3)* More frequent maintenance is required if under dusty driving condition.
- (4)* Refer to "Recommended fluids, coolant and lubricants".

* Use only approved KG Mobility genuine parts.

* EU Countries: Only countries that belong to EU. (It does not apply to all countries in EU.)

MAINTENANCE ITEM	MAINTENANCE INTERVAL	Kilometers (miles) or time in months, whichever comes first								
		x1000 km	20	40	60	80	100	120	140	160
		x1000 miles	12.5	25	37.5	50	62.5	75	87.5	100
		Months	12	24	36	48	60	72	84	96

CHASSIS AND BODY

Exhaust pipes & mountings		I	I	I	I	I	I	I	I
Brake / Clutch fluid (3)*		Change every 2 years (inspect frequently)							
Parking brake / Brake pads (Front & Rear) (4)*		I	I	I	I	I	I	I	I
Brake line & connections (including booster) (4)*		I	I	I	I	I	I	I	I
Manual transmission oil (5)*				I			I		
Clutch & brake pedal free play		I	I	I	I	I	I	I	I
Transfer case fluid (3)*		I	I	R	I	I	R	I	I
		Frequent check of oil leak							
Axle oil	Front	I	R	I	R	I	R	I	R
	Rear	I	R	I	R	I	R	I	R
Automatic transmission fluid (6)*		Inspect and replenish every 3 years/60000 km After that inspect every 30000 km, if necessary replenish and replace. (Inspect and replace every 60000 km under severe condition)							
Check play/tightness for lower bolt/nut and ball joint grease leak on chassis and body (6)*		Check frequently and adjust or replace if necessary							

Chart Symbols:

I - Inspect these items and their related parts. If necessary, correct, clean, replenish, adjust or replace.

R - Replace or change.

(3)* Refer to "Recommended fluids and lubricants".

(4)* More frequent maintenance is required if the vehicle is operated under any of the following conditions:

- In heavy city traffic where the outside temperature regularly reaches 32°C (90°F) or higher, or
- In hilly or mountainous terrain, or
- When doing frequent trailer towing, or
- Uses such as found in taxi, police or delivery service.

(5)* Inspect and replenish every 60000 km (or 3 years)

Normal driving condition: Fill for Life

(Severe driving condition: Change every 120000 km)

(6)* If vehicle is operated under severe condition: Shorten the service interval.

- Towing a trailer or off-road driving (Inspect the leak of fluid at any time, occasionally)
- Taxi, patrol service or delivery service (extended idling and excessive driving with low speed)
- Frequent stop-and-go traffic, extended idling, short driving distance
- Driving in a hilly or mountainous terrain, sandy, or dusty area
- Driving frequently at high speed over 170 km/hour
- Driving frequently in area where heavy traffic under the ambient temperature above 32°C

* Use only approved KG Mobility genuine parts.

* EU Countries: Only countries that belong to EU. (It does not apply to all countries in EU.)

MAINTENANCE ITEM	MAINTENANCE INTERVAL	Kilometers (miles) or time in months, whichever comes first								
		x1000 km	20	40	60	80	100	120	140	160
		x1000 miles	12.5	25	37.5	50	62.5	75	87.5	100
		Months	12	24	36	48	60	72	84	96

CHASSIS AND BODY

Tire condition & inflation pressure (7)*	Check frequently and adjust or replace if necessary								
Wheel alignment (7)*	Inspect when abnormal condition is noted								
Steering wheel & linkage	I	I	I	I	I	I	I	I	I
Power steering fluid & lines (3)*	I	I	I	I	I	I	I	I	I
Drive shaft boots (8)*	I	I	I	I	I	I	I	I	I
Seat belts, buckles & anchors	I	I	I	I	I	I	I	I	I
Lubricate locks, hinges & bonnet latch	Check frequently and adjust or replace if necessary								
Wheel bearing grease	I	I	I	I	I	I	I	I	I
Propeller shaft grease - Front / Rear (9)*	I	I	I	I	I	I	I	I	I
Air conditioner filter (10)*	R	R	R	R	R	R	R	R	R
	Shorten the service interval under severe conditions								
Tailgate hinge spring	Apply grease when you hear a noise from the tailgate. Maintenance schedule: check the hinge spring at every 20000 km or 1 year (under severe conditions: check the hinge spring and lubricant frequently)								

Chart Symbols:

- I - Inspect these items and their related parts. If necessary, correct, clean, replenish, adjust or replace.
- R - Replace or change.
- (3)* Refer to "Recommended fluids and lubricants".
- (7)* If necessary, rotate and balance wheels.
- (8)* After completion of off-road operation, the drive shaft boots should be inspected.
- (9)* Inspect propeller shaft grease every 5000 km or 3 months if the vehicle is mainly driven under severe condition.
 - In off-road or dusty road, or
 - In heavy city traffic where the outside temperature regularly reaches 32°C (90°F) or higher, or
 - In hilly or mountainous terrain.

(10)* Severe Conditions in Air Conditioner Filter

- Pollutant area or off-road driving, extended air conditioner or heater operation
- In heavy city traffic where the outside temperature regularly reaches 32°C (90°F) or higher

Scheduled maintenance services (GEN) - D22DTR

* Use only approved KG Mobility genuine parts.

Maintenance service and record retention are the owner's responsibility. You should retain evidence that proper maintenance has been performed on your vehicle in accordance with the scheduled maintenance service chart.

* EU Countries: Only countries that belong to EU. (It does not apply to all countries in EU.)

MAINTENANCE ITEM	MAINTENANCE INTERVAL	Kilometers (miles) or time in months, whichever comes first								
		x1000 km	15	30	45	60	75	90	105	120
		x1000 miles	10	20	30	40	50	60	70	80
		Months	12	24	36	48	60	72	84	96

ENGINE CONTROL SYSTEM

Drive belt	I	I	I	I	I	I	I	I	I
* Engine oil & filter ** (1)* (3)* (4)* (11)*	R	R	R	R	R	R	R	R	R
	Initial check: 7500 km, and replenish if necessary. Shorten the service interval under severe conditions								
Cooling system hose & connections	I	I	I	I	I	I	I	I	I
Engine coolant (3)* (4)*	Change every 200000 km or 5 years. And, inspect and replenish if necessary.								
* Fuel filter (1)*	I	R*	I	R*	I	R*	I	R*	R*
	Draining water from fuel filter: whenever replacing the engine oil								
Fuel line & connections	I	I	I	I	I	I	I	I	I
Air cleaner (2)*	R	R	R	R	R	R	R	R	R
	Initial check: 7500 km, and clean if necessary. Check frequently and clean if necessary. Shorten the service interval under severe conditions								

Chart Symbols:

I - Inspect these items and their related parts. If necessary, correct, clean, replenish, adjust or replace.

*1 Check the engine oil level and leak every 3000 km (2000 miles) or before starting a long trip.

R - Replace or change.

- (1)* If vehicle is operated under severe condition: Shorten the service interval.
- Frequent stop-and-go traffic, extended idling, short driving distance below 6 km, driving distance below 16 km when the outside temperature remains below freezing
 - Driving in a hilly or mountainous terrain, sandy, or dusty area

- High load driving such as trailer towing

- Taxi, patrol service or delivery service (extended idling and excessive driving with low speed)

(2)* If vehicle is operated under severe condition, driving in dusty condition or sandy condition, pollutant area or off-road driving, frequently inspect the air cleaner, if necessary, change the air cleaner.

(3)* More frequent maintenance is required if under dusty driving condition.

(4)* Refer to "Recommended fluids, coolant and lubricants".

(11)* EURO5 or EURO6 emission regulation countries:
Initial change 15000 km (severe conditions: 7500 km)

* Use only approved KG Mobility genuine parts.

* EU Countries: Only countries that belong to EU. (It does not apply to all countries in EU.)

MAINTENANCE ITEM	MAINTENANCE INTERVAL	Kilometers (miles) or time in months, whichever comes first								
		x1000 km	15	30	45	60	75	90	105	120
		x1000 miles	10	20	30	40	50	60	70	80
		Months	12	24	36	48	60	72	84	96

CHASSIS AND BODY

Exhaust pipes & mountings	I	I	I	I	I	I	I	I	I
Brake / Clutch fluid (3)*	Change every 2 years (inspect frequently)								
Parking brake / Brake pads (Front & Rear) (4)*	I	I	I	I	I	I	I	I	I
Brake line & connections (including booster) (4)*	I	I	I	I	I	I	I	I	I
Manual transmission oil (5)*	Inspect and replenish every 60000 km or 3 years. (Severe driving condition: Change every 120000 km)								
Clutch & brake pedal free play	I	I	I	I	I	I	I	I	I
Transfer case fluid (3)*	Frequent check of oil leak								
	Front	I	R	I	R	I	R	I	R
Axle oil	Rear	I	R	I	R	I	R	I	R
Automatic transmission fluid (6)*	Inspect and replenish every 3 years/60000 km After that inspect every 30000 km, if necessary replenish and replace. (Inspect and replace every 60000 km under severe condition)								
Check play/tightness for lower bolt/nut and ball joint grease leak on chassis and body (6)*	Check frequently and adjust or replace if necessary								

Chart Symbols:

I - Inspect these items and their related parts. If necessary, correct, clean, replenish, adjust or replace.

R - Replace or change.

(3)* Refer to "Recommended fluids and lubricants".

(4)* More frequent maintenance is required if the vehicle is operated under any of the following conditions:

- In heavy city traffic where the outside temperature regularly reaches 32°C (90°F) or higher, or
- In hilly or mountainous terrain, or
- When doing frequent trailer towing, or
- Uses such as found in taxi, police or delivery service.

(5)* Inspect and replenish every 60000 km (or 3 years)

Normal driving condition: Fill for Life

(Severe driving condition: Change every 120000 km)

(6)* If vehicle is operated under severe condition: Shorten the service interval.

- Towing a trailer or off-road driving (Inspect the leak of fluid at any time, occasionally)
- Taxi, patrol service or delivery service (extended idling and excessive driving with low speed)
- Frequent stop-and-go traffic, extended idling, short driving distance
- Driving in a hilly or mountainous terrain, sandy, or dusty area
- Driving frequently at high speed over 170 km/hour
- Driving frequently in area where heavy traffic under the ambient temperature above 32°C

* Use only approved KG Mobility genuine parts.

* EU Countries: Only countries that belong to EU. (It does not apply to all countries in EU.)

MAINTENANCE ITEM	MAINTENANCE INTERVAL	Kilometers (miles) or time in months, whichever comes first								
		x1000 km	15	30	45	60	75	90	105	120
		x1000 miles	10	20	30	40	50	60	70	80
		Months	12	24	36	48	60	72	84	96

CHASSIS AND BODY

Tire condition & inflation pressure (7)*	Check frequently and adjust or replace if necessary							
Wheel alignment (7)*	Inspect when abnormal condition is noted							
Steering wheel & linkage	I	I	I	I	I	I	I	I
Power steering fluid & lines (3)*	I	I	I	I	I	I	I	I
Drive shaft boots (8)*	I	I	I	I	I	I	I	I
Seat belts, buckles & anchors	I	I	I	I	I	I	I	I
Lubricate locks, hinges & bonnet latch	Check frequently and adjust or replace if necessary							
Wheel bearing grease	I	I	I	I	I	I	I	I
Propeller shaft grease - Front / Rear (9)*	I	I	I	I	I	I	I	I
Air conditioner filter (10)*	R	R	R	R	R	R	R	R
	Shorten the service interval under severe conditions							
Tailgate hinge spring	Apply grease when you hear a noise from the tailgate. Maintenance schedule: check the hinge spring at every 15000 km or 1 year (under severe conditions: check the hinge spring and lubricant frequently)							

Chart Symbols:

- I - Inspect these items and their related parts. If necessary, correct, clean, replenish, adjust or replace.
- R - Replace or change.
- (3)* Refer to "Recommended fluids and lubricants".
- (7)* If necessary, rotate and balance wheels.
- (8)* After completion of off-road operation, the drive shaft boots should be inspected.
- (9)* Inspect propeller shaft grease every 5000 km or 3 months if the vehicle is mainly driven under severe condition.
 - In off-road or dusty road, or
 - In heavy city traffic where the outside temperature regularly reaches 32°C (90°F) or higher, or
 - In hilly or mountainous terrain.

(10)* Severe Conditions in Air Conditioner Filter

- Pollutant area or off-road driving, extended air conditioner or heater operation
- In heavy city traffic where the outside temperature regularly reaches 32°C (90°F) or higher

Scheduled maintenance services (under severe condition) - D22DTR

* Use only approved KG Mobility genuine parts.

Maintenance service and record retention are the owner's responsibility. You should retain evidence that proper maintenance has been performed on your vehicle in accordance with the scheduled maintenance service chart.

MAINTENANCE ITEM	MAINTENANCE INTERVAL	Kilometers (miles) or time in months, whichever comes first								
		x1000 km	7.5	15	22.5	30	37.5	45	52.5	60
		Months	6	12	18	24	30	36	42	48

ENGINE CONTROL SYSTEM

Drive belt	I	I	I	I	I	I	I	I	I
* Engine oil & filter *1 (1)* (3)* (4)*	R	R	R	R	R	R	R	R	R
Cooling system hose & connections	I	I	I	I	I	I	I	I	I
Engine coolant (3)* (4)	Change every 100000 km or 3 years. And, inspect and replenish if necessary.								
Fuel filter (1)*	I	I	R	I	I	R	I	I	
	Drain the water from fuel filter: whenever replacing the engine oil.								
Fuel line & connections	I	I	I	I	I	I	I	I	I
Air cleaner (2)*	R	R	R	R	R	R	R	R	R
	Shorten the service interval under severe conditions								

Chart Symbols:

I - Inspect these items and their related parts. If necessary, correct, clean, replenish, adjust or replace.

*1 Check the engine oil level and leak every 3000 km (2000 miles) or before starting a long trip.

R - Replace or change.

(1)* If vehicle is operated under severe condition:
Shorten the service interval.

- Frequent stop-and-go traffic, extended idling, short driving distance below 6 km, driving distance below 16 km when the outside temperature remains below freezing

- Driving in a hilly or mountainous terrain, sandy, or dusty area
- High load driving such as trailer towing

- Taxi, patrol service or delivery service (extended idling and excessive driving with low speed)

(2)* If vehicle is operated under severe condition, driving in dusty condition or sandy condition, pollutant area or off-road driving, frequently inspect the air cleaner, if necessary, change the air cleaner.

(3)* More frequent maintenance is required if under dusty driving condition.

(4)* Refer to "Recommended fluids, coolant and lubricants".

MAINTENANCE ITEM	MAINTENANCE INTERVAL	Kilometers (miles) or time in months, whichever comes first								
		x1000 km	7.5	15	22.5	30	37.5	45	52.5	60
		Months	6	12	18	24	30	36	42	48

CHASSIS AND BODY

Exhaust pipes & mountings		I	I	I	I	I	I	I	I
Brake / Clutch fluid (3)*		Change every 1 years (inspect frequently)							
Parking brake / Brake pads (Front & Rear) (4)*		I	I	I	I	I	I	I	I
Brake line & connections (including booster)		I	I	I	I	I	I	I	I
Manual transmission oil (5)*					I				I
Clutch & brake pedal free play		I	I	I	I	I	I	I	I
Transfer case fluid (3)*		I	I	I	R	I	I	I	R
Axle oil	Front	I	R	I	R	I	R	I	R
	Rear	I	R	I	R	I	R	I	R
Automatic transmission fluid (6)*					I				R
Check play/tightness for lower bolt/nut and ball joint on chassis and body (6)*		Check frequently and adjust or replace if necessary (change every 100000 km only ball joint)							

Chart Symbols:

- I - Inspect these items and their related parts. If necessary, correct, clean, replenish, adjust or replace.
- R - Replace or change.
- (3)* Refer to "Recommended fluids and lubricants".
- (4)* More frequent maintenance is required if the vehicle is operated under any of the following conditions:
- In heavy city traffic where the outside temperature regularly reaches 32°C (90°F) or higher, or
 - In hilly or mountainous terrain, or
 - When doing frequent trailer towing, or
 - Uses such as found in taxi, police or delivery service.

- (5)* Inspect and replenish every 30000 km (or 2 years)
Normal driving condition: Fill for Life

(Severe driving condition: Change every 120000 km)

- (6)* If vehicle is operated under severe condition: Shorten the service interval.

- Towing a trailer or off-road driving (Inspect the leak of fluid at any time, occasionally)
- Taxi, patrol service or delivery service (extended idling and excessive driving with low speed)
- Frequent stop-and-go traffic, extended idling, short driving distance
- Driving in a hilly or mountainous terrain, sandy, or dusty area
- Driving frequently at high speed over 170 km/hour
- Driving frequently in area where heavy traffic under the ambient temperature above 32°C

MAINTENANCE ITEM	MAINTENANCE INTERVAL	Kilometers (miles) or time in months, whichever comes first								
		x1000 km	7.5	15	22.5	30	37.5	45	52.5	60
		Months	6	12	18	24	30	36	42	48

CHASSIS AND BODY

Tire condition & inflation pressure (7)*	Check frequently and adjust or replace if necessary							
Wheel alignment (7)*	Inspect when abnormal condition is noted							
Steering wheel & linkage	I	I	I	I	I	I	I	I
Power steering fluid & lines (3)*	I	I	I	I	I	I	I	I
Drive shaft boots (8)*	I	I	I	I	I	I	I	I
Seat belts, buckles & anchors	I	I	I	I	I	I	I	I
Lubricate locks, hinges & bonnet latch	Check frequently and adjust or replace if necessary							
Wheel bearing grease	I	I	I	I	I	I	I	I
Propeller shaft grease - Front / Rear (9)*	I	I	I	I	I	I	I	I
Air conditioner filter (10)*	R	R	R	R	R	R	R	R
Tailgate hinge spring	Apply grease when you hear a noise from the tailgate. Maintenance schedule: check the hinge spring at every 7500 km or 6 months (under severe conditions: check the hinge spring and lubricant frequently)							

Chart Symbols:

I - Inspect these items and their related parts. If necessary, correct, clean, replenish, adjust or replace.

R - Replace or change.

(3)* Refer to "Recommended fluids and lubricants".

(7)* If necessary, rotate and balance wheels.

(8)* After completion of off-road operation, the drive shaft boots should be inspected.

(9)* Inspect propeller shaft grease every 5000 km or 3 months if the vehicle is mainly driven under severe condition.

- In off-road or dusty road, or

- In heavy city traffic where the outside temperature regularly reaches 32°C (90°F) or higher, or

- In hilly or mountainous terrain.

(10)* Severe Conditions in Air Conditioner Filter

- Pollutant area or off-road driving, extended air conditioner or heater operation

Scheduled maintenance services - G20DTR

* Use only approved KG Mobility genuine parts.

Maintenance service and record retention are the owner's responsibility. You should retain evidence that proper maintenance has been performed on your vehicle in accordance with the scheduled maintenance service chart.

MAINTENANCE ITEM	MAINTENANCE INTERVAL	Kilometers (miles) or time in months, whichever comes first								
		x1000 km	15	30	45	60	75	90	105	120
		x1000 miles	10	20	30	40	50	60	70	80
		Months	12	24	36	48	60	72	84	96

ENGINE CONTROL SYSTEM

Drive belt	I	I	I	I	I	I	I	I	I
Engine oil & engine oil filter (1)* (3)* (Initial check: 7500 km)	R**	R	R	R	R	R	R	R	R
Cooling system hose & connections	I	I	I	I	I	I	I	I	I
Engine coolant (3)*	Change every 200000 km or 5 years. And, inspect replenish if necessary.								
Fuel filter (2)*	Replace every 100000 km (if using poor quality of fuel, replace every 30000 km)								
Fuel line & connections	I	I	I	I	I	I	I	I	I
Air cleaner (2)*	I	R	I	R	I	R	I	R	I
	Initial check: 7500 km, and clean if necessary. Shorten the service interval under severe conditions								
Ignition timing	I	I	I	I	I	I	I	I	I
Spark plugs	Change every 60000 km or 3 years.								
Charcoal canister & vapor lines	-	-	I	-	-	I	-	-	-

Chart Symbols:

I - Inspect these items and their related parts. If necessary, correct, clean, replenish, adjust or replace.

R - Replace or change.

** - In order to secure engine long life and effective break-in, first oil (factory filled) would be recommended to drain within 10000 km.

(1)* If vehicle is operated under severe condition: short distance driving, extensive idling or driving in dusty condition, shorten the service interval.

(2)* If vehicle is operated under severe condition, pollutant area or off-road driving, driving in dusty condition or sandy condition, frequently inspect the air cleaner, if necessary, change the air cleaner.

(3)* Refer to "Recommended fluids and lubricants".

* Use only approved KG Mobility genuine parts.

* EU Countries: Only countries that belong to EU. (It does not apply to all countries in EU.)

MAINTENANCE ITEM	MAINTENANCE INTERVAL	Kilometers (miles) or time in months, whichever comes first								
		x1000 km	15	30	45	60	75	90	105	120
		x1000 miles	10	20	30	40	50	60	70	80
		Months	12	24	36	48	60	72	84	96

CHASSIS AND BODY

Exhaust pipes & mountings	I	I	I	I	I	I	I	I	I
Brake / Clutch fluid (3)*	Change every 2 years (inspect frequently)								
Parking brake / Brake pads (Front & Rear) (4)*	I	I	I	I	I	I	I	I	I
Brake line & connections (including booster) (4)*	I	I	I	I	I	I	I	I	I
Manual transmission oil (5)*	Inspect and replenish every 60000 km or 3 years. (Severe driving condition: Change every 120000 km)								
Clutch & brake pedal free play	I	I	I	I	I	I	I	I	I
Transfer case fluid (3)*	I	I	I	R	I	I	I	I	R
	Frequent check of oil leak								
Axle oil	Front	I	R	I	R	I	R	I	R
	Rear	I	R	I	R	I	R	I	R
Automatic transmission fluid (6)*	Inspect and replenish every 3 years/60000 km After that inspect every 30000 km, if necessary replenish and replace. (Inspect and replace every 60000 km under severe condition)								
Check play/tightness for lower bolt/nut and ball joint grease leak on chassis and body (6)*	Check frequently and adjust or replace if necessary								

Chart Symbols:

I - Inspect these items and their related parts. If necessary, correct, clean, replenish, adjust or replace.

R - Replace or change.

(3)* Refer to "Recommended fluids and lubricants".

(4)* More frequent maintenance is required if the vehicle is operated under any of the following conditions:

- In heavy city traffic where the outside temperature regularly reaches 32°C (90°F) or higher, or
- In hilly or mountainous terrain, or
- When doing frequent trailer towing, or
- Uses such as found in taxi, police or delivery service.

(5)* Inspect and replenish every 60000 km (or 3 years)

Normal driving condition: Fill for Life

(Severe driving condition: Change every 120000 km)

(6)* If vehicle is operated under severe condition: Shorten the service interval.

- Towing a trailer or off-road driving (Inspect the leak of fluid at any time, occasionally)
- Taxi, patrol service or delivery service (extended idling and excessive driving with low speed)
- Frequent stop-and-go traffic, extended idling, short driving distance
- Driving in a hilly or mountainous terrain, sandy, or dusty area
- Driving frequently at high speed over 170 km/hour
- Driving frequently in area where heavy traffic under the ambient temperature above 32°C

* Use only approved KG Mobility genuine parts.

* EU Countries: Only countries that belong to EU. (It does not apply to all countries in EU.)

MAINTENANCE ITEM	MAINTENANCE INTERVAL	Kilometers (miles) or time in months, whichever comes first								
		x1000 km	15	30	45	60	75	90	105	120
		x1000 miles	10	20	30	40	50	60	70	80
		Months	12	24	36	48	60	72	84	96

CHASSIS AND BODY

Tire condition & inflation pressure (7)*	Check frequently and adjust or replace if necessary							
Wheel alignment (7)*	Inspect when abnormal condition is noted							
Steering wheel & linkage	I	I	I	I	I	I	I	I
Power steering fluid & lines (3)*	I	I	I	I	I	I	I	I
Drive shaft boots (8)*	I	I	I	I	I	I	I	I
Seat belts, buckles & anchors	I	I	I	I	I	I	I	I
Lubricate locks, hinges & bonnet latch	Check frequently and adjust or replace if necessary							
Wheel bearing grease	I	I	I	I	I	I	I	I
Propeller shaft grease - Front / Rear (9)*	I	I	I	I	I	I	I	I
Air conditioner filter (10)*	R	R	R	R	R	R	R	R
	Shorten the service interval under severe conditions							
Tailgate hinge spring	Apply grease when you hear a noise from the tailgate. Maintenance schedule: check the hinge spring at every 15000 km or 1 year (under severe conditions: check the hinge spring and lubricant frequently)							

Chart Symbols:

- I - Inspect these items and their related parts. If necessary, correct, clean, replenish, adjust or replace.
- R - Replace or change.
- (3)* Refer to "Recommended fluids and lubricants".
- (7)* If necessary, rotate and balance wheels.
- (8)* After completion of off-road operation, the drive shaft boots should be inspected.
- (9)* Inspect propeller shaft grease every 5000 km or 3 months if the vehicle is mainly driven under severe condition.
 - In off-road or dusty road, or
 - In heavy city traffic where the outside temperature regularly reaches 32°C (90°F) or higher, or
 - In hilly or mountainous terrain.

(10)* Severe Conditions in Air Conditioner Filter

- Pollutant area or off-road driving, extended air conditioner or heater operation
- In heavy city traffic where the outside temperature regularly reaches 32°C (90°F) or higher

Scheduled maintenance services (under severe condition) - G20DTR

* Use only approved KG Mobility genuine parts.

Maintenance service and record retention are the owner's responsibility. You should retain evidence that proper maintenance has been performed on your vehicle in accordance with the scheduled maintenance service chart.

* EU Countries: Only countries that belong to EU. (It does not apply to all countries in EU.)

MAINTENANCE ITEM	MAINTENANCE INTERVAL	Kilometers (miles) or time in months, whichever comes first								
		x1000 km	7.5	15	22.5	30	37.5	45	52.5	60
		Months	6	12	18	24	30	36	42	48

ENGINE CONTROL SYSTEM

Drive belt	I	I	I	I	I	I	I	I	I
Engine oil & engine oil filter (1)* (3)*	R**	R	R	R	R	R	R	R	R
Cooling system hose & connections	I	I	I	I	I	I	I	I	I
Engine coolant (3)*	Change every 100000 km or 3 years. And, inspect replenish if necessary.								
Fuel filter (2)*	Replace every 50000 km (if using poor quality of fuel, replace every 15000 km)								
Fuel line & connections	I	I	I	I	I	I	I	I	I
Air cleaner (2)*	R	R	R	R	R	R	R	R	R
	Shorten the service interval under severe conditions								
Ignition timing	I	I	I	I	I	I	I	I	I
Spark plugs	Change every 30000 km or 2 years.								
Charcoal canister & vapor lines	-	-	I	-	-	I	-	-	-

Chart Symbols:

I - Inspect these items and their related parts. If necessary, correct, clean, replenish, adjust or replace.

R - Replace or change.

** - In order to secure engine long life and effective break-in, first oil (factory filled) would be recommended to drain within 10000 km.

(1)* If vehicle is operated under severe condition:

Shorten the service interval.

- Frequent stop-and-go traffic, extended idling, short driving distance below 6 km, driving distance below 16 km when the outside temperature remains below freezing

- Driving in a hilly or mountainous terrain, sandy, or dusty area

- High load driving such as trailer towing

- Taxi, patrol service or delivery service (extended idling and excessive driving with low speed)

(2)* If vehicle is operated under severe condition, pollutant area or off-road driving, driving in dusty condition or sandy condition, frequently inspect the air cleaner, if necessary, change the air cleaner.

(3)* Refer to "Recommended fluids and lubricants".

MAINTENANCE ITEM	MAINTENANCE INTERVAL	Kilometers (miles) or time in months, whichever comes first								
		x1000 km	7.5	15	22.5	30	37.5	45	52.5	60
		Months	6	12	18	24	30	36	42	48

CHASSIS AND BODY

Exhaust pipes & mountings		I	I	I	I	I	I	I	I
Brake / Clutch fluid (3)*		Change every 1 years (inspect frequently)							
Parking brake / Brake pads (Front & Rear) (4)*		I	I	I	I	I	I	I	I
Brake line & connections (including booster)		I	I	I	I	I	I	I	I
Manual transmission oil (5)*					I				I
Clutch & brake pedal free play		I	I	I	I	I	I	I	I
Transfer case fluid (3)*		I	I	I	R	I	I	I	R
Axle oil	Front	I	R	I	R	I	R	I	R
	Rear	I	R	I	R	I	R	I	R
Automatic transmission fluid (6)*					I				R
Check play/tightness for lower bolt/nut and ball joint on chassis and body (6)*		Check frequently and adjust or replace if necessary (change every 100000 km only ball joint)							

Chart Symbols:

- I - Inspect these items and their related parts. If necessary, correct, clean, replenish, adjust or replace.
- R - Replace or change.
- (3)* Refer to "Recommended fluids and lubricants".
- (4)* More frequent maintenance is required if the vehicle is operated under any of the following conditions:
- In heavy city traffic where the outside temperature regularly reaches 32°C (90°F) or higher, or
 - In hilly or mountainous terrain, or
 - When doing frequent trailer towing, or
 - Uses such as found in taxi, police or delivery service.

- (5)* Inspect and replenish every 30000 km (or 2 years)
Normal driving condition: Fill for Life

(Severe driving condition: Change every 120000 km)

- (6)* If vehicle is operated under severe condition: Shorten the service interval.

- Towing a trailer or off-road driving (Inspect the leak of fluid at any time, occasionally)
- Taxi, patrol service or delivery service (extended idling and excessive driving with low speed)
- Frequent stop-and-go traffic, extended idling, short driving distance
- Driving in a hilly or mountainous terrain, sandy, or dusty area
- Driving frequently at high speed over 170 km/hour
- Driving frequently in area where heavy traffic under the ambient temperature above 32°C

MAINTENANCE ITEM	MAINTENANCE INTERVAL	Kilometers (miles) or time in months, whichever comes first								
		x1000 km	7.5	15	22.5	30	37.5	45	52.5	60
		Months	6	12	18	24	30	36	42	48

CHASSIS AND BODY

Tire condition & inflation pressure (7)*	Check frequently and adjust or replace if necessary							
Wheel alignment (7)*	Inspect when abnormal condition is noted							
Steering wheel & linkage	I	I	I	I	I	I	I	I
Power steering fluid & lines (3)*	I	I	I	I	I	I	I	I
Drive shaft boots (8)*	I	I	I	I	I	I	I	I
Seat belts, buckles & anchors	I	I	I	I	I	I	I	I
Lubricate locks, hinges & bonnet latch	Check frequently and adjust or replace if necessary							
Wheel bearing grease	I	I	I	I	I	I	I	I
Propeller shaft grease - Front / Rear (9)*	I	I	I	I	I	I	I	I
Air conditioner filter (10)*	R	R	R	R	R	R	R	R
Tailgate hinge spring	Apply grease when you hear a noise from the tailgate. Maintenance schedule: check the hinge spring at every 7500 km or 6 months (under severe conditions: check the hinge spring and lubricant frequently)							

Chart Symbols:

I - Inspect these items and their related parts. If necessary, correct, clean, replenish, adjust or replace.

R - Replace or change.

(3)* Refer to "Recommended fluids and lubricants".

(7)* If necessary, rotate and balance wheels.

(8)* After completion of off-road operation, the drive shaft boots should be inspected.

(9)* Inspect propeller shaft grease every 5000 km or 3 months if the vehicle is mainly driven under severe condition.

- In off-road or dusty road, or

- In heavy city traffic where the outside temperature regularly reaches 32°C (90°F) or higher, or

- In hilly or mountainous terrain.

(10)* Severe Conditions in Air Conditioner Filter

- Pollutant area or off-road driving, extended air conditioner or heater operation

Checking the engine room

Diesel Engine (D22DTR)

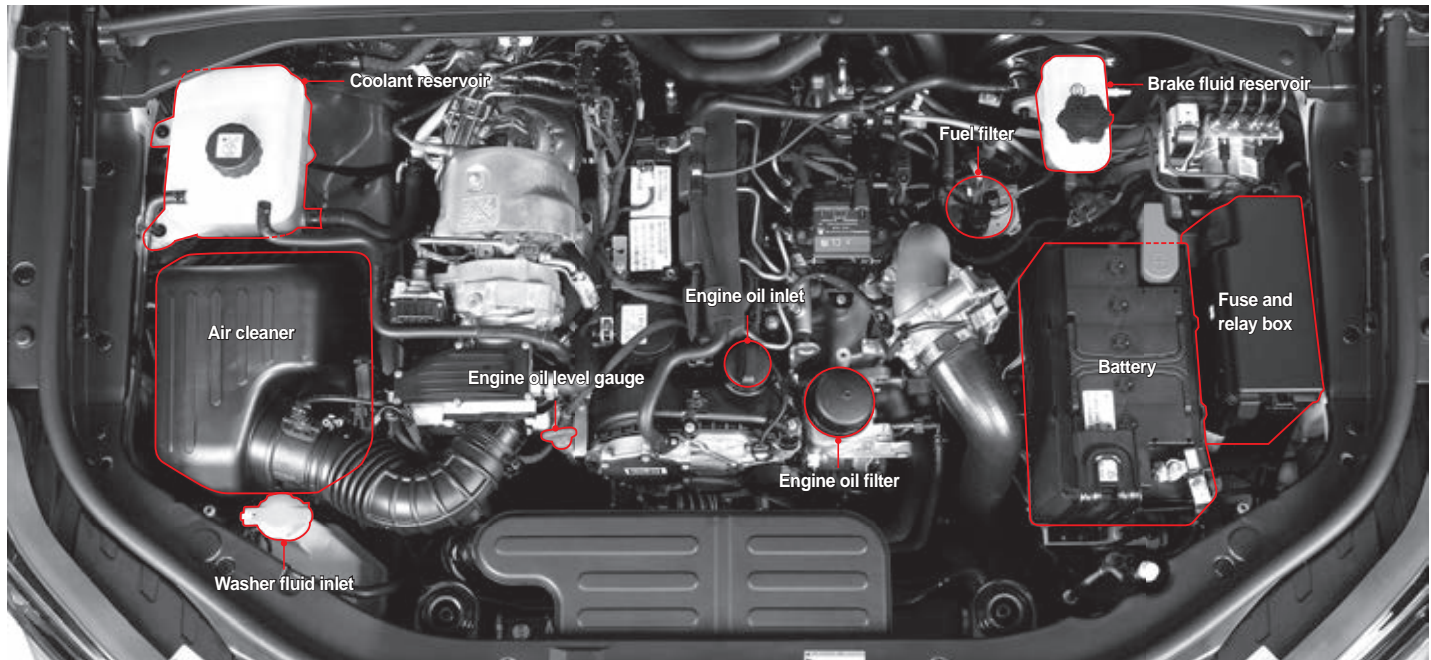

	경고 / WARNING / 경고 / ВНИМАНИЕ	21659-34001
	* 回転部に 손을 넣지 마십시오. * 엔진 시동중에는 팬이 작동합니다.	
	- Keep hand clear. - Fan blade start at eng running.	
	* 不要把手放进旋转部位上。 * 在发动机启动时，风扇会工作。	
	* ДЕРЖИТЕ РУККИ НА РАСТОЯНИИ * ЧАСТЕЙ ВЕНТЮТОРА ВРАЩАЮЩИХСЯ РАБОТАЮЩИМ ДВИГАТЕЛЕМ	

Warning

- After driving the vehicle, the systems including the engine, radiator, exhaust manifold, catalyst converter and exhaust pipe (muffler) are very hot, so caution should be taken when checking the engine room. Turn off and cool down the engine properly before checking in order to prevent a burn.
- There is a risk of serious injury from rotating parts such as the engine cooling fan when checking and working on the engine compartment. In addition, the cooling fan may rotate regardless of whether the engine is started or not.

Gasoline engine (G20DTR)

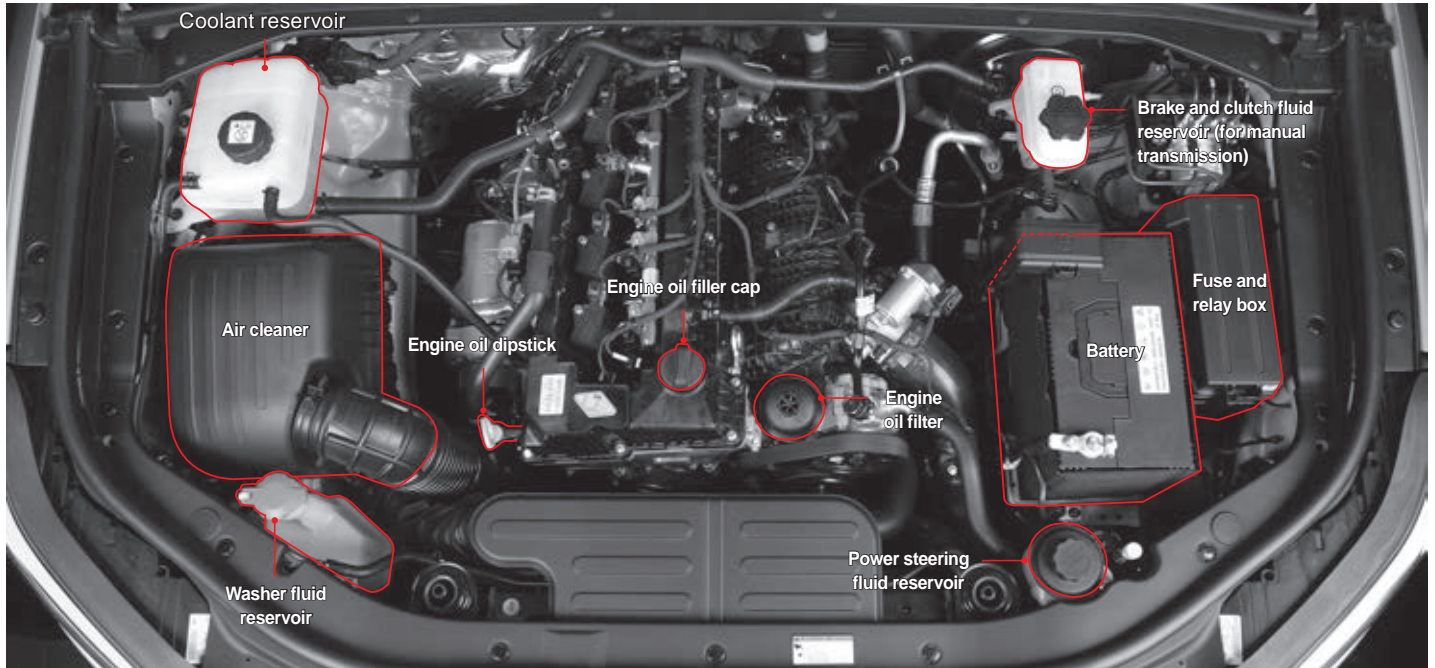

	경고 / WARNING / 警告 / ВНИМАНИЕ	21658-34001
	<ul style="list-style-type: none"> - 회전부에 손을 넣지 마십시오. - 엔진 시동중에는 팬이 작동합니다. 	
	<ul style="list-style-type: none"> - Keep hand clear. - Fan blade start at eng running. 	
	<ul style="list-style-type: none"> - 不要把手放进旋转部位上。 - 在发动机启动时，风扇会工作。 	
	<ul style="list-style-type: none"> - ДЕРЖИТЕ РУКИ НА РАСТОЯНИИ - ПОДАЛЖИ РУКИ ОТРАБАТОВАЮЩИХ РАБОТАЮЩИХ ДВИГАТЕЛЕЙ 	

Warning

- After driving the vehicle, the systems including the engine, radiator, exhaust manifold, catalyst converter and exhaust pipe (muffler) are very hot, so caution should be taken when checking the engine room. Turn off and cool down the engine properly before checking in order to prevent a burn.
- There is a risk of serious injury from rotating parts such as the engine cooling fan when checking and working on the engine compartment. In addition, the cooling fan may rotate regardless of whether the engine is started or not.

Engine oil

Diesel Engine

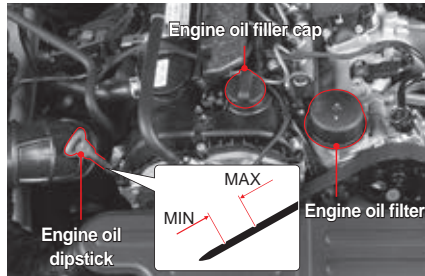

Gasoline Engine

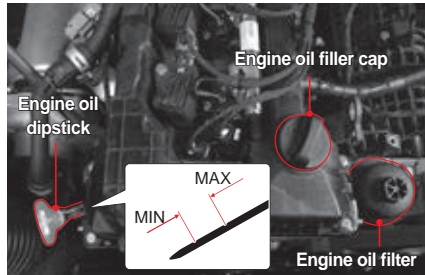

Level Check

Park the vehicle on a level ground and apply the parking brake.
Stop the engine and wait for more than 5 minutes.

- 1 Pull out the dipstick and wipe it out with a clean cloth. Reinsert it all the way.
- 2 Pull out it again and check the oil level.
- 3 The oil level should be between the maximum (Max) mark and minimum (Min) mark on the oil dipstick. Oil should be replenished before the level goes below the minimum mark.

Replenishment

- 1 If the level gets to the lower point, open the filter cap on top of the cylinder block and add the genuine oil without exceeding the level of the upper mark.
- 2 Recheck the oil level after 5 minutes.

! Caution

- Regularly check the engine oil level and add KG Mobility genuine engine oil if necessary.
- Clean the dipstick with clean cloth so that any foreign materials cannot get into the engine.
- The oil should not go above the upper mark on the dipstick.
- The engine oil may be consumed more if the engine is new.

! Warning

- Operating vehicle with insufficient amount of oil can damage the engine. Make sure the engine oil level is correct and add oil if necessary.

Function of engine oil

Engine oil's major function is to lubricate and cool the parts inside of the engine, which enables engine to work properly.

Consumption of Engine Oil

The consumption of engine oil is depending on the viscosity and quality of the oil, and the driving habit. More oil may be required under the following conditions;

- When the Vehicle is New

A new engine usually consumes more oil because its pistons, piston ring and cylinder walls are not yet adjusted with an optimal condition.

Oil Consumption : Max. 0.5 Liter per 1000 km

Accordingly, it is necessary for the driver to check frequently the oil level and to replenish oil if needed. KG Mobility Corporation recommends that the oil level be checked every time you refuel the vehicle or you drive the long distance until the first 5000 km.

- When driving at High Engine Speeds

As long as you keep the followings with sufficient care in your first running the vehicle, it will guarantee you to get excellent and comfortable performance for a long with your vehicle.

- Remember to check the engine oil level and shorten the cycle to refuel the engine oil under severe driving conditions.

- Avoid subjecting to engine to heavy loads by driving at full throttle, especially be careful when the outside temperature remains below freezing for the first 1000 km.
- Do not use the trailing in the first 1000 km driving

* What's Severe Driving Condition?

- Driving at the high engine speed or at high-speed
- Driving for consecutive two hours at high speed
- Driving the rough road, off-road, dirt-laden road, and muddy roads
- Driving in areas where salt or other corrosive materials are being used
- Repeated driving in short-distance
- Driving with the excessive idling
- High load driving such as trailing

Engine care

Observe the followings to keep the engine in good condition:

- Check the engine oil level frequently under severe driving condition and add some if necessary. The change interval should be shortened as well.
- Do not run a new engine at high speed until its driving distance gets 1000 km. Be extra careful when the engine is cold.
- After installing a new engine, do not tow another vehicle or a trailer until its driving distance gets 1000 km.

Change interval

- The engine oil filter element should be changed at the same time with the engine oil.
- Use only the KG Mobility genuine engine oil and filter.

Engine oil

Refer to Section "Scheduled maintenance services".

Engine oil filter

Service Interval
Same interval with the engine oil

Caution

- The service interval may be reduced if your vehicle is driven in rough conditions.
- Change the engine oil based on the driving distance or period, whichever comes first.

Specification and capacity

Service interval			
Specification	Diesel	EU	Quality class: KG Mobility genuine engine oil or ACEA C2 SAE 0W-30
		GEN	Quality class: KG Mobility genuine engine oil or ACEA C2 SAE 0W-30 or MB 229.51 SAE 5W-30
	Gasoline		Quality class: KG Mobility genuine engine oil or ACEA C2 SAE 0W-30 or MB 229.51 SAE 5W-30
Capacity	D22DTR	6.0 l	
	G20DTR	5.0 l	

Warning

- Use only KG Mobility genuine engine oil and filters. Use of nonrecommended products could cause damage to the engine.

Warnings and cautions when checking

Caution

- Regularly check the engine oil level and add the KG Mobility genuine engine oil if necessary.

Warning

- Clean the dipstick with a clean cloth so that any foreign materials cannot get into the engine.
- Use only the KG Mobility genuine engine oil.
- The oil should not go above the upper mark on the dipstick.
- Operating with insufficient or too much amount of oil can damage the engine.

SAE viscosity classes

The SAE classes (viscosity) should be selected in accordance with the average seasonal air temperature.

Applying the SAE classes exactly on the basis of the outside air temperatures would necessitate frequently changing the engine oil. The temperature limits for the SAE classes should therefore be regarded as reference temperatures and the actual air temperature may be higher or lower for a short period of time.

* How to check engine oil specification

Example:

0W, 5W, 10W, 15W, 20W, 25W **20, 30, 40, 50, 60**

Winter oil viscosity
(W: Winter)

Summer oil viscosity

- The numerical, for example SAE 10W, relates to viscosity at particular temperature and the alphabet "W" indicates the oil's suitability for colder temperature.
- For summer oil viscosity, higher numbers mean higher viscosities.

Notice

- **No separate washer fluid reservoir for the rear window is provided. The washer fluid is supplied from the washer fluid reservoir for the windshield.**

Engine

The viscosity should be selected according to outside temperature. Do not switch to a different viscosity in the event of brief temperature fluctuations.

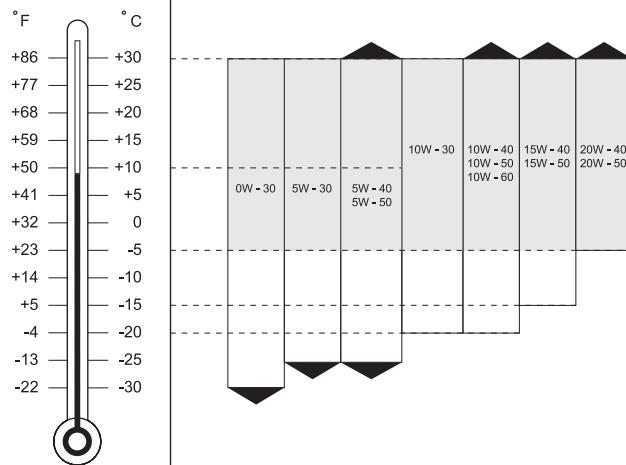

Engine coolant

Diesel Engine

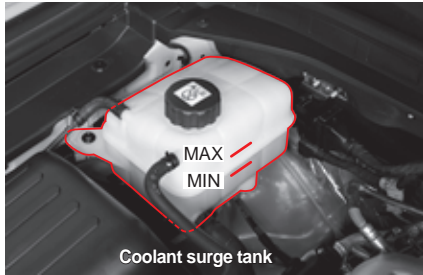

Gasoline Engine

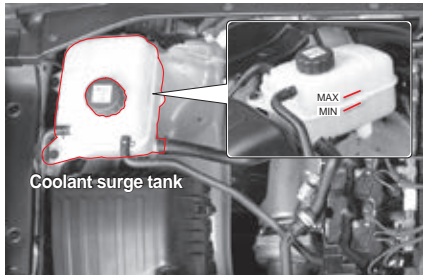

Level Check

Park the vehicle on level ground and apply the parking brake.
Stop the engine and wait until it cools.

- 1 The coolant level should be between the MAX and MIN mark on the coolant reservoir.
- 2 Check the coolant level. If the level is below the "MIN" mark, immediately add coolant.

Service Interval

- Replacement: Every 5 years or every 200000 km

Diesel Engine (D22DTR)	10.2ℓ	KG Mobility genuine coolant Anti-Freeze SYC-1025, Anti-Freeze:Water = 50:50
Gasoline Engine (G20DTR)	11.0ℓ	ORGANIC ACID TYPE, COLOR:BLUE

- Check: Everyday, before driving off
- Replenishment: Replenish as necessary

Warning

-  Do not remove the coolant reservoir cap when the engine and the radiator are hot. The cooling system may spray hot coolant if the cap is removed, causing serious injuries.
- Use only the KG Mobility genuine coolant and anti-freeze.

Replenishment

Use only the 50/50 mixture of soft water and antifreeze as specified.

- 1 Open the coolant surge tank cap slowly when the engine is cold. At this time, you can hear a “hissing” sound.
- 2 When there is no more “hissing” sound, remove the cap from the surge tank.
- 3 Add the 50:50 mixture of water and antifreeze to the coolant reservoir tank.
- 4 If no unusual things happen, tighten the coolant reservoir cap.



Caution

- Avoid any direct contact of the coolant to the painted body of the vehicle.



Caution

- An incorrect coolant mixture can result in severe malfunction or engine damage.
- Do not use a solution that contains more than 60% antifreeze or less than 35% antifreeze, which would reduce the effectiveness of the solution.
- Check the antifreeze mixture ratio after adding or replacing the coolant.

Notice

- If in doubt about the mix ratio, a 50% water and 50% antifreeze mix is the easiest to mix together as it will be the same quantity of each. It is suitable to use for most temperature ranges of -36°C (-33°F) and higher.
- The antifreeze mixture ratio at the time of vehicle delivery is 45%.



Warning

- When the coolant level is too low, the engine can overheat. If the coolant temperature gauge in the instrument cluster goes up abnormally, immediately check the coolant level. Use only the KG Mobility genuine coolant and anti-freeze. If different types of coolants or unapproved coolants are used to refill, chemical reactions can be caused and block the flow of the coolant. This may cause the engine to overheat or burning inside the engine.



Warning

- Scalding hot coolant and steam could be blown out under pressure, which could cause serious injury. Never remove the coolant surge tank cap when the engine and radiator are hot.
- Use only the Ssangyong genuine coolant and anti-freeze.

Air cleaner

Diesel Engine

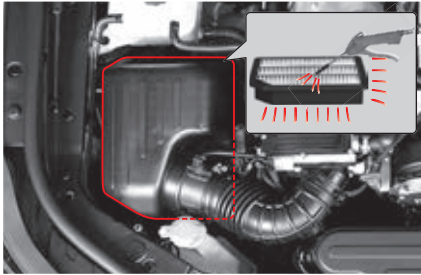

Gasoline Engine

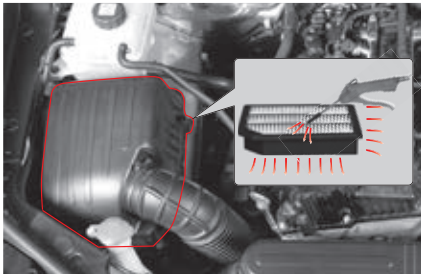

Cleaning

Refer to Section "SCHEDULED MAINTENANCE SERVICES".

Blow the compressed air through the element in the opposite direction to normal air flow to clean the element.

! Caution

- If you blow the compressed air to normal air flow, the engine will be damaged due to foreign materials entering.
- Be careful with the direction of the compressed air on the air cleaner.

! Caution

If vehicle is operated under severe condition

- Pollutant area or off-road driving
- Driving in dusty condition or sandy condition

frequently inspect the air cleaner, if necessary, change the air cleaner.

! Warning

- Do not drive your vehicle with an improperly installed air cleaner element or without it. It may damage the engine or may cause a fire.
- Do not let any object enter the housing when cleaning the air cleaner. It may damage the engine or may cause an engine to stall.

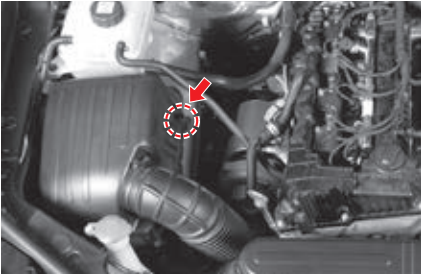

If the vehicle is operated in very dusty or sandy areas, replace more often than at the usual recommended intervals. If it is dirty, shake the element to remove dust. Clean the inside of the air cleaner housing and cover with a damp cloth.

Clean the air cleaner element by blowing compressed air through it in the opposite direction to normal air flow.



Warning

- Engine can be damaged.
- Do not operate the vehicle without air cleaner element.

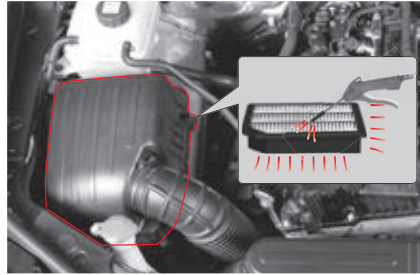

Blow the compressed air through the element in the opposite direction to normal air flow to clean the element as shown above.

Change

- 1 Open the clamp and remove the cover.
- 2 Replace the air cleaner element with a new one. Make sure that the element is correctly installed in the air cleaner housing.
- 3 Close the cover and close the clamp.

Fuel filter (D22DTR)

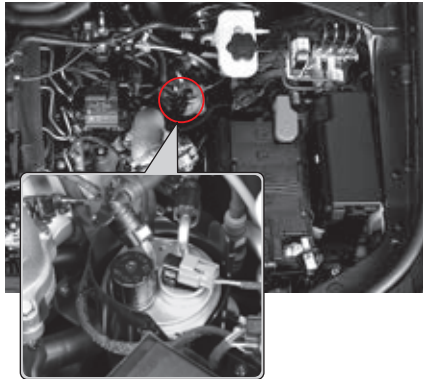

Priming Pump Operating Conditions

- 1 If the vehicle has been run out of fuel
- 2 After draining water from the fuel filter
- 3 After replacing the fuel filter

If this happens, pump fuel until the fuel filter is fully filled. Then, start the engine.

Warning

- After replacing the fuel filter or draining the water from the fuel filter, bleed the air from the fuel filter by using priming pump. Otherwise, the engine cannot be started or the fuel system could be damaged due to the air in fuel line.

Water Separating Function

If water in fuel gets into the engine and fuel system, it may cause serious damage to the fuel system. The fuel filter provides the water separating function to block the inflow of water. When the water level inside the water separator in the fuel filter exceeds a certain level, the warning light comes on and the buzzer sounds. If it occurs, have the system checked by KG Mobility Dealer or KG Mobility Authorized Service Center.

	Service interval
EU	Change every 40,000 km (Draining water from fuel filter: whenever replacing the engine oil)
General	Change every 30,000 km (Draining water from fuel filter: whenever replacing the engine oil)

Caution

- Change the fuel filter according to the specified service interval.

Operating the priming pump

Operating conditions

In any of the following cases, press the priming pump a number of times to fill the fuel filter with fuel until a certain amount of fuel comes out of the priming pump hole and then start the engine.

- When the whole amount of fuel is consumed so that the vehicle is refueled with the engine turned off
- When the water separation service from the fuel filter is carried out
- When the fuel filter is replaced

Warning

- After replacing the fuel filter or carrying out the water separation service, press the priming pump a number of times until a certain amount of fuel comes out of the priming pump hole. If you fail to press the priming pump properly, air may enter into the fuel line, causing the engine not to start or damaging the fuel system.

Operating method

- 1 With the priming pump pressed, turn it in the opening direction.

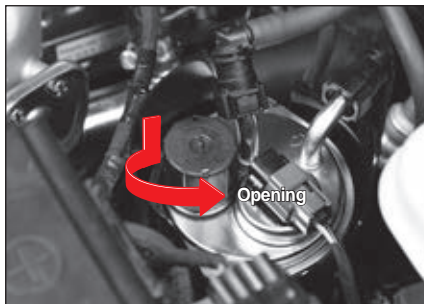

Caution

- Caution should be taken that opening or closing the priming pump using pliers may damage the priming pump.

- 2 With the priming pump opened, press it a number of times until a certain amount of fuel comes out of the priming pump hole.

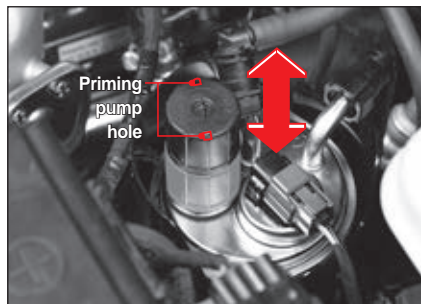

Warning

- When the priming pump operates, compressed fuel may be sprayed out from the priming pump hole instantaneously. Be careful not to allow the compressed fuel to come into contact with your eyes or other body parts.

- 3 With the priming pump pressed, turn it in the closing direction.

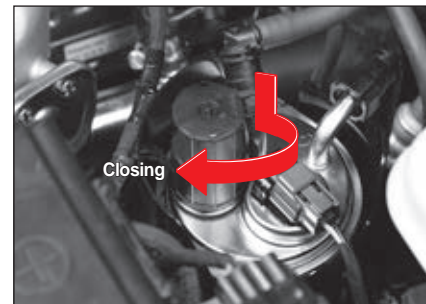

- 4 Close the engine hood and start the engine.

Brake and clutch fluid (with M/T)

Diesel Engine

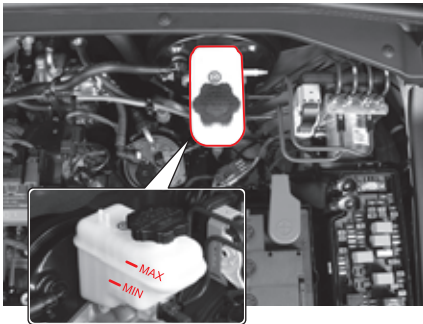

Gasoline Engine

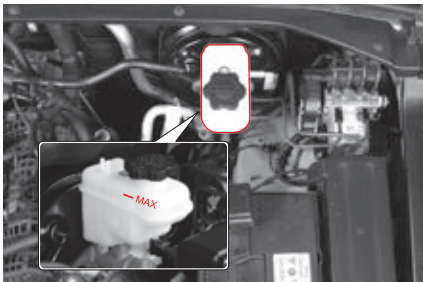

Specification and Replacement

Specification	DOT 4
Service interval	Every 2 years

Level Check and Replenishment

- The fluid level should be between the “MAX” and “MIN” levels on the reservoir.
- Check the level on a level surface. If it drops to or below the MIN mark, refill the tank with the specified fluid. Only use the specified fluid.

Caution

- Be careful not to let any foreign materials enter the tank when adding the fluid.
- Do not add the fluid above the “MAX” level.
- Do not allow the fluid to make contact with the body paintwork.
- After adding the fluid, tighten the cap securely.
- If frequent refills are required, have the system checked by a KG Mobility Dealer or KG Mobility Authorized Service Center.

Warning

- Use only the KG Mobility genuine brake fluid.
- Do not allow the fluid to make contact with skin or eyes. If contact happens, rinse affected areas immediately with plenty of water. If irritation persists, consult a doctor.
- The fluid gradually decreases according to brake pad wear. A sudden drop of the fluid level may indicate a leak in the system. In this case, have the system checked by a KG Mobility Dealer or KG Mobility Authorized Service Center.

Washer fluid

Top up washer fluid

Diesel Engine

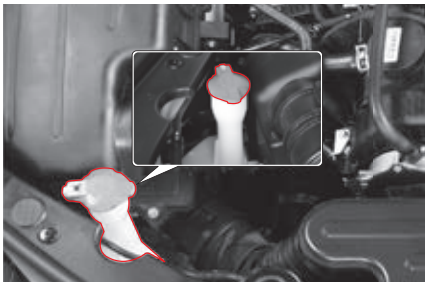

Gasoline Engine

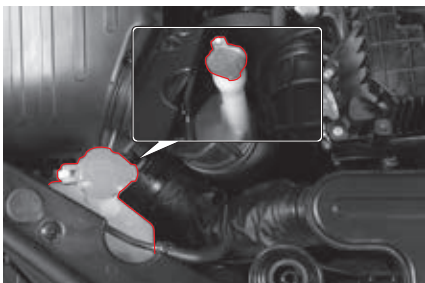

Frequently check the washer fluid level and add the specified product as needed.

In winter, use only the specified washer liquid for winter season.

Caution

- If you use plain water as washer fluid, it will freeze during the winter and damage the washer fluid reservoir and motor. Use only the specified washer fluid.
- If you operate the washer switch without washer fluid, the motor could be damaged due to overloads. Therefore, if there is no washer fluid, do not operate the washer motor.
- Operating the wipers on a dry surface on the windshield or rear window without any washer fluid may cause damage to the glass. Operate the wipers after sufficiently spraying the washer fluid.
- Avoid any spills of washer fluid on the engine or body paint of your vehicle during replenishment. If washer fluid spills onto your hand or other body part, wash it away under a clean water flow.
- There is no independent washer reservoir for the tailgate window. The front washer reservoir is also for the tailgate window.

Warning

- The washer fluid includes flammable materials to prevent freezing. It could cause a fire when directly contacted with flames. When checking the washer fluid, avoid the flames near the washer fluid tank.
- If engine oil or antifreeze is used as the washer fluid, it will decrease your visibility through the windshield and may cause an accident.

Power steering fluid

Diesel Engine

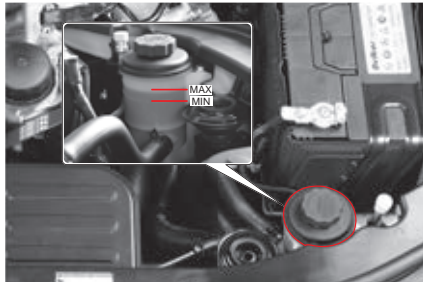

Gasoline Engine

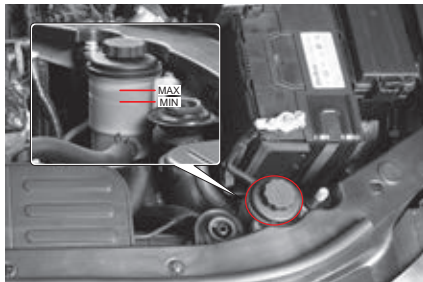

Check the fluid level on a level ground with the engine turned off. The fluid level should be between the MIN and MAX marks on the reservoir cap gauge. If it drops to or below the MIN mark, refill the reservoir with the specified fluid. Only use the specified fluid. The difference between the MIN and MAX marks shows fluctuations of the steering fluid between when it is hot and when it is cold.

Specification and Capacity

Specification	S-PSF4
Capacity (L)	Approx. 1.1 See NOTE 1: TOTAL FLUIDE DA (Extreme cold condition only)

NOTE 1: Super multigrade fluid with an exceptionally high viscosity index and a very low pour point, allowing functionality of hydraulic systems at extremely low temperatures. Excellent lubricating properties even at very low and very high temperatures.

Notice

- In severe cold weather, the viscosity of the power steering oil increases, which can cause temporary abnormal noise at engine start-up.

Battery

Diesel Engine

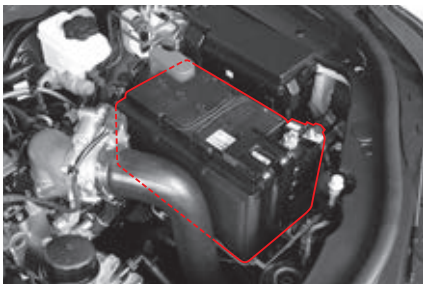

Gasoline Engine

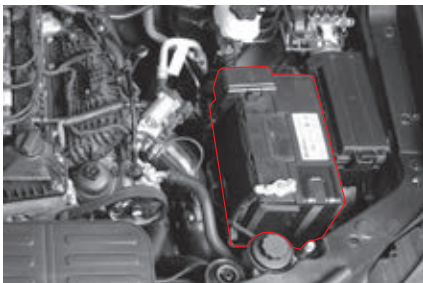

When the battery charge warning light () on the instrument cluster comes on, the battery is not normally charging. If the warning light comes on while driving, turn off all unnecessary electrical devices and have the system checked by a KG Mobility Dealer or KG Mobility Authorized Service Center.

Battery Maintenance

- Make sure the terminal connections are securely tightened.
- If the terminals are corroded, clean them with a wire brush or sand paper.
- The battery terminal should be disconnected only when the ignition key is removed from the key cylinder. Disconnecting the terminal with the key in the “ON” or “ACC” position may cause a sudden change in voltage and damage various electrical systems.
- Check the battery for any cracks, damages or leaks. Replace it if necessary. To remove any battery fluid on the battery surface, wear rubber gloves and wipe the fluid out with a wet-soapy cloth.

Specification

	Non-ISG	ISG
Specification	MF / 12V - 90AH	AGM / 12V - 80AH
Capacity	90AH	80AH





Caution

- If you disconnect the battery terminal when the engine is running, electrical systems could be damaged.
- To remove the battery cable, disconnect the negative cable first and be careful on the battery terminal polarity when you connect the cables. The negative and the positive should not be confused.
- The polarity of the battery, i.e. the connections for positive and negative cables, must not be interchanged. Never short-circuit the battery.
- When the ambient temperature is too low, the battery capacity will drop and can be frozen.
- Keep the battery electrolyte at its specified level. If the electrolyte level is higher than the MAX level, it can overflow during battery charging and if the electrolyte is overcharged, the battery can explode.
- Only use a battery with the approved voltage and capacity. Otherwise, an incompatible battery can catch fire.

 **Warning**

- The battery has acid that can burn you. And its gas can explode. You can get serious injuries if you are not careful. Keep naked flames, sparks and smoking items away from the battery.
- Loosely connected batter terminals can set up sparks. These sparks can cause a fire with flammable gas. Therefore, tightly connect the terminals.
- At night, if you need to check the engine room, do not use a lighter, but only use a battery-powered flashlight.
- Because the battery electrolyte is very strong acid, avoid any direct contact of the battery electrolyte on your skin or vehicle's body. If the acid contacts your skin, thoroughly wash your skin with fresh water and see your doctor. Do the same on your vehicle.
- Wear eye protection when working with a battery. If working in a closed area, keep good ventilation.

 **Warning**

- Always use the battery with correct voltage for the vehicle. Otherwise, there is a risk of fire.
- Observe the indications on the battery.
 -  Always read the safety instructions in the User Manual before working on the battery.
 -  The battery cell always contains highly flammable hydrogen gas which may explode if ignited. Be sure to keep it away from a cigarette, a spark or other flames.
 -  Wear a protective goggle when charging the battery or performing any work. In addition, ensure adequate ventilation of the enclosed space.
 -  The battery electrolyte solution contains a highly corrosive sulfuric acid. Be careful not to contact it with skin, eyes, clothes or paint. In particular, keep out of the children's reach.



When in contact with the skin, wash off the contact area; In case of eye contact, flush with running water for at least 15 minutes, and seek medical help immediately.



The hydrogen gas in the battery is highly flammable and may explode if ignited.



Do not throw out used battery as this pollutes the environment and is hazardous to our health. For environmental protection, used, properly dispose of used battery at designated disposal sites only.

Spark plugs - Gasoline engine



Spark plugs should be inspected periodically for carbon deposits. When carbon accumulates on a spark plug, a strong spark may not be produced.

Do not clean the electrodes with a fine wire brush and carefully scrape the carbon off the insulator with a small file. The spark plugs should then be blown clean with compressed air and the upper insulator wiped clean. Do not adjust the spark plug gap.

Service Interval

Replacement (G20DTR)	Change every 60,000 km
-----------------------------	------------------------

Specification (G20DTR)	NGK	SILKAR8H9G
	Gap	0.9 ± 0.1 mm

Caution

- When replacing the spark plugs, disconnect the negative terminal of the battery and turn off all the switches.
- It is recommended that the engine be cool or cold when changing the spark plugs (you could burn yourself).
- Do not use non-recommended spark plugs.
- Do not allow contaminants to enter spark plug hole.

Warning

- Spark plugs may be very hot. Be careful not to burn yourself.

Checking the wipers and replacing the blade

Replacing the blade of windshield wiper

- 1 Lift the wiper arm up with the engine turned off.

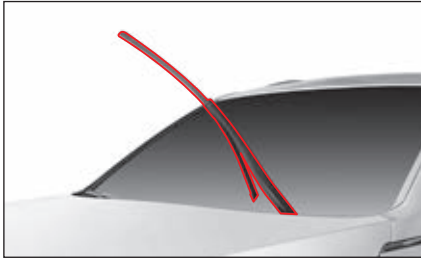

- 2 Press the wiper blade retainer (1) and pull the wiper blade out in the arrow direction (2).

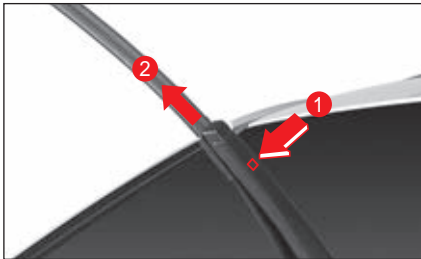

- 3 Insert a new wiper blade.
- 4 Put the wiper arm down.

Specifications of wiper blade

Windshield wiper	
Driver seat side	Front passenger seat side
650 mm	500 mm
26 "	20 "

Warning

- If there is a problem in wiper operation, it can be a fatal obstacle to safe driving when it rains or snows. Never drive the vehicle on a snowy day or a rainy day if the wiper does not operate.
- Holding the wiper arm or placing your hand near the operating part when the wiper is operating may cause an injury.

Caution

- Do not open the engine hood with the wiper lifted up. Doing so may damage the engine hood and the wiper.
- Do not operate the wiper when the windshield is dry.
- Do not wipe the windshield or the rear window with a towel stained with oil or wax. If the windshield or the rear window is stained with oil or wax, an abnormal noise may occur when you operate the wiper or light is reflected at night, making you unable to see the front well.
- When you check the wipers, be sure to lift the driver seat side wiper arm up first and then lift the front passenger seat side wiper arm up.
- When you lift the driver seat side wiper arm up, it may interfere with the front passenger seat side wiper arm, but that is normal.

Checking and replacing fuses and relays

If an electrical system does not operate normally, check the relevant fuse first. If the fuse is blown, replace it with a fuse of the same capacity.

Warning

- Not using a bulb or using a bulb with the capacity that does not meet the specifications or modifying the HID bulb or LED lamp wiring arbitrarily may cause the fuse disconnection, malfunction or damage other wiring-related devices.



Caution

- Removing a fuse while the electricity is being supplied may damage the relevant electrical system. Be sure to replace a fuse after turning off all electrical systems and the engine.
- Replace the fuse with a new one of the same capacity that meets the specifications.
- If the replaced fuse is blown continuously, have your vehicle checked and serviced at a KG Mobility authorized service center.

Notice

- Refer to the label attached to the fuse and relay box cover for the capacity and name of fuse.

Engine compartment fuse and relay box

- 1 Open the engine hood.
- 2 Lift the fuse box cover up  by pushing locking lever at each side .

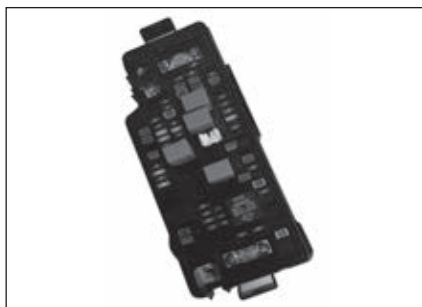
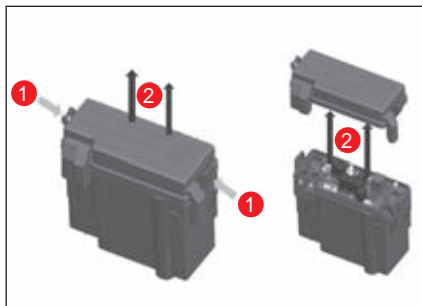

Interior fuse box

Open the driver seat door and open the interior fuse box by inserting your finger on the groove of the interior fuse box cover  and pulling it.

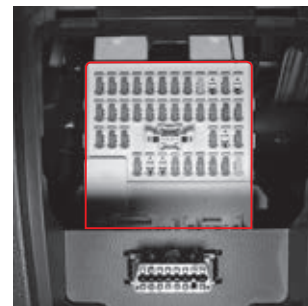

Checking and replacing fuses

- 1 Turn off all electrical systems and the engine.
- 2 Open the cover of the engine compartment fuse box cover or the interior fuse box.
- 3 Check the relevant fuse by referring to the block diagram of the fuses shown inside of the fuse box cover.
- 4 Pull out the relevant fuse by using the fuse puller.

The fuse puller is provided in the engine compartment fuse box.

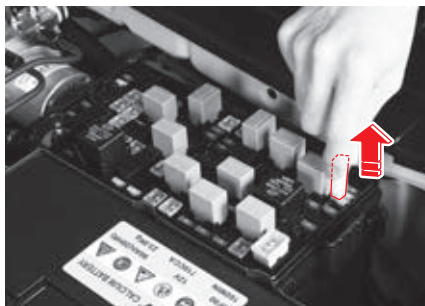

- 5 Check visually whether the fuse is blown or not.
- 6 If the fuse is normal, insert it back to its original position.
- 7 If the fuse is blown, check the capacity indicated on top of the fuse and replace it with a new fuse of the same capacity.

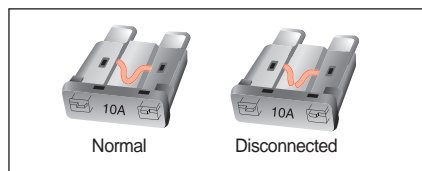
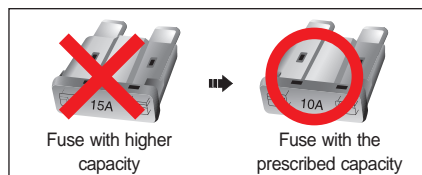

Warning

- Using steel wire, copper wire or aluminum foil instead of the fuse may cause a fire due to the overload of the electrical system. Always use a fuse with the prescribed capacity.
- Never use a fuse with a capacity higher than the prescribed capacity indicated on the fuse and relay box since a fuse with higher capacity may damage electrical systems or cause a fire.
- When the fuse is disconnected, use a normal fuse with the prescribed capacity.

Notice

- Spare fuses for each capacity are provided in the fuse and relay box. If you use a spare fuse, replenish with a new one immediately. The capacity is indicated on top of the fuse.

Checking and replacing the lamps

Specifications of lamps and checking

Specifications and quantity of lamps and bulbs

Components			Quantity	Specification	
Front side	Head-lamp (Type A)	High beam	-	LED	
		Low beam	-	LED	
		Turn signal lamp/ Side-marker lamp/ DRL	-	LED	
	Head-lamp (Type B)	High beam		2	H1-55W
		Low beam	Bulb	2	H7-55W
			HID*		D8S 25W
		Turn signal lamp/ Side-marker lamp/ DRL		-	LED
	Head-lamp (Type C)	High beam/Low beam (Integral)		2	H4 60W/55W
		Turn signal lamp		2	PY21W
		DRL/Side marker		2	21W/5W
	Front fog light	Bulb	2	H16	
		LED	-	LED	
	Side repeater (Secondary turn signal lamp)		-	LED	
	Puddle lamp		-	LED	

※ Headlamp (Type A): 4-lamp type

Headlamp (Type B): 2-lamp type

Components			Quantity	Specification	
Rear side	Rear lamp (Type A)	Tail (stop) lamp	-	LED	
		Turn signal lamp	2	PY21W	
		Backup lamp	2	W16W	
	Rear lamp (Type B)	Tail (stop) lamp	4 (2)	P21/5W	
		Rear fog light (OPT)	(2)	21W	
		Turn signal lamp	2	PY21W	
	Backup lamp		2	W16W	
License plate lamp		2	W5W		
Interior lamp	Front room lamp		LED	-	LED
			Bulb	2	W10W
	Center room lamp		LED	-	LED
			Bulb	2	W8W
	Glove box lamp		1	W5W	
	Sun visor lamp		2	W5W	
Front/rear door courtesy lamp		2	W5W		

※ Rear lamp (Type A): Except Rear Fog Specification

Rear lamp (Type B): "()" Apply to Rear Fog Option

Checking the lamps

Operate the ON/OFF switch of various lamps to see if the lamp turns on or off normally.

If the lamp does not turn on, check the lamp in the following order and replace the relevant part if it is abnormal.

- Fuse
- Bulb

If the fuse and the bulb are normal, have your vehicle checked and serviced at a KG Mobility authorized service center.



Caution

- Only use a bulb with the prescribed capacity when replacing the lamp.
- Be sure to disconnect the negative (-) battery cable or turn off the engine before replacing the lamp.
- Removing the lamp cover forcibly may damage the lamp cover so that it may not be used again, so caution should be taken when removing the lamp cover.
- Before replacing a bulb, be sure to turn off the relevant lamp and the engine.
- Do not touch the bulb with your hands during or right after bulb operation since there is a possibility of a burn.
- Holding the glass part of the bulb with your hand may leave a fingerprint, dust or moisture on the bulb, reducing its life or exploding it. In such case, wipe the glass part with a soft cloth.
- Be sure to have the aiming angle of the head lamp adjusted by a KG Mobility authorized service center.
- The internal surface of the head light and braking light lamp may be fogged temporarily under conditions such as rain or car washing. This is dew condensation according to a temperature difference between the inside and the outside of the lamp and it is not a functional problem. However, if water enters into the lamp or a large water drop occurs inside the lamp, contact a KG Mobility authorized service center.
- To replace an exterior lamp bulb, visit a KG Mobility authorized service center.

Position of exterior lights and lamps

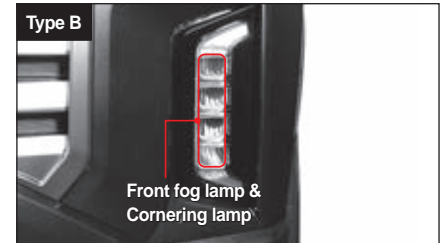
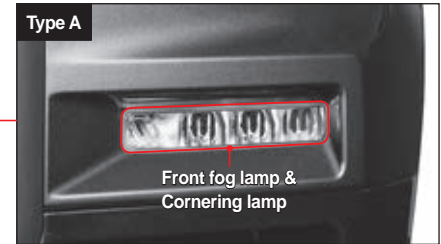
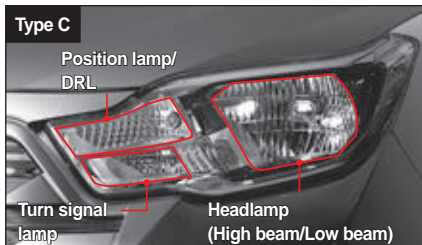
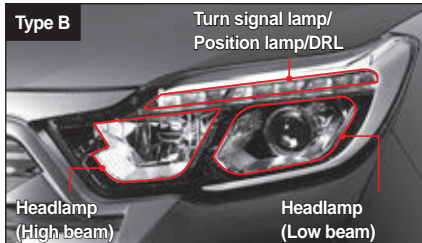
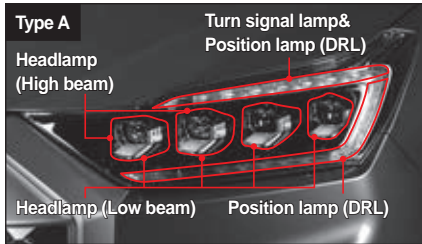

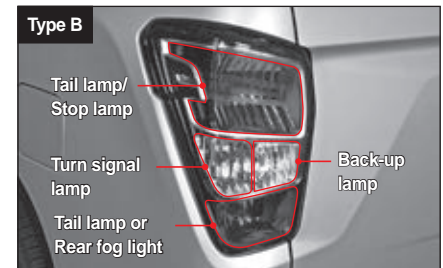
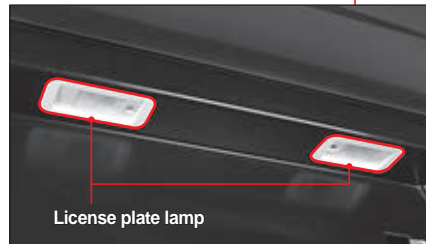
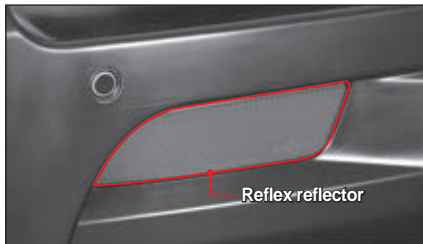
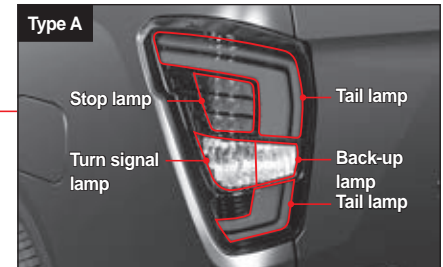
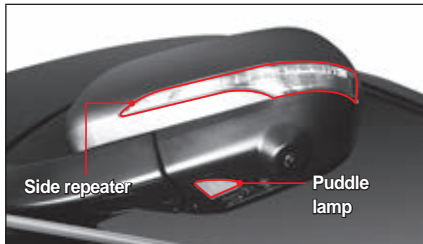

Characteristics of a HID head lamp

- The HID (high intensity discharge) head lamp bulb has better performance and longer durability than a regular (halogen) bulb, but frequent ON/OFF switching may shorten the life of the bulb.
- Unlike the regular (halogen) bulb, the HID head lamp bulb turns on and dims slowly when it is turned on after it is burned out. Therefore, if the HID head lamp turns off and comes on again when you turn on the switch, the HID head lamp bulb should be replaced.
- The HID head lamp has more complicated structure than the normal (halogen) head lamp, so additional cost is applied when replacing it.
- When the HID head lamp bulb and unit are separated or installed, the angle of the head lamp (up, down, left and right) should be adjusted as required. Request a KG Mobility authorized service center for help.

☞ Refer to "Adjusting the angle of the head light" (p.3-35)

Notice

Information regarding the characteristics of a HID head lamp

- The color of the light changes until the bulb is stabilized (approximately 4 seconds) when it is turned on initially.
- The color of the light changes according to the hours of use and this is the unique characteristic of the HID bulb.
 - Initial stage: Light yellow
 - Over 100 hours: Light blue
 - Over 1,000 hours: Blue
 - Later stage: Scarlet, purple, getting dark



Warning

- Never separate, disassemble and replace any components of the HID head lamp (projector, high voltage cable, ballast). Doing so may cause an electric shock, resulting in a serious injury.
- In a vehicle equipped with the HID head lamp, high voltage current flows on the lamp and relevant systems, so there is a possibility of an electric shock if any body part comes into contact with the lamp and relevant systems.
- Do not modify a vehicle not equipped with a HID head lamp arbitrarily to install a HID head lamp. Doing so may cause vehicle trouble due to the performance degradation of the relevant part or overload and block the vision of a driver in an oncoming vehicle, resulting in a fatal accident.
- The HID type lamp has a risk of electric shock due to high voltage, so be sure to check and replace it at a KG Mobility authorized service center.
- For a vehicle equipped with a HID head lamp, adjust the angle of the head light properly according to the number of occupants and luggage status in the vehicle and not to block the vision of a driver in an oncoming vehicle.



Caution

- If the HID head lamp type head light (low beam) does not turn on when it is activated, the relevant system should be checked more comprehensively than simple bulb, fuse or relay replacement. Have your vehicle checked at a KG Mobility authorized service center.

Replacing exterior lamps

All lamps except for the following lamps should be checked and replaced at a nearby KG Mobility authorized service center.

- Rear turn signal lamp
- Backup lamp

Warning

- Replacing with a lamp that does not meet the specifications may cause the disconnection of a fuse, malfunction or a fire.
- Before replacing the lamp, park the vehicle at a safe place, turn off the engine and disconnect the negative (-) battery cable. (After connecting the battery again, reset some functions of the vehicle.)
- Do not touch the bulb with your hands during or right after bulb operation since there is a possibility of a burn.

Caution

- When you install the lamp again after replacing it, install the socket firmly to the hole by turning it clockwise.
- Be sure to use genuine parts for the lamp.
- Do not install an additional lamp or LED for the lamps installed previously on the vehicle.

Replacing the rear turn signal lamps

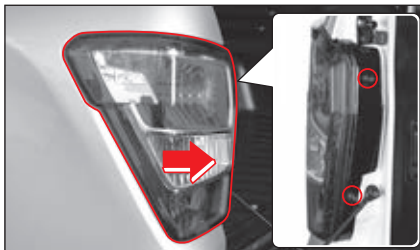

- 1 Disconnect the battery (-) terminal and remove the two mounting bolts (10mm) for the rear combination lamp. Pull the lamp assembly in the direction indicated by the arrow in the picture to disconnect the connector and detach the lamp.

Caution

- Be careful not to damage the painted surface of the vehicle body or rear combination assembly when removing it.

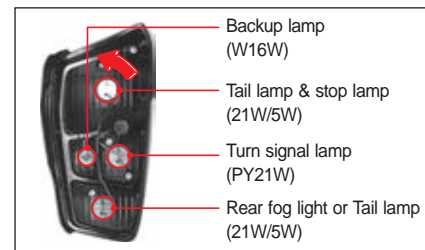

- 2 Turn the socket counterclockwise to remove the it.

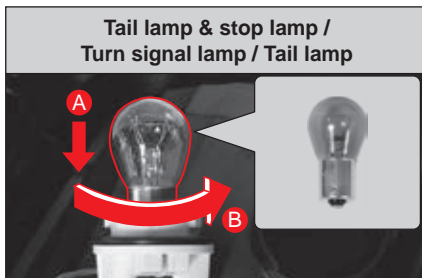

- 3 Remove the lamp from the removed socket by rotating the lamp in the direction of the arrow (B) while pressing it in the direction of the arrow (A).
- 4 Install in the reverse order of removal.



- 5 Pull the rear fog light or stop lamp in the direction of the arrow from the removed socket.
- 6 Install in the reverse order of removal.

Position of interior lamps

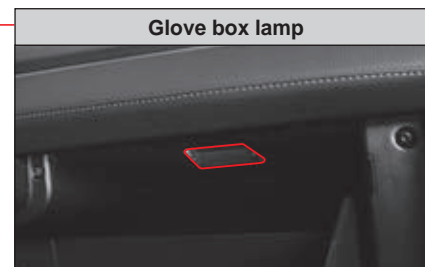
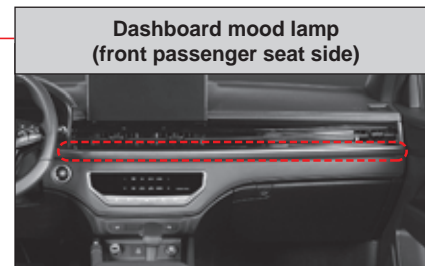
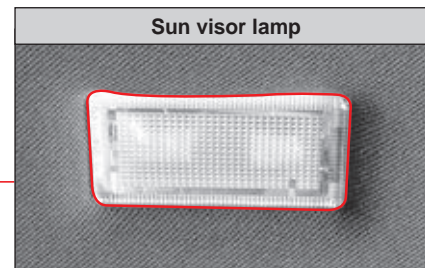
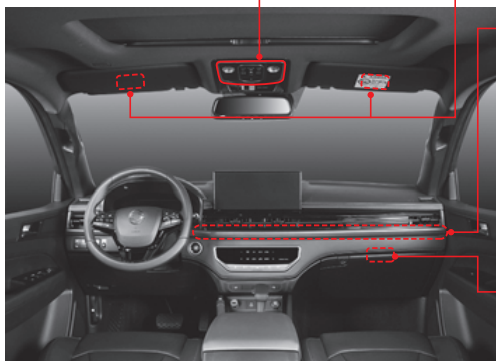
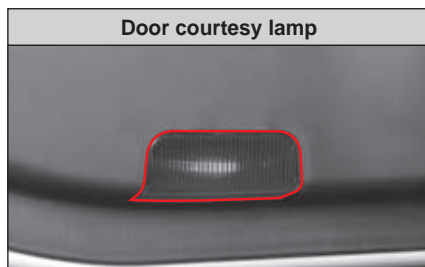
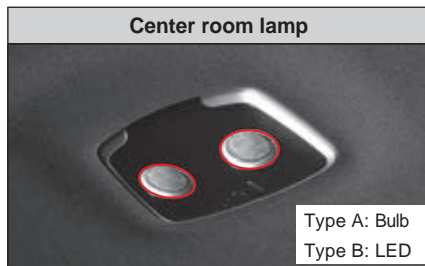
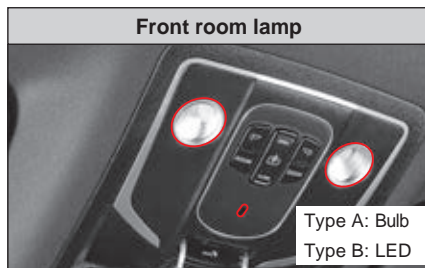

Replacing the interior lamps

Center Room Lamp

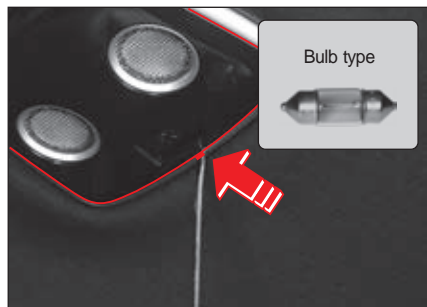

- 1 Turn the room lamp switch OFF, and remove the cover using a flat bladed screwdriver.

Caution

- When removing the cover, make sure to remove the front part of the cover first (marked with arrows). If you remove the rear part of the cover first, the cover may be damaged.



- 2 Remove the lamp by pulling it down (arrow direction) and replace it with a new one.
- 3 Fit the cover.

Door Courtesy Lamp

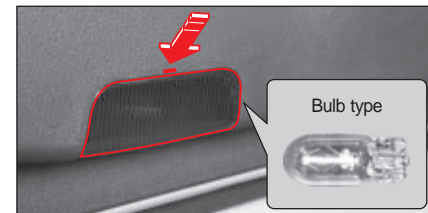

- 1 Disconnect the negative battery cable and remove the cover using a flat bladed screwdriver.

Caution

- When removing the cover, make sure to remove the top of the cover first (marked with arrows). If you remove the bottom part of the cover first, the cover may be damaged.



- 2 Remove the lamp by pulling it (arrow direction) and replace it with a new one. Keep the surface of the bulb free of foreign matter.
- 3 Fit the cover.

Sun Visor Lamp

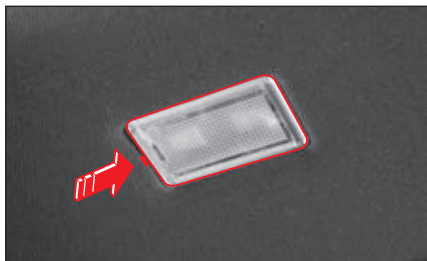

- 1 Turn the ignition switch OFF, and remove the cover using a flat bladed screwdriver.

Glove Box Lamp

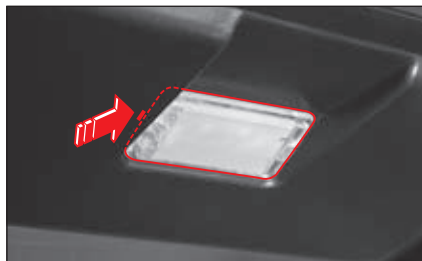

- 1 Disconnect the negative battery cable and remove the cover using a flat bladed screwdriver.

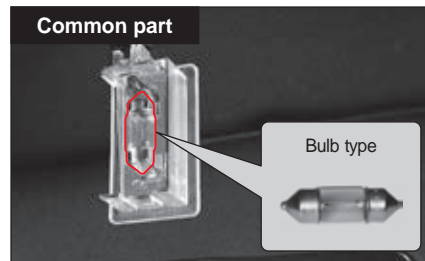

- 2 Remove the lamp.
- 3 Replace the bulb with a new one. Keep the surface of the bulb free of finger print for foreign matter.
- 4 Fit the cover.

Caution

- When removing the cover (sun visor lamp, glovebox lamp, driver/passenger lamp), remove the part with arrow mark first. Otherwise, the cover and connectors can be damaged.

Replacing the A/C filter

In any of the following cases, replace the A/C filter even if the replacement interval has not come near.

- If an unpleasant smell comes out when you operate the A/C after it is not operated for a long period of time
- If the cooling and heating performance or air blowing performance is lowered

Caution

- Replace the A/C filter every 10,000 km. However, if the vehicle is driven on a road where the air is heavily polluted, an unpaved road or the A/C and the heater are used excessively, replace the A/C filter earlier than the replacement interval.
- If the A/C filter is contaminated, the cooling performance may be lowered and an unpleasant smell may occur when you operate the A/C.
- Be careful not to switch the installation direction when replacing the A/C filter.

- 1 Open the glove box by pressing the open switch.

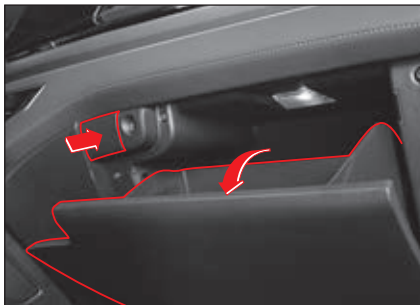

- 2 Pull the fixing holder on the left side and the right side of the glove box in the arrow direction.

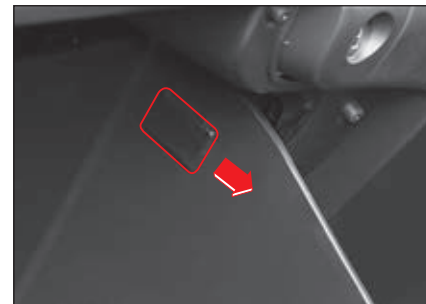

Caution

- Do not pull the fixing holder of the glove box forcibly. Doing so may cause the fixing holder to deform, and the fixing status of the glove box may be loose when it is installed again.

- 3 Separate the glove box damper clip from the bottom right side of the glove box.



- 4 Remove the A/C filter cover by pressing the right side of the A/C filter cover.



- 5 Remove the A/C filter.

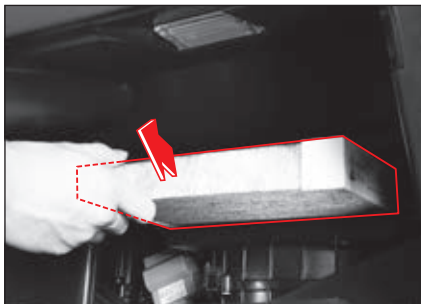

- 6 Replace it with a new one. Install it with the "AIR FLOW" arrow" facing down.

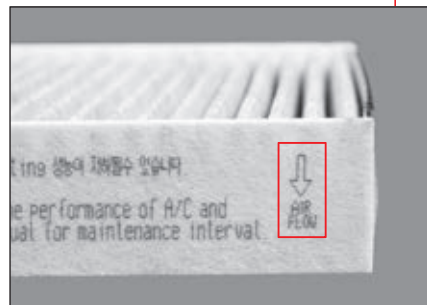
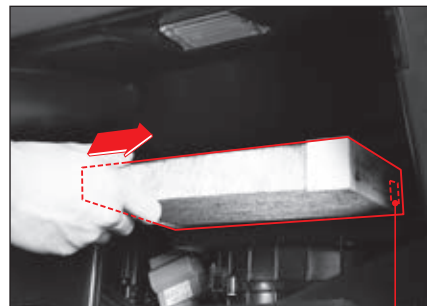

- 7 After replacing it, install it in the reverse order of A/C filter removal.

Checking the tires and wheels

Checking the tire pressure

Check the tire pressure before driving the vehicle or when the tires are cooled down completely.

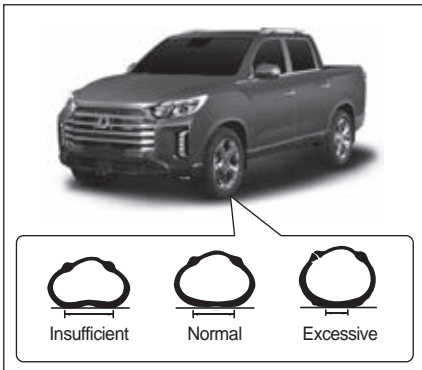

Caution

- If the tire pressure is higher or lower than the prescribed value, the riding comfort or steering stability are lowered and the tires are easily damaged and uneven tire wear occurs. Be sure to adjust the tire pressure to the prescribed value.

Prescribed tire inflation pressure

Tire size Rim size	Max load	Recommended cold tire inflation pressure -kPa (psi)			
		Normal load		Maximum load	
		Front	Rear	Front	Rear
235/70R17XL 111H 7.0x17 (LEAF SPRING)	1,090 kg	234 (34)	234 (34)	234 (34)	310 (45)
235/70R17 107H 7.0x17 (5-LINK)	975 kg	234 (34)	234 (34)	234 (34)	262 (38)
255/60R18 108H 7.5Jx18 (5-LINK)	1,000 kg	234 (34)	234 (34)	234 (34)	262 (38)
255/50R20 105H 8.0Jx20 (5-LINK)	975 kg	234 (34)	234 (34)	234 (34)	262 (38)

Notice

- The prescribed tire inflation pressure is measured when the tire has been cooled down properly at room temperature. If you need to drive the vehicle on an expressway for a long period of time, increase the tire inflation pressure by 4~5psi from the prescribed value on the table.

Wheel alignment status and the balance between tires and wheels

If the wheels are not aligned as prescribed, it leads to uneven or accelerated wear of the tires and causes the vehicle to lead to one side while driving.

If the tires and wheels are not balanced, it may lead to vehicle vibration or uneven wear of tires.

In such case, have your vehicle checked and maintained at a KG Mobility authorized service center.

Tire sizing chart

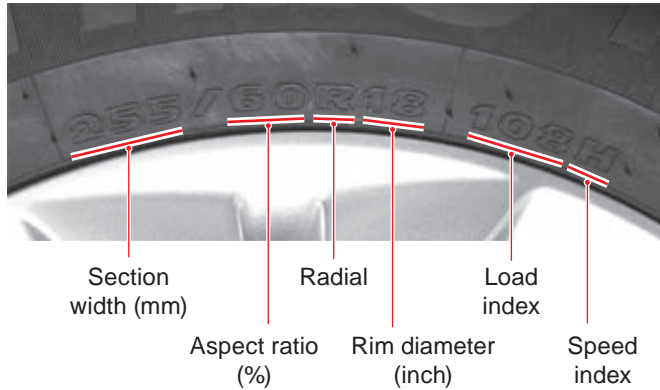

Load index		Speed index	
Symbol	Maximum Load (kg)	Symbol	Maximum speed (Km/h)
102	850	S	180
104	900	T	190
106	950	U	200
108	1,000	H	210
110	1,060	V	240
112	1,120	Z	Over 240



Tire Date of Manufacture

In general, all tires should be replaced after six years from the date of manufacture regardless of the remaining tread.

You can check the date of manufacture by looking for the DOT Tire Identification Number (TIN). The last 4 digits of TIN indicates the date of manufacture with the front 2 digits representing the week and the last 2 digits representing the year in which the tire was manufactured.

Temperature Inside the Tire



The temperature inside the tire increases during driving.

Overloaded vehicle, low tire pressure or driving at a high speed creates more heat and the heat builds in the tire. The limit temperature of tires is about 125°C. If the temperature exceeds this limit, the adhesion between the underlying layers of tire is significantly reduced, and this may result in an accident.

Always maintain correct tire inflation pressure specified by the manufacturer and take a break every 2 or 3 hours of highway driving.

The temperature inside the tire drops about 20°C for 10 minutes of vehicle stationary.

Checking the status of tire wear

Check the status of tire wear on the contact surface of the tire along the marked part. Replace the tire before the tire tread goes down below the wear limit.

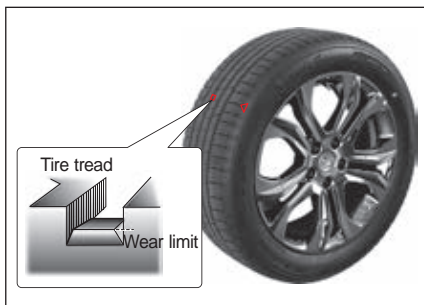

Warning

- Check the tire for damage or the status of tire wear frequently and replace if necessary.
- If the tire is worn excessively, the braking distance may increase or the steering wheel may become heavier. Also, the tire may be blown, resulting in an accident.

Rotating the tire positions

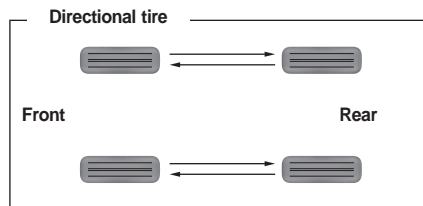
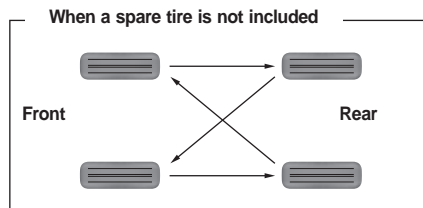

☞ Refer to "When you have rotated the tires" (p.2-30)

Warning

- Be sure to replace a tire at a KG Mobility authorized service center or a professional tire shop.
- Be sure to install the same manufacturer's tires with the same specifications, not mixing different types of tires.

Snow tire

Use snow tires in order to drive the vehicle safely on a snowy road or an icy road during winter.

The snow tires should be installed on all 4 wheels.

Warning

- If the snow tires for driving on a snowy road and an icy road are not installed, drive the vehicle as slowly as possible.
- The snow tire with the driving direction arrow on its side wall should be installed according to the driving direction.
- The snow tire is manufactured in consideration of the characteristics of road surface during winter. However, it is an auxiliary aid, so be sure to install the snow chains on a snowy road and an icy road and drive the vehicle as slowly as possible for safe driving.
- Replace the snow tires with ordinary tires when the winter has passed. Store the snow tires in a cool place with no direct sunlight and be careful not to allow them to come into contact with oil, grease or fuel.

Tire chain

- Install the tire chains on the rear wheels for a 2-wheel drive vehicle and install the tire chains on both the front and rear wheels for a 4-wheel drive vehicle. If it is impossible, be sure to install the tire chains on the rear wheels.
- In case of a vehicle equipped with aluminum wheels, the wheels may be damaged if the tire chains are used. Therefore, use snow tires instead of the tire chains. If it is impossible, use the wire-type tire chains.
- When the tire chains are installed, drive the vehicle at a prescribed speed recommended by the chain manufacturer or at a speed of 30 km/h or less.
- If you hear a sound of the tire chain hitting the vehicle body, stop the vehicle immediately, check the installation status of the tire chains and tighten the tire chains if necessary.
- Take the tire chains off immediately on a normal road to prevent the chains from being damaged.
- Do not use the tire chains on a normal road, use only on a snowy road or an icy road.



Warning

- **After driving the vehicle with the tire chains installed for a certain distance (0.5~1 km), check the installation status of the tire chains and for any damage to the vehicle body. If the tire chains are loose, tighten them again.**
- **Be sure to use a tire chain that meets the specifications and install it correctly. If the tire chain does not meet the specifications or is installed incorrectly, the vehicle may be damaged or a serious problem in the steerability and safety of the vehicle may occur.**

Cautions for checking the tires and wheels



Caution

- **Be sure to use the same manufacturer's tire with the same specifications for all tires in order to maintain the characteristic of the vehicle safely.**
- **Be sure to check the status of tire wear and the tire pressure before driving the vehicle.**
- **The tire pressure and tightening status of tire wheel nuts should be checked frequently. Be sure to check the vehicle condition, tire pressure and the tightening status of tire wheel nuts before driving the vehicle for a long distance.**
- **Only use the same manufacturer's tires that meet the specifications. If the tire that does not meet the specifications when installed, you cannot operate the steering wheel normally, the fuel consumption may increase and the driving system or braking system of the vehicle may become abnormal. In addition, the vibration of the steering wheel and uneven tire wear may occur when you drive the vehicle at a high speed.**
- **Installing a tire that does not meet the specifications or a retreaded tire voids the warranty repair.**



Caution

- Check the tires and wheels always before driving the vehicle. If the wheels are damaged, the tire pressure may decrease and the tires may be damaged.
- If a tire has been impacted by a stone or any other objects while driving, have your vehicle checked and serviced at a KG Mobility authorized service center immediately.
- Do not mix the tires and wheels installed when the vehicle was shipped with other tires and wheels. Doing so may affect the driving stability of the vehicle, causing an accident.
- Check the status of the emergency tire service kit. Always check the operation status of the compressor and the preparation of sealant.
- Be sure to check and add the tire pressure before driving the vehicle for a long period of time or at a high speed. Driving the vehicle at a high speed with low tire pressure may cause the tires to burst due to the standing wave effect, resulting in a risk such as a rollover.

Vehicle management during winter

Various unfit elements for driving occur on a road in winter, so make sure to prepare in advance in order to respond properly.

Starting the engine and driving the vehicle

During winter, the resistance of the power train in the engine increases and the performance of the battery and the starting motor is lowered so that the engine may not be started smoothly. Start the engine in a proper way.

After starting the engine, allow enough time to warm it up before driving the vehicle. It will increase the engine's life expectancy and ensure smooth driving.



Caution

- Replace the engine oil and the fuel filter according to their replacement intervals. A decrease in flowability and the clogging of the fuel filter and the oil filter due to the contamination of engine oil may become an obstacle to starting the engine in winter.
- Do not add additives such as white kerosene or alcohol besides the genuine fuel arbitrarily in order to improve the startability. Doing so may damage the engine and relevant parts or cause excessive exhaust gas emission due to inadequate lubrication of important parts inside of the fuel system and different characteristics such as flash point.
- Be sure to preheat a diesel-powered vehicle before starting the engine.

Managing the engine oil

This vehicle is shipped after it is filled with 4-season engine oil. If the replacement interval has not come, you do not need to change the engine oil.

Managing the engine coolant

Be sure to check the concentration of coolant before the temperature begins to drop.

If only water has been added to the vehicle without antifreeze when replenishing the coolant, the coolant may freeze, damaging the engine and the cooling system seriously when the temperature drops below 0°C.



Caution

- When adding or replacing the coolant, be sure to use a mixture of water and antifreeze at the ratio of 50:50.
- Use only the KG Mobility genuine antifreeze for the coolant.

Notice

- This vehicle is shipped after it is filled with 4-season antifreeze.
- The antifreeze mixture ratio at the time of vehicle delivery is 45%.

Managing washer fluid

Use only genuine washer fluid that does not freeze in cold weather.

If the washer fluid freezes due to the use of a non-standard washer fluid it may damage the washer motor and interfere with safe driving.

Installing a snow tire

It is recommended to replace the tires with snow tires during winter in order to prevent the vehicle from slipping on a snowy road or an icy road.



Caution

- Drive the vehicle at a lower speed than usual if the snow tires are installed.
- Install the tire chains in a correct way. Failure to do so may damage the wheel house or the vehicle body.

Managing the A/C

If the A/C is not used for a long period of time, the lubrication inside the A/C is not carried out. As a result, the packing inside of the A/C may be hardened that may lead to refrigerant leak and malfunction due to rusting.

It is recommended to operate the A/C for 5 to 10 minutes once a week regardless of season in order to maintain the performance of the A/C continuously.



Caution

- **Do not remove the refrigerant in winter even if the A/C is not used.**

Management of a diesel-powered vehicle

In severe cold, paraffin which is one of the chemicals in diesel fuel, may be separated from the diesel fuel, lowering the starting performance of the vehicle. A flow improver is added to the diesel fuel (for winter) sold in the country during winter.

However, the components of the flow improver for the fuel supplied may vary according to the average temperature during winter by region.

Park your vehicle indoors if possible during winter to ensure smooth starting and fill the fuel tank after driving to prevent the fuel system from freezing due to water vapor condensation.

Other maintenance

- Prepare sand bags, snow chains, shovel, gloves and old clothes in the vehicle in advance in preparation for driving the vehicle in the countryside or heavy snow.
- Do not drive too fast, accelerate or brake or steer the vehicle suddenly on a snowy road or an icy road.
- When you drive the vehicle on a snowy road or an icy road, keep a safe distance twice as long as usual from a preceding vehicle and downshift to use the engine brake effect properly when you stop the vehicle.
- Do not operate the wiper when it is frozen. Doing so may overload, damaging the wiper motor.
- When you drive the vehicle on a snow-covered road, a large amount of snow may build up under the wheel house, making it difficult for you to operate the steering wheel, so check and remove it frequently.
- When you have passed a road where calcium chloride is sprayed, wash your vehicle as soon as possible to prevent the bottom part of the vehicle from being corroded.

- If you park the vehicle in a snowy place, the brake system may freeze, reducing the braking force while driving. In such case, depress the brake pedal frequently while driving the vehicle at a low speed, restoring the braking force, and then drive the vehicle normally.
- Do not start off in the vehicle forcibly while the parking brake is frozen. Doing so may damage the vehicle. Be sure to start off in the vehicle after the parking brake has melted.

Cautions for parking during winter

- When the temperature falls down below zero, the parking brake may not be released due to the freezing of EPB-related devices.
- When you park the vehicle on a flat and safe place in weather with below zero temperatures, use a chock on the wheels after parking instead of using the EPB.
- If the vehicle is parked/stopped while idling for a long time after starting the engine in cold weather, the water vapor in the exhaust gas condenses and accumulates inside the exhaust pipe. The accumulation of water inside the exhaust pipe can cause noise. However, it is discharged during medium- and high-speed driving.
- When you park the vehicle in weather with below zero temperatures, moisture remaining in the exhaust pipe might have frozen. This is a normal state of the vehicle. Do not depress the accelerator pedal or idle the engine for a long period of time in order to remove frozen moisture.

Cautions for using biodiesel fuel



Caution

The fuel system of the CRDI (Common Rail Direct Injection) type engine is very precisely machined, so using a low quality fuel or an excessive amount of biodiesel fuel may damage the engine due to water, impurities or floating particles included in the fuel.

- Using fuel mixed with an excessive amount of biodiesel fuel may cause the clogging of the fuel filter, power loss, engine idling problems, engine stall and difficulty in starting the engine during winter due to the generation of floating particles according to the characteristics of the biodiesel and damage the engine and the fuel system.
- Currently, the KG Mobility vehicle is designed in the way that only the product whose mixing ratio between biodiesel and normal diesel falls within a legally acceptable value can be used for safe driving.
- Using biodiesel whose mixing ratio is beyond such a legally acceptable value or using diesel sold in the market after adding biodiesel may lead to a malfunction in the vehicle and such a malfunction is not covered by the warranty.

What is biodiesel?

Biodiesel is a fuel made by reacting vegetable oil extracted from beans, rapeseed and rice bran with alcohol. Its physical and chemical properties are similar with those of normal diesel, so it is considered as an alternative (renewable) energy to the fuel of a diesel engine.

Cautions for driving a vehicle equipped with the turbo charger



Caution

When the supply of oil is suspended while the bearing unit in the turbo charger is spinning at a high speed, the turbo charger may seize. Therefore, handle the vehicle as follows.

- Replace the engine oil according to the replacement interval. If the engine oil is not changed according to the prescribed replacement interval, the bearing unit of the turbo charger may not be lubricated smoothly, causing the bearing unit to be seized or damaged.
- Right after starting the engine, do not start off or accelerate suddenly or increase the engine RPM rapidly during idling. Doing so may cause oil not to be supplied to the bearing unit of the turbo charger, damaging the bearing unit of the turbo charger.
- After driving the vehicle at a high speed or on a hillside road, do not turn off the engine immediately. Idle the engine for approximately 1 minute and then turn off the engine. Turning off the engine immediately while the turbo charger is spinning at a high speed, engine oil may not be supplied to the turbo charger, damaging the bearing part of the turbo charger.
- After changing the engine oil or replacing the oil filter, do not start off in the vehicle immediately. Start off in the vehicle after idling the engine for approximately 2 minutes or more.

What is the turbo charger?

The turbo charger rotates the turbine with the force of exhaust gas, compresses air with such rotatory force and supplies the compressed air to the combustion chamber of the engine to raise the engine output.

At this time, when the intercooler is installed between the turbo charger and the intake vent of the engine to cool down air, the air density increases in this process, improving the output of the engine further.

Warnings for self-maintenance

When the vehicle is checked and serviced by the driver, proper knowledge and special attention are necessary for preventing injury and damage to the vehicle.



Warning

- After driving the vehicle, the systems including the engine, radiator, exhaust manifold, catalyst converter and exhaust pipe (muffler) are very hot, so caution should be taken when checking the engine room. Turn off and cool down the engine properly before checking in order to prevent a burn.
- Be sure to turn off the engine, place the gear shift lever in the P (parking) position and apply the parking brake when checking the vehicle.
- Be sure to turn off the engine when checking the vehicle in a garage or a poorly ventilated space.
- Do not smoke when checking the battery, fuel-related parts or the washer fluid. Do not check the battery, fuel-related parts or the washer fluid in a place where flames or sparks occur easily.
- Do not connect or disconnect the battery when the START/STOP switch is in the ON position.
- When you connect battery cables, be careful not to switch the positive and negative cables.
- The battery cables and the wires in the vehicle transfer high current and voltage. Be careful of a short circuit.
- Keep the used oils, coolant and other fluids out of children's reach.
(Ask a professional company for disposal.)

- The cooling fan may spin even if the engine is not running. Separate the negative battery cable when you check the vehicle near the cooling fan or the radiator.
- Check the level of various oils and coolant daily. Driving the vehicle with insufficient oils or coolant may damage the vehicle which is not subject to warranty repair.
- Be sure to use genuine parts for replacing consumable parts.
- When you add any oil or coolant, be careful for the oil or coolant not to come into contact with your body, clothes or the painted surface of the vehicle. If it comes into contact with your body, wash it off immediately and consult your doctor.
- Adding more oil or coolant than the prescribed level may damage the systems. Always add a proper amount of oil or coolant.
- When you inject or add any oil or fluid, do not allow foreign materials such as moisture or dust to enter. Failure to do so may lower the vehicle performance and make normal functions inoperable, causing an accident while driving.
- When a long period of time has passed even if the mileage is low, the level of oils or coolant may become low. Check it frequently and add it if necessary.
- Used oils, coolant and other solutions and containers should not be discarded with household waste. Discard oils, coolant and other solutions according to a legitimate disposal procedure.

Regulation of exhaust gas and relevant systems

Particulate reduction management for diesel-powered vehicle

The generation of particulates is closely related to the status of the air cleaner, fuel filter and fuel, injector and engine adjustment status, load amount and the number of occupants.

For a diesel-powered vehicle, the amount of particulates can be reduced in any of the following methods.

- **Do not idle the engine for a long period of time.**

When the engine is idling, the exhaust gas emission speed is slow, causing difficulty in the emission of particulates (carbon waste), so particulates may build up in the exhaust pipe (muffler). In particular, if you idle the engine for a long period of time while using the A/C and electrical systems, the accumulation amount of particulates may increase.

- **Replace the consumable parts according to the replacement intervals and clean the vehicle frequently.**

Since the fuel filter, air cleaner and engine oil affect the exhaust gas, output and fuel economy of the vehicle significantly, these parts should be replaced and cleaned periodically.

In particular, if the air cleaner is clogged, a large amount of particulates is generated. Clean and replace the air cleaner parts frequently if necessary.

If the vehicle is driven under severe conditions such as an unpaved road, clean and replace the air cleaner parts earlier than the interval according to the contamination status.

- **Do not remodel or modify your vehicle illegally.**

A vehicle whose intake/exhaust system of the engine and electronic control unit are modified illegally, emits an excessive amount of exhaust gas and particulates.

- **Do not overload.**

Overloading may damage the engine, increasing particulates and reducing the life of the engine.



Warning

- **Do not use a low quality fuel or inappropriate additives. Doing so may damage the fuel storage and supply system, engine and exhaust gas-related systems.**
- **Using additives or other inappropriate fuels voids the warranty repair.**
- **Use low sulfur diesel for a diesel-powered vehicle. When fuel with a sulfur content of over 0.5% of the total fuel is used, an excessive amount of exhaust gas may be generated and the oil flow function on the specially treated inside wall of the cylinder may be obstructed.**

Emission reduction device

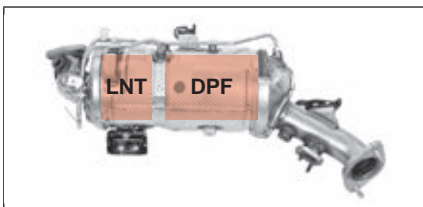
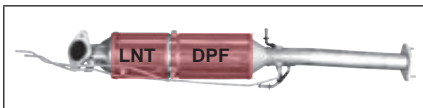
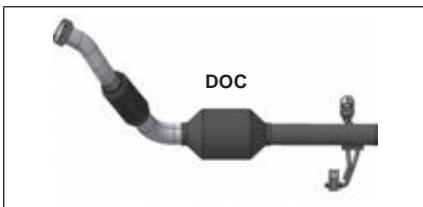

This vehicle is equipped with the Diesel Oxidation Catalyst (DOC) and Diesel Particulate Filter (DPF) for emission reduction devices.

The DOC converts HC and CO₂ in the fuel to H₂O and removes 80% of the Soluble Organic Fraction (SOF) among particulate materials, thereby reducing 25% or more of particulate materials.

The DPF collects particulate materials to the filter and removes them by combustion. This device removes 95% or more of particulate materials.

Diesel Oxidation Catalyst (DOC) - EU4

The Diesel Oxidation Catalyst (DOC) which are exhaust gas aftertreatment devices.

LNT (Lean & NOx Trap) DPF (Diesel Particulate Filter) - EU6

The LNT (Lean & NOx Trap) DPF (Diesel Particulate Filter) is a system to eliminate the nitrogen oxide from exhaust emissions. Use the specified fuel to avoid exhaust smell due to the poor quality fuel and to maintain the normal performance of the LNT DPF.

Regeneration Process

“Regeneration” is the process of combusting particulates when a certain amount of particulates is collected in the filter. In this process, the temperature of exhaust gas rises to approx. 600°C by fuel control and particulates are effectively incinerated.

When the Engine CHECK Indicator Flashes

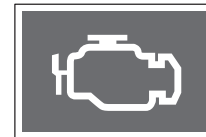

Regeneration may not be performed due to several operating conditions. And in this case, the engine CHECK indicator flashes. This flashing function is to inform the driver to take action for the proper regeneration of the filter.

If the engine CHECK indicator flashes, drive the vehicle at over 80 km/h for 20 minutes to regenerate the DPF. When the amount of particulates is lowered down to a certain limit, the engine CHECK indicator goes off.

Exhaust gas after-treatment system II (SCR)*



Our exhaust gas after-treatment system applies the SCR (Selective Catalytic Reduction) system to reduce nitrogen oxide (NOx) remaining in the exhaust gas.

This system consists of urea solution injection system, urea solution injection control system (DCU) and SCR catalyst.

Warning due to low urea solution level

Low urea solution level warning appears on the display of the instrument cluster separately in 3 levels according to the distance the vehicle can be driven with the remaining urea solution.

Caution

- Do not drive the vehicle without replenishing the urea solution when the low urea solution level warning appears or the warning lamp turns on. Doing so may damage the urea solution system significantly or make the vehicle inoperable. Add urea solution or have your vehicle checked and serviced at a KG Mobility authorized service center immediately.

Level 1 warning

Supervision type



Insufficient UREA solution.

Standard type



Insufficient UREA solution.

- The mileage the vehicle can be driven when this warning message appears is 2,400 km to 800 km.
- The relevant warning message appears for 15 seconds every 200 km or 4 hours.
- If this warning message appears, replenish 6 L of urea solution or more immediately.

Caution

- If you start the engine immediately after adding urea solution, the engine may not start temporarily. Wait until the urea solution level gauge rises and stops completely, and then start the engine.

Notice

- The amount of urea solution to be consumed may vary depending on driving habits and surrounding environment.
- Approximately 1.0 to 1.5L of urea solution is consumed when the vehicle is driven for 1,000 km.
- In the Level 1 warning, only the warning message appears. The warning lamp does not turn on.

Level 2 warning

Supervision type



Unable to restart engine after 000 km! Add UREA solution

Standard type

Unable to restart engine after 000 km! Add UREA solution

- The mileage the vehicle can be driven when this warning message appears is 800 km to 0 km.
- In the level 2 warning, the warning buzzer sounds once and the warning lamp stays on and the warning message is displayed continuously.
- If this warning message appears, replenish 10 L of urea solution or more immediately.

Level 3 warning

Supervision type







Unable to restart engine as UREA solution is depleted





Standard type



Unable to restart engine as UREA solution is depleted





- If this warning occurs while driving, driving is possible, but the engine cannot be restarted when it is turned off.
- In the level 3 warning, the warning buzzer sounds once and the warning lamp stays on and the warning message is displayed continuously.
- If this warning message appears, replenish sufficient amount of urea solution immediately.

Warning due to faulty urea solution system, low urea solution and catalyst efficiency

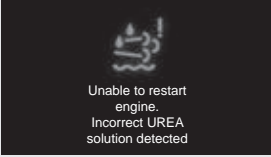
Item	Supervision type	Standard type	Activation conditions
Warning due to an electrical defect and defect in the urea solution injection control system	 Check UREA solution	 Check UREA solution	<ul style="list-style-type: none"> If an electrical defect and defect in the urea solution injection control system occurs, the 1st warning appears for 50 km.
	 Unable to restart engine after 000 km! Check UREA solution	Unable to restart engine after 000 km! Check UREA solution	<ul style="list-style-type: none"> After the 1st warning, the 2nd warning appears when the mileage the vehicle can be driven is 800 km to 0 km.
	 Unable to restart engine. Check UREA solution	Unable to restart engine. Check UREA solution	<ul style="list-style-type: none"> After the 2nd warning, the 3rd warning appears when the mileage the vehicle can be driven is 0 km. In such case, the engine cannot be started again.

Item	Supervision type	Standard type	Activation conditions
Warning due to a defect of the urea solution injection system	 Check UREA solution injection device	 Check UREA solution injection device	<ul style="list-style-type: none"> If a defect of the urea solution injection system occurs, the 1st warning appears for 50 km.
	 Unable to restart engine after 000 km! Check UREA solution injection device	Unable to restart engine after 000 km! Check UREA solution injection device	<ul style="list-style-type: none"> After the 1st warning, the 2nd warning appears when the mileage the vehicle can be driven is 800 km to 0 km.
	 Unable to restart engine. Check UREA solution injection device	Unable to restart engine. Check UREA solution injection device	<ul style="list-style-type: none"> After the 2nd warning, the 3rd warning appears when the mileage the vehicle can be driven is 0 km. In such case, the engine cannot be started again.

Item	Supervision type	Standard type	Activation conditions
Warning due to low quality urea solution	 <p>UREA solution is inappropriate</p>	 <p>UREA solution is inappropriate</p>	<ul style="list-style-type: none"> If low quality urea solution is used, the 1st warning appears for 50 km.
	 <p>Unable to restart engine after 000 km! Inject appropriate UREA solution</p>	<p>Unable to restart engine after 000 km! Inject appropriate UREA solution</p>	<ul style="list-style-type: none"> After the 1st warning, the 2nd warning appears when the mileage the vehicle can be driven is 800 km to 0 km.
	 <p>Unable to restart engine. Incorrect UREA solution detected</p>	<p>Unable to restart engine. Incorrect UREA solution detected</p>	<ul style="list-style-type: none"> After the 2nd warning, the 3rd warning appears when the mileage the vehicle can be driven is 0 km. In such case, the engine cannot be started again.

Item	Supervision type	Standard type	Activation conditions
Warning due to low SCR catalyst purification efficiency	 <p>SCR catalyst low efficiency</p>	 <p>SCR catalyst low efficiency</p>	<ul style="list-style-type: none"> If the SCR catalyst purification efficiency is low, the 1st warning appears for 50 km.
	 <p>Unable to restart engine after 000 km! Check SCR catalyst</p>	 <p>Unable to restart engine after 000 km! Check SCR catalyst</p>	<ul style="list-style-type: none"> After the 1st warning, the 2nd warning appears when the mileage the vehicle can be driven is 800 km to 0 km.
	 <p>Unable to restart engine. Check SCR catalyst</p>	<p>Unable to restart engine. Check SCR catalyst</p>	<ul style="list-style-type: none"> After the 2nd warning, the 3rd warning appears when the mileage the vehicle can be driven is 0 km. In such case, the engine cannot be started again.

Filling urea solution



- When the low urea solution level warning message appears, replenish sufficient amount of the urea solution immediately for safe driving regardless of the remaining urea level indicated on the gauge.
- Fill the urea solution at a gas station if possible.
If you fill the urea solution with the injector equipped with the urea shut-off valve at a gas station, there is no concern of the urea to overflow.
- If you have to purchase and fill urea solution by yourself, fill the proper amount of urea carefully not for the urea solution to overflow.

- 1 Place the gear shift lever in the P (parking) position.
- 2 Be sure to turn off the engine.
- 3 With all doors unlocked, open the fuel inlet cover (1).
- 4 Open the urea solution inlet cap (2) by turning it counterclockwise.
- 5 Fill the urea solution using the urea injector (gas station) or the urea bottle.
- 6 After filling the urea solution, close the urea solution inlet cap (2) by turning it clockwise until a clicking sound occurs.
- 7 Close the fuel inlet cover (1).



Caution

Cautions for filling urea solution

- When filling the urea solution, be careful for the urea solution to not overflow out of the inlet.
- If the urea solution comes into contact with your body when filling the urea solution, wash it off properly using clean water immediately. If the urea solution remains on the surface of the vehicle, the relevant part becomes white crystal, contaminating the surface.
- When filling the urea solution, be careful not to fill the urea solution into the fuel inlet. Doing so may affect the fuel system and other vehicle systems, damaging the vehicle significantly.
- Do not open the urea solution inlet cap in a sealed space or when the temperature of the vehicle or near the vehicle is high. Doing so may cause ammonia vapor to escape.
- Fill the urea solution in a shady and well-ventilated area. If the urea solution is exposed to direct sunlight, ammonia vapor may be generated. At this time, never inhale ammonia vapor.
- Only use genuine urea solution that meets the ISO 22241 standard. Using low quality urea solution may damage the vehicle system and make the vehicle inoperable.

Restriction of restarting due to low urea solution level

If urea solution is not added continuously after the level 2 warning due to low urea solution level occurs, restarting may become impossible along with the level 3 warning.

- In order to prevent the restriction of restarting in advance, replenish at least 10 L of the urea solution immediately when the level 2 warning due to low urea solution level occurs.



Caution

- If restarting is impossible due to the occurrence of the SCR warning for reasons other than low urea solution level, request a KG Mobility authorized service center for help immediately.
- In the event of SCR warnings except for the 1st warning due to low urea solution level, the warning buzzer sounds once and the warning lamp stays on and the warning message is displayed continuously.

How to disable restart protection

If the engine does not start due to a restart restriction, you can fix the problem as follows:

When the warning message "Urea depleted and engine restart not possible" is displayed, replenish the urea of at least 10L.

Replenish the urea and wait until the warning message disappears with the ignition switch turned on. Then, start the engine.



Caution

- If the engine does not start after the sufficient amount of urea has been replenished, have it inspected and serviced by KG Mobility Dealer or KG Mobility Authorized Service Center.

Storing urea solution

- Depending on the storage condition, the urea solution smells like ammonia a little bit when the bottle is opened.
- The expiration date of urea solution may vary according to the storage temperature. Be sure to check the expiration date specified by the urea solution supplier according to the storage temperature.
- Seal the urea solution bottle tightly and store it in a well-ventilated area.

Notice

- When you park the vehicle in a sealed space, the exhaust gas from the vehicle may smell like ammonia. This is a normal phenomenon that occurs when the urea solution is used in the SCR operation process.

Cautions for the exhaust gas after-treatment system (SCR)



Caution

Caution for personal injury

- Use the urea solution safely after fully familiarizing yourself with the contents of the relevant owner's manual.
- The urea solution is a non-flammable, non-toxic, colorless and odorless aqueous liquid, but it may contain a very small amount of heavy metals, so caution should be taken when you handle it.
- When you handle the urea solution, wear protective gloves, protective clothing and protective goggles.
- The urea solution may irritate your skin, eyes and respiratory system. If you have an allergic reaction, consult your doctor immediately.
- If the urea solution comes into contact with your body, wash it off properly using clean water immediately. If necessary, consult your doctor.
- If you drank the urea solution, wash your mouth with clean water immediately, drink plenty of water and consult your doctor.
- Never allow children to touch the urea solution.
- Never allow moisture coming out of the exhaust pipe to come into contact with your skin. Failure to do so may damage your skin due to slightly acidic moisture.
- The exhaust gas after-treatment system operates at very high temperature. Be sure to cool down the system properly before you carry out the service so as not to get burned.

Cautions for SCR and vehicle damage

- Do not apply an impact to the SCR. Doing so may damage the catalyst in the SCR.
- Do not change the exhaust pipe length, direction and structure of the exhaust system arbitrarily. Doing so may cause severe damage to the exhaust gas reduction efficiency or the system.
- Only use genuine urea solution that meets the ISO 22241 standard. Using low quality urea solution may damage the vehicle system and make the vehicle inoperable.
- Do not use low quality urea solution or urea containing an unauthorized additive. Doing so may contaminate the air environment and cause severe damage to the urea solution system and other vehicle systems.

Cautions for filling urea solution

- When filling the urea solution, be careful for the urea solution to not overflow out of the inlet.
- If the urea solution comes into contact with your body when filling the urea solution, wash it off properly using clean water immediately. If the urea solution remains on the surface of the vehicle, the relevant part becomes white crystal, contaminating the surface.
- When filling the urea solution, be careful not to fill the urea solution into the fuel inlet. Doing so may affect the fuel system and other vehicle systems, damaging the vehicle significantly.

- Do not open the urea solution inlet cap in a sealed space or when the temperature of the vehicle or near the vehicle is high. Doing so may cause ammonia vapor to escape.
- Fill the urea solution in a shady and well-ventilated area. If the urea solution is exposed to direct sunlight, ammonia vapor may be generated. At this time, never inhale ammonia vapor.

Notice

- The mileage the vehicle can be driven and actual level of the urea solution may vary depending on driving habits and road environment.
- The urea solution injection system collects the urea solution in the urea solution supply line into the urea solution tank for several minutes after the engine is turned off. Check or service the system after the urea solution is collected back completely.
- The urea solution may freeze at a low temperature (-11 °C), so it is impossible to measure the remaining level of the urea solution accurately. When the urea solution melts through the hot wire after several minutes have passed after the engine is started, check the level of the urea solution.
- When the urea solution melts through the hot wire, it may take from several minutes to several tens of minutes depending on the driving conditions and surrounding environment.

Index

You can conveniently find important functions or terms from the content of this owner's manual in alphabetical order.

2WD (2H) mode 4-121
 4D Driving ☞ Refer to No
 Drugged, Drunk, Distracted and
 Drowsy (4D) Driving 1-25
 4WD HIGH (4H) mode 4-121
 4WD HIGH (4H) mode indicator .. 4-42
 4WD LOW (4L) mode 4-122
 4WD LOW (4L) mode indicator.... 4-42
 4WD System 4-120
 What is the part time transfer
 case? 4-120
 What is tight cornering? 4-122
 4WD system check warning
 indicator 4-42, 4-122
 4WD system ☞ Refer to the
 4WD system 4-120

A

A/C
 Independent Temperature Control
 (SYNC Off) 3-55
 Temperature Synchronization
 Control (SYNC On) 3-56
 ACC status (START/STOP
 switch) 4-9
 Activating/deactivating the
 warning buzzer of rear and side
 warning system 4-169
 Additional functions of smart
 key* 4-19
 Adjusting the angle of the
 backrest 3-8, 3-10

Adjusting the angle of the head
 light 3-35
 Adjusting the headrest 3-6
 Adjusting the height/length of the
 steering wheel 3-66
 Adjusting the operation speed of
 the windshield wiper 3-46
 Adjusting the power seat 3-7
 AEBS ☞ Refer to Autonomous
 Emergency Braking System
 (AEBS) 4-160
 Air bag 2-18
 Collision detection sensor 2-19
 Air bag control module 2-19
 Air bag warning label 2-18
 Air bag warning lamp 2-18, 4-37
 Air conditioner 3-51
 Android auto 3-67
 Android device 3-67
 An infant or a small child must
 be seated in the rear seat with
 protective gear 1-26
 Antenna 3-70
 Anti-Lock Brake System (ABS) .. 4-150
 Anti-Lock Brake System (ABS)
 warning light 4-41, 4-151
 Anti-theft and warning system 2-32
 Around View Monitoring (AVM)
 system 4-200
 Front camera 4-200
 Rear camera 4-200

Auto cruise control indicator 4-49
 Auto cruise ENABLED 4-130
 Auto cruise READY 4-130
 Auto defogger system 3-59
 Auto door lock function at the
 time of driving 3-3
 Auto door unlock function at the
 time of collision 3-3
 Auto light 3-33, 3-40
 Autonomous Emergency Braking
 System (AEBS) 4-160
 Autonomous Emergency Braking
 System (AEBS) OFF indicator 4-45
 Autonomous Emergency Braking
 System (AEBS) warning light 4-44
 AUX port 3-68
 Average fuel economy (display of
 the instrument cluster) 4-52
 Average speed (display of the
 instrument cluster) 4-52
 AVM system ☞ Refer to the
 Around View Monitoring (AVM)
 system 4-200
 AV/Navigation 3-68
 AV screen (display of the
 instrument cluster) 4-55

B

Be Careful not to Have a Part of
 Your Body Caught When Using
 the Power Window 1-27

Blind spot collision assist (BSA)
 system 4-171
 Blind spot detection (BSD) system
 RCTW System 4-172
 Blind Spot Detection (BSD)
 system 4-170
 Bluetooth 3-67
 Bluetooth hands-free 3-69
 Brake system 4-148
 ABS (Anti-Lock Brake System) 4-150
 Electronic Brake-Force Distribution
 (EBD) 4-151
 Foot brake 4-149
 What is the fade phenomenon? 4-149
 What is the vapor lock
 phenomenon? 4-149
 Brake system warning light 4-41
 Breaking in a New Vehicle
 Correctly 1-34
 BSD system ☞ Refer to the
 Blind Spot Detection (BSD)
 system 4-170

C

Capacity/standard of brake fluid,
 oil and urea solution and engine
 coolant 6-5
 Capacity/standard of engine
 coolant, oil and urea solution and
 brake fluid 6-5
 Capacity/standard of oil and urea
 solution, engine coolant and

brake fluid.....	6-5	Cautions for Using the Vehicle		Child restraint for an infant or a		Protection Function (Delayed	
Capacity/standard of urea		Key (Smart Key).....	1-38	small child.....	2-10	Accelerator Pedal Response)	1-33
solution and oil, engine coolant		Cautions for Vehicle Ventilation ...	1-32	ISOFIX child restraint.....	2-13	Digital speedometer (display of	
and brake fluid.....	6-5	Cautions for Window Tinting	1-37	Child restraint ☞ Refer to 'Child		the instrument cluster).....	4-54
Card holder.....	3-74	Center room lamp	3-44	restraint for an infant or a small		Display of the gear shift point in	
Care and Cleaning of the		Certification Label.....	1-9	child'	2-10	M (manual) mode (display of the	
Interior	1-37	Change of specifications		Child safety door lock.....	3-4	instrument cluster).....	4-35
Car play	3-67	(options) and functions according		Cleaning and Maintaining Glass ..	1-37	Distance to empty (display of the	
Cases where the air bag does		to a change of design	4	Collision detection sensor	2-19	instrument cluster).....	4-51
not inflate.....	2-21	Charge warning light	4-38	Coming home light	3-40	Do Not Drive with the Doors or	
Cautions for Attaching		Check for Any Vehicles or Person		Console	3-77	Tailgate Open	1-27
Accessories	1-32	Passing by When Getting Out	1-28	Crossing an Intersection or		Do Not Drive With the Tailgate or	
Cautions for driving a vehicle		Checking and replacing fuses		Railroad Crossing.....	1-31	Doors Open	1-27
equipped with the turbo charger ..	6-59	and relays.....	6-36	Crossing a Railroad Crossing or		Do Not Hold a Part of Your Body	
Cautions for parking during		Checking and replacing the brake		Intersection	1-31	Out of the Sunroof or Window	1-27
winter	6-57	discs	4-150	Cruise Control Ready / Enabled		Do Not Hold a Part of Your Body	
Cautions for parking the vehicle		Checking and replacing the brake		Display.....	4-130	Out of the Window or Sunroof	1-27
on a downhill road.....	4-159	pads.....	4-150	Cruise control system.....	4-129	Do Not Load Hazardous	
Cautions for parking the vehicle		Checking and replacing the		Cruise control system indicator..	4-136	Materials.....	1-32
on a uphill road	4-158	lamps	6-38	Auto cruise control indicator	4-49	Do not Stop the Engine While	
Cautions for Polishing the		Replacing exterior lamps.....	6-43	Cup holder.....	3-76	Driving	1-29
Vehicle	1-36	Replacing the interior lamps.....	6-46			Do not use vehicle components	
Cautions for Polishing the		Checking Before Driving	1-20			for other purposes.....	4
Vehicle ☞ Refer to 'Cautions for		Checking the engine room	6-17	D		Do Not Warm Up the Engine or	
Polishing the Vehicle'	1-36	Checking the status of tire wear ..	6-52	Daytime Running Light (DRL).....	3-36	Check the Vehicle in a Sealed	
Cautions for the Depletion		Checking the tire pressure.....	6-50	D (driving) position	4-112	Space	1-31
of Battery when Connecting		Checking the tires and wheels.....	6-50	Deactivating the cruise control		Door.....	3-2
Uninterruptible Power Supply to		Checking the wheels ☞ Refer to		system	4-133	Auto door lock function at the time	
the Black Box System.....	1-34	'Checking the tires and wheels' ...	6-50	Defrosting and defogging.....	3-63	of driving	3-3
Cautions for the Protection of the		Checking the wipers and		Delayed Accelerator Pedal		Auto door unlock function at the	
Environment	1-5	replacing the blade.....	6-35	Response ☞ Refer to System		time of collision	3-3
Cautions for using biodiesel fuel..	6-58					Child safety door lock	3-4

Door courtesy lamp.....	3-44	Driving on a Hillside Road and Downhill Road.....	1-30	Eco Mode	3-60	Engine check indicator.....	4-42
Door handle switch.....	4-20, 4-23	Driving on a Muddy or Sandy Road.....	1-30	Electric power steering warning light.....	4-40	Engine Check Indicator	1-38, 1-40, 1-41, 1-42
Door LOCK/UNLOCK With Emergency Key	4-25	Driving on an Icy and Snowy Road.....	1-29	Electronic Brake-Force Distribution (EBD).....	4-151	Engine compartment fuse and relay box.....	6-36
Door map pocket.....	3-78	Driving on a River or a Road with a Pool of Water	1-30	Electronic Brake-Force Distribution (EBD) warning light	4-41, 4-152	Engine hood	3-28
Door open lever.....	3-2	Driving on a Road with a Pool of Water or a River.....	1-30	Electronic stability control system (ESP).....	4-153	Engine hood open lever.....	3-28
Door Outside Handle Switch Unlock (Safety UNLOCK disabled).....	4-24	Driving on a Sandy or Muddy Road.....	1-30	Electronic stability control system (ESP) OFF indicator.....	4-43	Engine hood open warning light.....	4-38
Drive mode (with EPS).....	4-125	Driving on a Snowy or Icy Road..	1-29	Electronic stability control system (ESP) ON indicator/warning light.....	4-43	Engine Number	1-9
Driver attention alert.....	4-55	Driving on Mountains and Unpaved Roads.....	1-29	Emergency measures in the event of emergency.....	5-1	Engine oil pressure warning light.....	4-37
Driver seat window safety function.....	3-18	Driving on the Expressway	1-31	In the event of a fire.....	5-38	Engine overheat warning lamp	4-39
Driving assist.....	4-55	Driving on Unpaved and Mountain Roads	1-29	In the event of a heavy snow.....	5-40	Engine RPM (display of the instrument cluster).....	4-33
Driving a vehicle equipped with an automatic transmission	4-116	Driving Position	1-23	In the event of an accident.....	5-37	Engine Warm-up	1-28
Safety mode of the automatic transmission.....	4-118	Driving speed (display of the instrument cluster).....	4-33	When a tire is flat	5-9	ESP  Refer to 'Electronic stability control system (ESP)' ...	4-153
What is automatic shift point?.....	4-117	Driving time (display of the instrument cluster).....	4-52	When the engine check indicator turns on.....	5-8	ESS  Refer to Emergency Stop Signal (ESS).....	4-152
What is the creep phenomenon?....	4-117	DRL  Refer to 'Daytime Running Light (DRL)'	3-36	When the engine is overheated so that the warning light turns on.....	5-6	Exhaust gas after-treatment system (LNT+DPF)	6-62
What is the engine brake?	4-117			When the engine has stopped due to a failure	5-36	Exhaust gas after-treatment system (SCR).....	6-63
What is the kick down function?	4-118			When the water separator warning light turns on (diesel-powered vehicle).....	5-8	Extinguisher.....	1-33, 5-38
Driving information after departure (display of the instrument cluster).....	4-53			When you need to have your vehicle towed.....	5-28		
Driving information display window.....	4-33						
Driving mode	4-125						
Driving on a Downhill Road and Hillside Road	1-30						

E		F	
EBD  Refer to Electronic Brake-Force Distribution (EBD)..	4-151	Fastening the seat belt by a pregnant woman.....	2-8
ECM room mirror.....	3-49	Filling urea solution	6-68
ECO indicator.....	4-48		

Foot brake	4-149
Front auto washer	3-46
Front camera	4-200
Front Camera Module (FCM).....	4-177
Front fog light	3-33
Front obstacle detection sensor.....	4-194
Front obstacle detection warning ON/OFF switch.....	4-194
Front/rear obstacle detection system	4-194
Front obstacle detection sensor.....	4-194
Rear obstacle detection sensor	4-194
Front room lamp (overhead console).....	3-43
Front seat	3-6
Front seat side grip handle	3-75
Front storage	3-76
Front windshield and washer fluid linkage	3-46
Fuel gauge (display of the instrument cluster).....	4-34
Fuel inlet.....	3-29

G

Gear selector lever in automatic transmission	
D (driving) position	4-112
M (manual) position	4-113
N (neutral) position.....	4-111
P (parking) position	4-111

If the gear shift lever cannot be moved from the P (parking) position to another position.....	4-115
R (reverse) position.....	4-111
Gear shift lever ☞ Refer to automatic gear shift lever	4-107, 4-110
Glass heater.....	3-58, 3-64
Global warning light.....	4-44
Glove box	3-77
Glove box lamp	3-45
Grip handle/coat hanger.....	3-75

H

Hazard warning lamp	3-34, 4-47
HBA ☞ Refer to 'High Beam Assist (HBA)'	3-37
HDC ☞ Refer to Hill Descent Control (HDC).....	4-155
Head light	3-33
Headlight ☞ Refer to 'Headlight'	3-33
Heater.....	3-51
Independent Temperature Control (SYNC Off).....	3-55
Temperature Synchronization Control (SYNC On).....	3-56
Heater and A/C controller.....	3-54
Heater and A/C controller (manual)	3-61
Heating and ventilation ☞ Refer to 'Seat ventilation and heating'... ..	3-13

HID (high intensity discharge) head lamp.....	6-42
High beam	3-34
High Beam Assist (HBA)	3-33, 3-37
High beam indicator	4-47
Hill Descent Control (HDC).....	4-155
Hill Descent Control (HDC) ON indicator/warning light.....	4-45, 4-156
Horn	3-66
Horn ☞ Refer to 'Horn'	3-66
How to Dehumidify Window Glass	3-58

I

If the gear shift lever cannot be moved from the P (parking) position to another position	4-115
Illumination ON indicator	4-46
Immobilizer system.....	2-32
Immobilizer system warning light	4-47
Importance of a periodic check.....	4
Independent Temperature Control (SYNC Off)	3-55
Inflating a tire.....	5-15, 5-22
Information Regarding the Installation of Accident Recording Devices and Provision of Information.....	1-2
Infotainment system	3-67
Installing a snow tire	6-55
Installing the towing hook.....	5-29
Instantaneous fuel economy (display of the instrument cluster).....	4-52
Instrument cluster.....	4-29
Standard type	4-29
Supervision type.....	4-31
Trip computer information.....	4-51
Instrument cluster warning lights and indicators	4-37
Intelligent / Adaptive Cruise Control.....	4-135
Interior fuse box	6-36
Interior temperature sensor.....	3-51
In the event of a fire.....	5-38
In the event of a heavy snow.....	5-40
In the event of an accident	5-37
iPad	3-67, 3-68
iPad ☞ Refer to 'iPad'	3-67
iPhone	3-67, 3-68
iPhone ☞ Refer to 'iPhone'	3-67
iPod	3-67, 3-68
iPod ☞ Refer to 'iPod'	3-67
ISG cumulative time	4-53
ISG (Idle Stop & Go) System.....	4-126
ISG indicator/warning lamp	4-49
ISG OFF indicator	4-49
ISOFIX child restraint.....	2-13

K

- Klaxon ☞ Refer to 'Horn' 3-66
- Korea Consumer Agency -
Precautions for Potentially
Hazardous Seat Belt related
Goods 1-3
- Korea Consumer Agency -
Precautions for the reduction of
non-crash incidents 1-4, 1-6

L

- Lane Change Assist (LCA)
system 4-171
- Lane Keeping Assistance System
(LKAS) 4-183
- LCA system ☞ Refer to the
'Lane Change Assist (LCA)
system' 4-171
- LDWS indicator/warning light 4-45
- LDWS (Lane Departure Warning
System) 4-177
- LDWS ☞ Refer to LDWS (Lane
Departure Warning System) 4-177
- Leaving-Home Light Control 3-40
- Lights and lamps 3-31
 - Turning off all lights 3-33
- Light switch 3-33
- Living home light 3-40
- Loading goods 3-24
 - Tailgate opening/closing 3-24

- Load limiter 2-7
- Long-term parking mode 1-34
- Low fuel level warning light 4-43

M

- Main menu on the instrument
cluster 4-50
- Management of diesel-powered
vehicle (during winter) 6-56
- Managing the A/C (winter) 6-56
- Managing the engine coolant
(winter) 6-55
- Managing the engine oil
(winter) 6-55
- Managing washer fluid (winter) 6-55
- Master symbol (Supervision
type) 4-49
- MAX A/C switch 3-63
- Message/pop-up message on the
display of the instrument cluster .. 4-62
- Mileage (display of the
instrument cluster) 4-52
- Mirror 3-48
 - ECM room mirror 3-49
 - Outside rearview mirror control
button 3-48
- Mirror and lamp 3-74
- M (manual) position 4-113
- Mood lamp 3-45

N

- Navigation ☞ Refer to 'AV/
Navigation' 3-68
- N (neutral) position 4-111
- No Drugged, Drunk, Distracted
and Drowsy (4D) Driving 1-25
- Non-crash incident ☞ Refer
to Korea Consumer Agency -
Precautions for the reduction of
non-crash incidents 1-4, 1-6
- No Sleeping in a Sealed
Vehicle 1-26
- No Sudden Maneuvering of the
Steering Wheel 1-31
- No Sudden Starting, Acceleration,
or Braking 1-29



O

- OFF status (START/STOP
switch) 4-9
- ON status (START/STOP
switch) 4-9
- Opening/closing sun shade
blind 3-21
- Operating smart audio and AV/
navigation using the steering
wheel 3-69
- Outside rearview mirror auto
folding/unfolding function 3-48
- Outside rearview mirror control
button 3-48

- OVM ☞ Refer to 'OVM tools' 5-2
- OVM tools 5-2

P

- Panic Button 4-18
- Parking
 - Cautions for parking during winter... 6-57
 - Safe Parking and Stopping 1-28
 - When parking the vehicle on a
downhill road 4-159
 - When parking the vehicle on a
uphill road 4-158
- Parking assist system 4-192, 4-194
 - Front/rear obstacle detection
system 4-194
 - Rear camera system 4-199
- Passing light ☞ Refer to
'Turning on the high beam and
low beam at the same time
(passing light)' 3-34
- Position of the gear shift lever
(display of the instrument
cluster) 4-35
- Potentially hazardous seat
belt related goods ☞ Refer to
the Korea Consumer Agency
- Precautions for Potentially
Hazardous Seat Belt related
Goods 1-3
- Power socket 3-71, 3-72
- Power window ☞ Refer to
'Window (power window)' 3-17

P (parking) position	4-111	Rear lamp.....	3-31, 6-40, 6-43	Restarting the engine when it cannot be started	4-10	Seat Belt	
Precautions for infants, children, old people, or pregnant women ...	1-26	Rear obstacle detection sensor.....	4-194	Restriction of restarting due to low urea solution level.....	6-69	Wearing the Seat Belt Correctly.....	1-24
Precautions for the Modification of the Vehicle and Structural Alteration	1-18	Rear seat.....	3-11	Resuming the cruise control system (RESUME)	4-134	Seat belt warning lamp	4-37
Prescribed tire inflation pressure.....	6-50	Rear seat heating switch Heating function (heater).....	3-15	Roof rack.....	3-79	Seat control switches, buttons, levers and straps.....	3-5
Pretensioner	2-7	Rear seat window lock function ...	3-19	Rotating the tire positions	6-52	Selective Catalytic Reduction (SCR).....	6-63
Purpose and application conditions of the instruction manual.....	3	Rear tray.....	3-75	R (reverse) position.....	4-111	Service kit for tire repair.....	5-10, 5-17
R		Removing moisture on the glass	3-65	S		Setting the cruise control system driving speed.....	4-131
Rain sensing wiper.....	3-47	Repairing a flat tire.....	5-11, 5-17	Safe Parking and Stopping	1-28	Setting the sensitivity of the forward collision warning for Autonomous Emergency Braking System (AEBS)	4-162
Rain sensor	3-47	Repairing a flat tire  Refer to 'Repairing a flat tire'	5-11, 5-17	Safety and Cautions for Driving... 1-25		SHB indicator	4-46
RCTA system  Refer to Rear Cross Traffic Alert (RCTA) system	4-172	Replacing A/C refrigerant/oil	3-52	Safety exit warning (SEW) system	4-175	Side grip handle on the rear seats.....	3-75
READY status (START/STOP switch)	4-9	Replacing exterior lamps.....	6-43	SCR  Refer to 'Exhaust gas after-treatment system (SCR)'	6-63	Slots for multimedia.....	3-68
Rear and side warning system	4-168	Replacing smart key battery	4-27	SCR warning lamp	4-39	Smart audio	3-67
Blind Spot Detection (BSD) system.....	4-170	Replacing the A/C filter	6-48	SD card (navigation)	3-68	Smart Door AUTO Lock (AUTO Close)	4-19
Lane Change Assist (LCA) system.....	4-171	Replacing the interior lamps	6-46	Seat		Smart front seat heating control... 3-14	
Rear camera.....	4-200	Resetting the average fuel economy (display of the instrument cluster).....	4-52	Ventilation and heating	3-13	Smart key	4-17
Rear camera system	4-199	Resetting the average speed (display of the instrument cluster).....	4-52	Smart front seat heating control ...	3-14	Smart key battery low	4-26
Rear cross traffic assist (RCTA) system	4-173	Resetting the driving time (display of the instrument cluster).....	4-52	Seatback Release Lever.....	3-11	Smart key warning light.....	4-47
		Resetting the mileage (display of the instrument cluster).....	4-52	Seat backrest pocket.....	3-78	Snow tire	6-52
		Resetting the sunroof	3-22	Seat belt	2-2	Special Cautions When Checking the Coolant.....	1-32
				Fastening the seat belt by a pregnant woman	2-8	SSPS warning lamp	4-39
				Load limiter	2-7	Standard type (instrument cluster).....	4-29
				Pretensioner	2-7		
				Warnings.....	2-8		

Ventilation and heating ☞ Refer to 'Seat ventilation and heating'...3-13
Voice recognition function3-69

W

Warm-up ☞ Refer to 'Engine Warm-up' 1-28
Warning due to faulty urea system, low urea solution and catalyst efficiency6-64
Warning horn ☞ Refer to 'Horn'3-66
Warning lights and indicators4-37
Warnings for self-maintenance6-60
Warning triangle5-2
Washer fluid3-46
Washing the Bumper..... 1-36
Washing Wheels 1-36
Water separator warning light4-40
Wearing the Seat Belt Correctly 1-24
Welcome light.....3-39
What is biodiesel?6-58
What is Speed Sensing Power Steering (SSPS)?4-39
What is the creep phenomenon?..... 4-117
What is the engine brake?..... 4-117
What is the fade phenomenon?1-32, 4-149

What is the kick down function? 4-118
What is the part time transfer case?4-120
What is the standing wave phenomenon?..... 1-22
What is the turbo charger?6-59
What is the vapor lock phenomenon?..... 1-32, 1-41, 4-149
What is tight cornering?4-122
What is wind buffeting?3-19, 3-21
Wheel alignment status and the balance between tires and wheels6-50
When a tire is flat5-9
When a tire is flat ☞ Refer to 'When a tire is flat'5-9
When a tow truck is unavailable (in case of emergency)5-29
 Installing the towing hook 5-29
 Using a towing rope..... 5-30
When low tire pressure is detected.....2-30
When the engine cannot be started due to depletion of the battery.....5-4
When the engine check indicator turns on5-8
When the engine is overheated so that the warning light turns on ..5-6
When the vehicle has stopped due to a failure5-36

When the water separator warning light turns on (diesel-powered vehicle)5-8
When you have rotated the tires2-30
Window (power window)3-17
 Driver seat window safety function .. 3-18
 Rear seat window lock function 3-19
Winter mode indicator4-48
WINTER / SPORT indicator lamp4-48
Wiper3-46
 Adjusting the operation speed of the windshield wiper..... 3-46
 Front windshield and washer fluid linkage..... 3-46
 Rain sensing wiper..... 3-47

No.	PART NO.	CODE NO.	PRINTING DATE	MODEL	REMARKS
1	Q261OM2305E	RS1-3OM0E-3E-300A	May 01,2023	Q261	M/Y

MUSSO & MUSSO GRAND (LHD) OWNER'S MANUAL

ISSUED BY
EXPORT SERVICE TEAM
KG Mobility Corporation

455-12, Dongsak-ro, Pyeongtaek-si,
Gyeonggi-do, 17749, Korea

TELEPHONE : 82-80-500-5582
FACSIMILE : 82-31-610-3762

NOTE: *All rights reserved. Printed in KG Mobility Corporation.
No part of this book may be used or reproduced without the
written permission of Export Service Team.*